

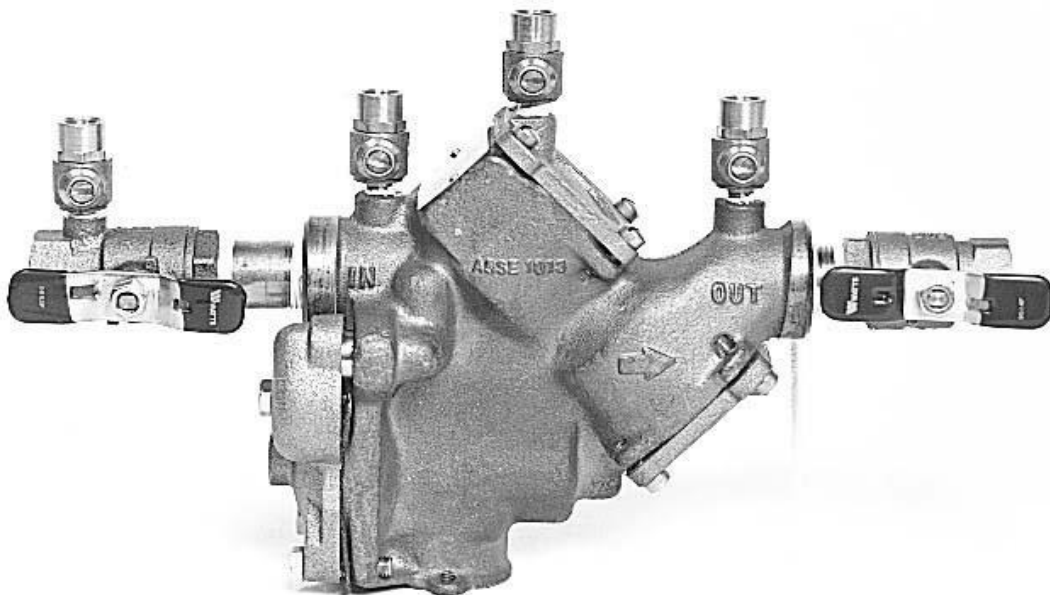

6606 Tussing Road - P.O. Box 4009
Reynoldsburg, Ohio 43068-9009
614-644-2223, option 2
BCCTrade@com.ohio.gov



Backflow Prevention & Cross-Connection

Control Manual

*For the Education of Ohio Certified Backflow Prevention
Technicians*

**Administered by: The Ohio Department of Commerce, Division of Industrial
Compliance, Backflow Section.**

Manual Development Sponsored By:

**Ohio Department of Commerce
Ohio Department of Health
Ohio Environmental Protection Agency
Ohio Rural Water Association
Operator Training Committee of Ohio, Incorporated
Ohio Section, American Water Works Association**

Original Manual Development Committee:

**David Bornino, Ohio Environmental Protection Agency
Frank Czako, APHC Backflow School
Rick Eberle, Ohio Section, American Waterworks Association
Ron Graves, Plumbers, Pipefitters and Service Technicians Local 189 JATC
Jess Jones, Operator Training Committee of Ohio, Inc.
Andy Provoznik, Ohio Rural Water association
Ralph Reeb, Ohio Department of Commerce
Terry Urbanek, Plumbers & Pipefitters Local 120
Jack Wormley, PHCC of Ohio**

****IN MEMORY...a special appreciation and thanks to Jess Jones, Operator Training Committee of Ohio Inc., for a lifetime commitment to the Water Purveyor and Backflow Industries.****

****IN MEMORY...of Ralph Reeb, Plumbing Chief, Ohio Department of Commerce, Division of Industrial Compliance.****

****IN MEMORY...of Jack Wormley, PHCC of Ohio.****

TABLE OF CONTENTS

Table of Contents	3
About This Course	4
Introduction	5
Authority in Ohio	6
Responsibility	7-9
Degree of Hazard	10
Definitions	11-17
Upstream vs Downstream	18
Atmospheric Pressure	19-20
Pressure & Elevation Head	21
Backsiphonage	22
Backpressure	23
Cross-Connections	24
Venturi Principle	25-26
Air-Gap Separation	27
ASSE 1013	28
ASSE 1015	29
ASSE 1001	30-31
ASSE 1020	32-35
Installation Requirements	36
Backflow Preventer Application	37
Backflow Prevention Devices	38-46
Barometric Piping Examples	47
Backflow Application Chart	48-50
Thermal Expansion Control	51
Barometric Loop	52
Auxiliary Water Sources	53
Interchangeable Connectors	54
Low-Suction Pressure Cut-Off	55
Ohio Basic Building Code, Plumbing	56-64
Specific BFP Applications	65
Ohio Administrative Code, OEPA	66-74
Policy on Use of Antifreeze	75
Check List for Testers	76
3-Valve Analog Test Gauge	77
ASSE 1013 Test Procedures	78-79
ASSE 1015 Test Procedures	80-81
ASSE 1020 Test Procedures	82-83
ASSE 1056 Test Procedure	84-85
5-Valve Analog Test Gauge	86
ASSE 1013 Test Procedures	87-88
ASSE 1015 Test Procedures	89-90
ASSE 1020 Test Procedures	91-92
ASSE 1056 Test Procedure	93-94
Generic Test Form	95
Test Gauge Recalibration	96
Tester Safety	97
RP Parts Drawing	98
DC Parts Drawing	99
PVB Parts Drawing	100

OHIO DEPARTMENT OF COMMERCE BACKFLOW PREVENTION MANUAL

ABOUT THIS COURSE

This backflow prevention course is intended to prepare you to test/repair the various backflow prevention devices that are used to protect the public water supply. The course consists of a combined total of 24 hours of training in the classroom and the hands-on test lab.

This manual will be used as an instructional aid for the classroom portion of the course. Your Instructor will conduct the hands-on portion of the course in the test lab. You will have the opportunity to test, disassemble, reassemble and repair various backflow prevention devices.

You will be required to attend a Re-certification Course every three years to remain current, however you may attend the re-certification course more frequently provided space is available in the classes.

Your identification card will indicate the date that your certification expires or you can check the date on the Internet at www.com.state.oh.us.

It is extremely important that a tester remember that after their expiration date they CANNOT test devices until they have taken a recertification course. Certified testers who have expired have a grace period in which they can attend a recertification class and bring their certification into active status.

OHIO DEPARTMENT OF COMMERCE BACKFLOW PREVENTION MANUAL

INTRODDUCTION

Backflow can be defined as the unintentional reversal of the normal direction of flow within a piping system. When there are cross-connections in the consumer's water distribution system, either actual or potential cross-connections, a substance can be introduced into the piping.

Substances that may backflow into a potable water distribution system can be prevented from entering the system through the proper application of an approved air-gap separation or any number of other approved backflow prevention devices that are commercially available.

This manual is intended to make you aware of the hazard associated with a backflow condition and the available methods and/or devices that may be used to properly protect the water distribution system.

Additionally the information contained in this manual and your hands-on training during the class will prepare you for the Ohio Department of Commerce "Backflow Technician" exam. Successful completion of the training course and the written test will result in a State Certification that is valid for a three year period.

Backflow prevention is a joint responsibility of the regulatory authorities, the local plumbing inspection officials, the water supplier, and the consumer. Each has a role in the eliminating the possibility of backflow.

You, the plumbing trades, are a primary figure in backflow prevention. You are the individual who sees the problem first-hand and on-site. The owner, water supplier and plumbing inspector will depend upon you to recognize a problem and bring it to their attention.

OHIO DEPARTMENT OF COMMERCE BACKFLOW PREVENTION MANUAL

AUTHORITY IN OHIO

In the State of Ohio there are two Regulatory Agencies that oversee the potable water supply.

The Ohio Environmental Protection Agency has the authority over the public water system from the source to the service connection, which is defined in Ohio Administrative Code as the outlet side of the water meter.

The water supplier acts as the enforcement officer for the Ohio EPA. The water supplier uses the containment principle of backflow prevention to protect the public water supply from backflow. The containment principle backflow prevention assembly remains under the authority of the water supplier even though it may be installed inside the building.

The Ohio Department of Commerce, Industrial Compliance Division has the authority over the consumer's water distribution system, which begins at the water meter and includes all piping and fixtures in the building.

The local plumbing official acts as the enforcement officer for the Ohio DOC. The plumbing official uses the isolation principle of backflow prevention to protect the consumer's water system.

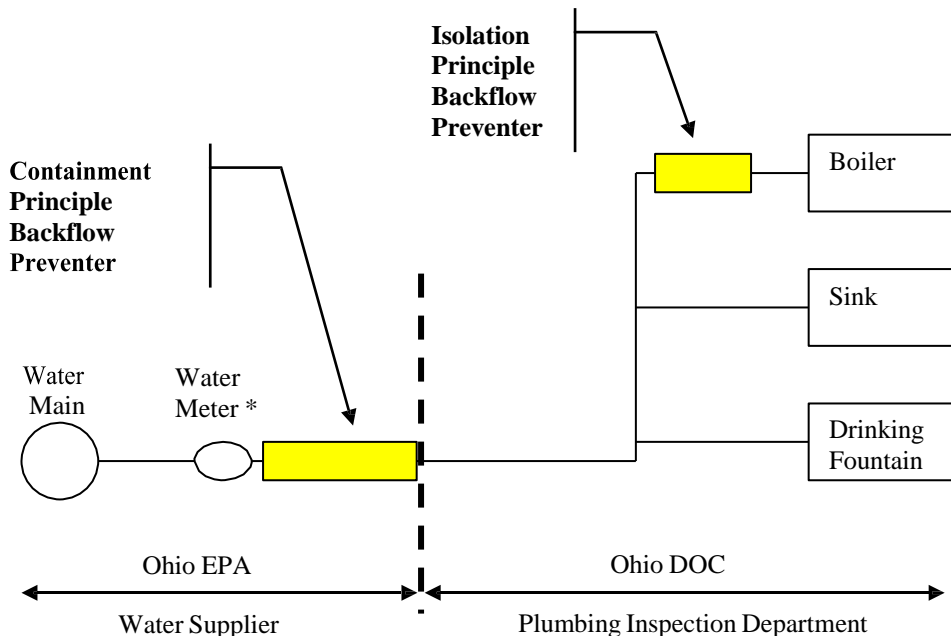

- If the water meter is installed inside the building then the containment principle backflow preventer must be installed immediately after the water meter. If the meter is installed outside the building then the containment principle backflow preventer is typically installed inside the building wall unless otherwise approved by the water supplier.

Figure 1

OHIO DEPARTMENT OF COMMERCE BACKFLOW PREVENTION MANUAL

RESPONSIBILITY

The responsibility for backflow prevention rests jointly with the supplier of water, the water consumer, the plumbing inspection agencies and the Regulatory Agencies. The Regulatory Agencies include the Ohio Environmental Protection Agency and the Ohio Department of Commerce.

Backflow prevention may be divided into two areas of protection.

One is the protection of the public potable water system, which is the responsibility of the supplier of water.

The other is the protection of the consumer's potable water system, which is the responsibility of the consumer-owner of the premises and the plumbing inspection agencies.

Supplier of Water

The supplier of water has the primary responsibility for providing the consumer with a safe and potable water supply. This responsibility begins at the source, includes all of the public water distribution system and service connections, and ends at the point of delivery to the consumer. The point of delivery to the consumer is defined in the Ohio Administrative Code as the service connection or the outlet side of the water meter.

The supplier of water must use reasonable care and vigilance to protect the public water system from hazards originating within the consumer's system that could contaminate the water in the public water system.

The Water Consumer

The water consumer has the dual responsibility of protecting the water users within his own premises and of protecting the public water system from contamination originating from conditions on the premises. This responsibility begins at the service connection and includes the entire consumer's distribution system.

The water consumer is liable for any installation on his premises that could endanger the water quality of either the public or consumer's distribution system.

OHIO DEPARTMENT OF COMMERCE BACKFLOW PREVENTION MANUAL

RESPONSIBILITY

The Plumbing Inspection Authorities

The plumbing inspection authorities have a responsibility of inspecting the consumer's water distribution system to ensure that all cross-connections within the premises are protected from backflow.

The plumbing inspection authorities are responsible for the inspection of the consumer's potable water system and ultimately share a liability with the owner and the design professional for the protection of the internal water distribution system.

The plumbing inspection authorities meet this responsibility by inspecting all new construction to ensure that all cross-connections are properly protected. They then must review the plans for all plumbing permits to ensure that no new cross-connections are installed without the appropriate protection.

The Regulatory Agencies

The regulatory agencies are responsible for enforcing Ohio's laws, rules and regulations related to backflow prevention.

The Ohio Department of Commerce oversees the plumbing inspection agencies, which have the inspection authority and responsibility to protect the users within the premises.

The Ohio Environmental Protection Agency oversees the water suppliers, who have the authority and responsibility to protect the integrity of the public water distribution system.

OHIO DEPARTMENT OF COMMERCE BACKFLOW PREVENTION MANUAL

RESPONSIBILITY

The Certified Technician's Responsibility

The technician is responsible to properly test and report the status of each device tested and accurately record the test results. He will furnish a copy of the test report to the owner or representative of the owner, to the agency requiring the test, and a retain copy for their records.

*If the technician fails in this responsibility, fraudulently fills out the test report, fails to test a device and reports it as tested, or other fraudulent activity in the testing and/or repairing of a device then there will be an advisory committee meeting(s) to determine the seriousness of the activity and could result in the action being taken as specified in the SUSPENSION GRID TABLE below.

It is the responsibility of the technician to be completely knowledgeable about regulations, rules or requirements of the Ohio Regulatory Agencies and local authorities that may be required as to registrations, requirements or additional certifications to work on specific systems before performing the testing and repair of the backflow devices.

*The technician shall review the installation of a new or existing backflow prevention device to determine that it is correct and if the device is capable of discharging water shall review the drainage system to which it discharges to determine if the drain line(s) are capable of draining said discharge completely and recording same as a comment. The comment notation should clearly indicate whether or not the drainage line(s) is capable of handling this volume of discharge without causing flooding or other damage and responsible parties should be put on notice of a design problem where damage of any nature could occur because of said discharge.

*The following table is the mandatory penalties for falsification of backflow testing documentation.

***SUSPENSION GRID FALSIFICATION OF DOCUMENTATION**

1st Offense	12 Month Suspension & Attend Recertification Class
2nd Offense	24 Month Suspension & Attend Full Certification Class No reexamination required
3rd Offense	Lifetime Suspension of Certification

*These are penalties that are assessed by the Department of Commerce and are separate from any that can or will be assessed by the Ohio EPA in their investigation of the allegations of falsification of documentation when it involves the containment backflow device.

OHIO DEPARTMENT OF COMMERCE BACKFLOW PREVENTION MANUAL

DEGREE OF HAZARD

The type of backflow prevention device that will be required at the water meter or at an individual fixture is determined by evaluating the degree of hazard that is presented.

When we speak of evaluating the degree of hazard, we are going to determine the potential for backflow to occur (can backflow happen) and the toxicity of the contaminant that could backflow (how toxic is the substance that can backflow into the piping).

The Plumbing Inspection Authority under the direction of the Ohio Department of Commerce determines the degree of hazard presented by the individual fixtures within the premises. Based upon this evaluation, they determine the appropriate isolation principle backflow prevention device that must be installed at the fixture.

The Water Supplier under the direction of the Ohio Environmental Protection Agency determines the total degree of hazard presented by the premises and determines the appropriate containment principle backflow prevention assembly that must be installed at the water meter.

Although the Ohio Department of Commerce and Ohio Environmental Protection Agency has different levels of degree of hazard, there is a correlation between the two agencies as indicated in the following chart.

Degree of Hazard Evaluation Terms

Ohio Department of Commerce

Ohio Environmental Protection Agency

Low Hazard = Pollution Hazard (aesthetically objectionable)

High Hazard = System Hazard (may cause damage to the system piping)
“ = Health Hazard (is a threat to the health of the water user)

Severe High Hazard = Severe Health Hazard (presents a threat of death)

With a recommendation for an approved air-gap separation:

1. Pump packing gland seal on a sewage lift pump
2. Any system containing ethylene glycol antifreeze

**OHIO DEPARTMENT OF COMMERCE
BACKFLOW PREVENTION MANUAL**

DEFINITIONS

<p><u>Absolute Pressure</u></p>	<p>The total pressure; gauge pressure plus atmospheric pressure. Absolute pressure is generally measured in pounds per square inch, and is indicated as pounds per square inch absolute (psia).</p>
<p><u>Air Gap</u></p>	<p>The unobstructed vertical distance through the free atmosphere between the lowest opening from any pipe or outlet supplying water to a tank, plumbing fixture, or other device, and the flood level rim of the receptacle.</p>
<p><u>Approved Air-Gap Separation</u></p>	<p>An approved air-gap separation is a distance through the free atmosphere equal to two times the nominal diameter of the supply pipe discharge opening, but never less than one inch.</p>
<p><u>Atmospheric Pressure</u></p>	<p>The pressure exerted by the weight of the atmosphere (14.7 psig) at sea level). As the elevation above sea level increases, the atmospheric pressure decreases.</p>
<p><u>Atmospheric Vacuum Breaker</u></p>	<p>A mechanical device consisting of a float check valve and an air-inlet port designed to prevent backsiphonage.</p>
<p><u>Auxiliary Water System</u></p>	<p>Any water system on or available to the premises other than the public water system. These auxiliary water systems shall include used water or water from a source other than the public water system, such as wells, cisterns or open reservoirs that are equipped with pumps or other prime movers, including gravity.</p>
<p><u>Backflow</u></p>	<p>The unintentional reversal of the normal direction of flow in a potable water system that may result in the pollution or contamination of the system by a liquid, gas, solids, or mixtures.</p>
<p><u>Backflow Prevention Device</u></p>	<p>Any device, method, or type of construction that is used to prevent a backflow condition into a potable water system.</p>
<p><u>Backpressure Backflow</u></p>	<p>A reversal of the normal direction of flow in a water system due to an increase in downstream pressure above that of the supply pressure. The greater pressure can cause a non-potable substance to backflow into the potable water system through unprotected cross-connections.</p>

**OHIO DEPARTMENT OF COMMERCE
BACKFLOW PREVENTION MANUAL**

DEFINITIONS

<p><u>Backsiphonage Backflow</u></p>	<p>A reversal of the normal direction of flow in the piping due to a drop in supply pressure, a vacuum, or a negative pressure in the supply piping.</p>
<p><u>Booster Pump</u></p>	<p>Any device which is intended to increase the in-line water pressure.</p>
<p><u>Bypass</u></p>	<p>Any arrangement of pipes, plumbing, or hoses which are designed to divert the flow around an installed backflow prevention device through which the flow normally passes.</p>
<p><u>Consumer's Water System</u></p>	<p>Any water system located on the consumer's premise that is supplied by or is connected in any manner to a public water system.</p>
<p><u>Containment Principle Backflow Prevention Device</u></p>	<p>A backflow prevention device that is installed in a water system at the outlet side of the water meter and is intended to contain the water within the building; to prevent any polluted or contaminated water from backflowing into the public water system.</p>
<p><u>Contaminant</u></p>	<p>Any liquid, solid, or gas that presents an actual threat to the health or well being of the consumer.</p>
<p><u>Contamination</u></p>	<p>The introduction of a liquid, solid, or gas that subjects the consumer to potentially lethal waterborne diseases, or illness.</p>
<p><u>Continuous Pressure</u></p>	<p>As applied to backflow prevention devices it means water pressure supplied to a device for greater than twelve (12) hours.</p>
<p><u>Critical Installation Level</u></p>	<p>The critical installation level is the prescribed height that a vacuum breaker or other appurtenance must be installed above the flood level rim of the fixture or receptacle being supplied. If this height is not maintained, then the device may not provide the intended protection. The critical installation level for a vacuum breaker is the bottom of the device when it is not indicated on the body.</p>

**OHIO DEPARTMENT OF COMMERCE
BACKFLOW PREVENTION MANUAL**

DEFINITIONS

<u>Cross Connection</u>	Any arrangement of pipes, fittings, fixtures, or devices that connects a non-potable system to a potable system. It is the piping arrangement that will allow backflow to occur.
<u>Cross Connection Control</u>	The use of a device, method, or procedure to prevent backflow into a potable water system through a cross-connection.
<u>Degree of Hazard</u>	A term used to describe the evaluation of the potential risk to health and/or the adverse effect upon a potable water system; or a determination of whether a substance is toxic or non-toxic.
<u>Differential Pressure Gauge</u>	A testing device that measures two separate pressures and indicates the difference between the two; differential pressure is indicated as pounds per square inch differential (psid).
<u>Direct Connection</u>	Any arrangement of pipes, fixtures, or devices that connects a non-potable source to a potable water system; such as a boiler feed line.
<u>Distribution System</u>	All pipes, fittings, and fixtures used to convey liquids, solids, or gases from one point to another.
<u>Double Check Valve Assembly</u>	A backflow prevention device consisting of two spring-loaded, independently acting check valves set in series, a tightly closing inlet and outlet valve, and four appropriately located test cocks.
<u>Double Check Detector Check Assembly</u>	Means a specially designed assembly composed of a line-sized approved double check valve assembly with a specific bypass water meter and a meter-sized approved double check valve assembly. The meter shall register accurately for only very low rates of flow and shall show a registration for all rates of flow.
<u>Ethylene Glycol</u>	A substance that is added to water to decrease the temperature at which the water will freeze; ethylene glycol presents a severe high hazard.
<u>Flood Level Rim</u>	The maximum height that the fluid level may reach in a vessel.

**OHIO DEPARTMENT OF COMMERCE
BACKFLOW PREVENTION MANUAL**

DEFINITIONS

<p><u>Gauge Pressure</u></p>	<p>The pounds of pressure per square inch or psig as registered on a gauge; indicating the amount of pressure above or below atmospheric pressure.</p>
<p><u>Health Hazard</u></p>	<p>A term used by the Ohio EPA to describe a degree of hazard that is defined as any condition, device or practice in a water system or its operation that creates a threat to the health and well-being of its users.</p> <p>The Ohio DOC equivalent is a high hazard.</p>
<p><u>High Hazard</u></p>	<p>An actual or potential threat of contamination of the potable water system that would present a threat to the health of the consumer.</p> <p>The Ohio EPA equivalent is a system, or health hazard.</p>
<p><u>Low Hazard</u></p>	<p>An actual or potential threat to the potable water system whereby the risk from backflow would be limited to the pollution of the potable system by an aesthetically objectionable but non-toxic substance, such as beverages, foods or other non-toxic substances.</p> <p>The Ohio EPA equivalent is a pollution hazard.</p>
<p><u>Indirect Connection</u></p>	<p>Any arrangement of pipes, fittings, or fixtures that indirectly connects a potable water system to a non-potable source, such as a flushometer valve to a water closet.</p>
<p><u>Isolation Principle Backflow Prevention Device</u></p>	<p>A backflow prevention device installed at the supply line to a fixture. It is intended to isolate that fixture from the other fixtures within the building, and to prevent backflow from that fixture into the potable water system; such as backflow prevention device on a laboratory faucet or boiler feed line.</p>
<p><u>Liability</u></p>	<p>An obligation by law, or a responsibility to perform according to generally accepted practices. SEE PAGE 10 TECHNICIAN'S RESPONSIBILITY</p>
<p><u>Negative Pressure</u></p>	<p>Any pressure that is less than the prevailing atmospheric pressure; a negative pressure in a piping system can induce a vacuum that could siphon non-potable substances into the potable water system.</p>

OHIO DEPARTMENT OF COMMERCE BACKFLOW PREVENTION MANUAL

DEFINITIONS

<u>Non Potable</u>	Any substance that is unsafe for human consumption or culinary purposes.
<u>Non Toxic Substance</u>	Any substance that may create a low degree of hazard, is a nuisance, is aesthetically objectionable, or degrades the water quality but poses no threat to the health of the consumer.
<u>Physical Disconnection (Separation)</u>	The removal of pipes, fittings, or fixtures that connect a potable water system to a non-potable source or one of questionable quality.
<u>Plumbing</u>	Any arrangement of pipes, fittings, fixtures or devices intended to move a liquid, solid, or gas from one point to another (generally within a single premises or structure).
<u>Poison</u>	A substances that can kill, permanently injure, or impair a living organism.
<u>Pollution</u>	An actual or potential threat by a substance that does not present a threat to the health of the consumer but is aesthetically objectionable or impairs the quality of the water with respect to taste, odor or color.
<u>Pollution Hazard</u>	A term used by the Ohio EPA to describe the degree of hazard of a substance that tends to degrade the water quality but poses no threat to health. The Ohio DOC equivalent is a low hazard.
<u>Potable Water</u>	Water intended for human consumption.
<u>Premises</u>	Means any building, structure, dwelling or area containing plumbing or piping supplied from a public water system.
<u>Pressure Vacuum Breaker</u>	A backflow prevention device consisting of one or two independently acting, spring-loaded check valves, and an independently acting, spring- loaded air inlet valve designed to prevent backsiphonage.

**OHIO DEPARTMENT OF COMMERCE
BACKFLOW PREVENTION MANUAL**

DEFINITIONS

<p><u>Process Fluids</u></p>	<p>Means any fluid or solution which may be chemically, biologically or otherwise contaminated or polluted in a form or concentration such as would constitute a pollution, system or health hazard if introduced into the public or a potable consumer's water system. This includes but is not limited to:</p> <ul style="list-style-type: none"> (1) Process waters (2) Used waters originating from the public water system which may have deteriorated in sanitary quality (3) Cooling waters (4) Natural waters taken from wells, lakes, ponds, or streams
<p><u>Propylene Glycol</u></p>	<p>A substance that is added to water to decrease the temperature at which the water will freeze: though an approved substance to be used around food it is considered needing high hazard protection.</p>
<p><u>Reduced Pressure Principle Backflow Preventor</u></p>	<p>A mechanical backflow prevention assembly consisting of two independently-acting, spring-loaded check valves; four appropriately located test cocks; a tightly-closing inlet and outlet valve; and a pressure relief valve mechanism located between the two check valves that is designed to maintain the pressure between the check valves at least 2 pounds lower than the supply pressure to the device.</p>
<p><u>Refusal of Service</u></p>	<p>A formal policy adopted by a governing board to enable a utility to refuse or discontinue water service where a known hazard exists and corrective measures are not taken.</p>
<p><u>Regulating Agency</u></p>	<p>Any local, state, or federal authority given the power to issue rules or regulations having the force of law for the purpose of providing uniformity in procedures or detail.</p>
<p><u>Service Connection</u></p>	<p>Is the terminal end of a water service line from the public water system. If a water meter is installed at the end of the service then the service connection means the downstream end of the water meter.</p>

OHIO DEPARTMENT OF COMMERCE BACKFLOW PREVENTION MANUAL

DEFINITIONS

<p><u>Severe Health Hazard</u></p>	<p>A term used by the Ohio EPA to describe a degree of hazard that is defined as a threat to the health of a user that could be reasonably expected to result in significant morbidity or death.</p> <p>The Ohio DOC equivalent is a severe high hazard with a recommendation for an approved air-gap separation.</p>
<p><u>Solar Heating System</u></p>	<p>A system designed to capture ambient heat from the sun and transfer that heat through a fluid medium. A chemically treated system must be protected with a reduced pressure principle backflow preventer otherwise a double check valve assembly is acceptable protection.</p>
<p><u>Submerged Inlet</u></p>	<p>An arrangement of pipes, fittings, or devices that introduces potable water into a non-potable system below the flood level rim of the receptacle being supplied.</p>
<p><u>System Hazard</u></p>	<p>A term used by the Ohio EPA to describe a threat to the physical properties of the public water system or a consumer's potable water system.</p> <p>The Ohio DOC equivalent is a high hazard.</p>
<p><u>Thermal Expansion</u></p>	<p>Thermal expansion is the physical property for water to increase in volume when it is heated.</p>
<p><u>Toxic Substance</u></p>	<p>Any liquid, solid, or gas which if introduced into the water supply would create a danger to the health and well being of the consumer.</p>
<p><u>Used Waters</u></p>	<p>Means the water supplied by the public water system after it has passed through the service connection and is no longer under the control of the water supplier.</p>
<p><u>Vacuum</u></p>	<p>A hydraulic condition created when the pressure in a system drops below the prevailing atmospheric pressure</p>
<p><u>Venturi Principle</u></p>	<p>A hydraulic principle that can create a siphon utilizing the flow of the water in the piping. The principle states that as a liquid flows through a constriction in the piping, the velocity of flow will increase and the fluid pressure will decrease at the constriction.</p>

OHIO DEPARTMENT OF COMMERCE BACKFLOW PREVENTION MANUAL

UPSTREAM VS DOWNSTREAM

Upstream always refers to the supply side (water main side) of any appurtenance connected to the water supply system.

Downstream always refers to the discharge side (user's side) of any appurtenance connected to the water supply system.

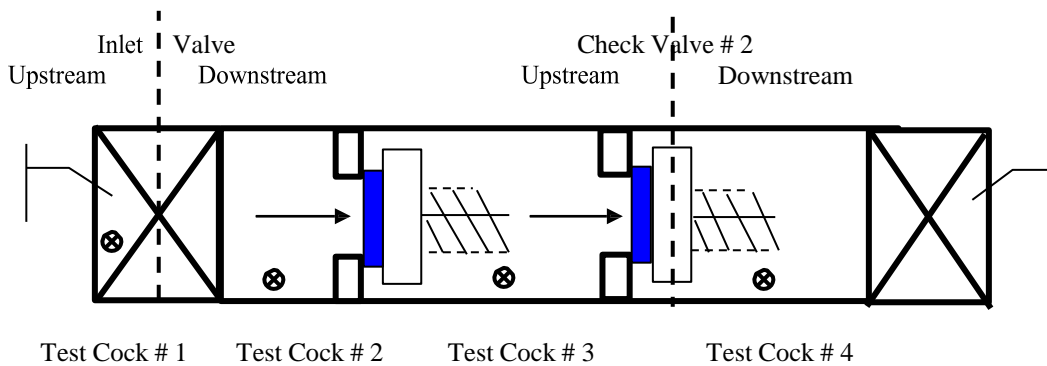
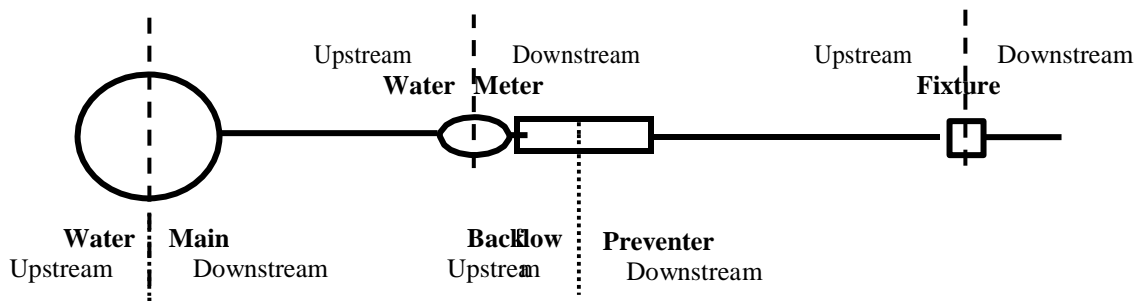

Upstream/Downstream Memory Shortcut: Up and In - Down and Out

Remember that on an ASSE 1015, 1013, 1047, or 1048:

- Test cock number 1 is always upstream of shut-off valve 1
- Test cock number 2 is always upstream of check valve 1
- Test cock number 3 is always upstream of check valve 2
- Test cock number 4 is always upstream of shut-off valve 2

OHIO DEPARTMENT OF COMMERCE BACKFLOW PREVENTION MANUAL

ATMOSPHERIC PRESSURE

The air surrounding the earth has a weight sufficient to exert a pressure of 14.7 pounds per square inch at sea level. This atmospheric pressure is equivalent to the pressure exerted by a column of water 34 feet high. Figure 4 shows the theoretical balance between atmospheric pressure and a column of water.

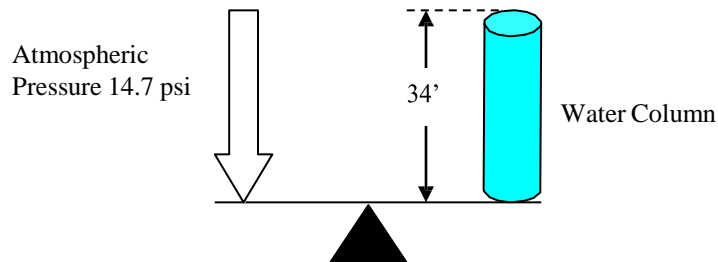
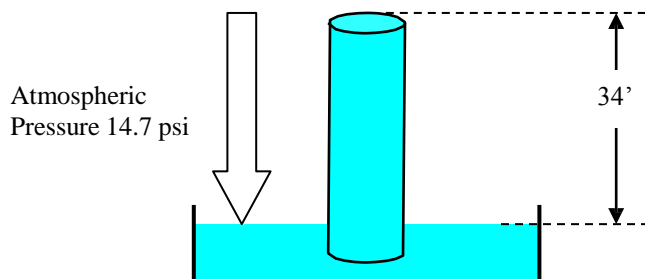

Figure 4

The balancing of forces is also shown in Figure 5. When a long tube closed at one end is filled with water and inverted in an open container of water, the water level in the tube will be higher than the water level in the open container. The weight of the atmosphere pressing down on the water surface in the container will hold the water in the tube up to a maximum elevation of 34 feet. One pound per square inch of pressure will elevate water to a height of 2.31 feet.



$$14.7 \text{ psi} \times 2.31' = 34'$$

Figure 5

OHIO DEPARTMENT OF COMMERCE BACKFLOW PREVENTION MANUAL

ATMOSPHERIC PRESSURE

Pressure less than atmospheric pressure is called negative pressure or vacuum. A vacuum can be defined as any location in a piping system where the pressure is less than the prevailing atmospheric pressure.

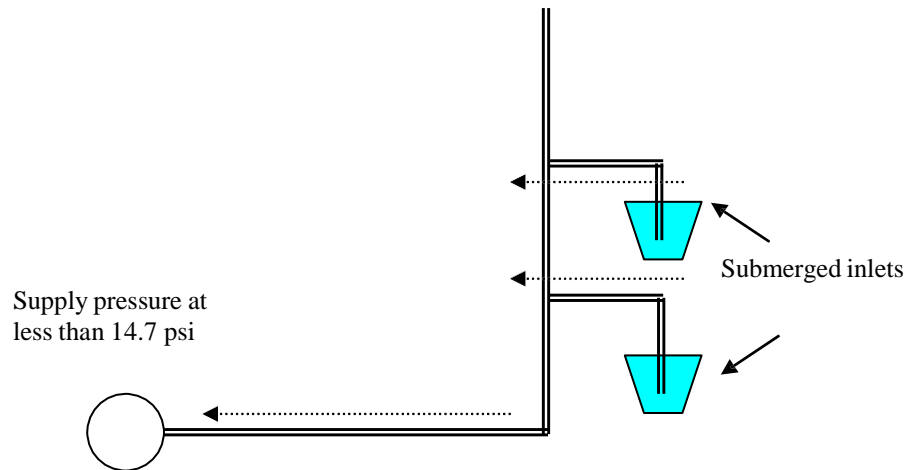

Figure 6

OHIO DEPARTMENT OF COMMERCE BACKFLOW PREVENTION MANUAL

PRESSURE & ELEVATION HEAD

Pressure head is the force, usually from a pump, that pushes the water forward. It takes one pound of pressure head to lift a column of water 2.31' or 28" high. Pressure head is diminished by frictional loss as the water travels through the pipe or a fixture, but these losses are usually minimal.

So to lift the water through the consumer's piping to the second floor would cause a loss of 1 pound of pressure for every 2.31' or 28" high that the water has to be elevated.

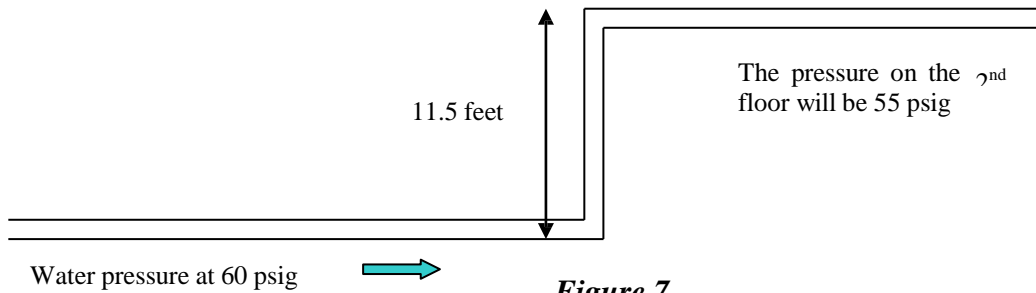

$$\text{Water pressure minus (elevation} \div 2.31') = \text{pounds of pressure lost to lift the water in the piping } 60 \text{ psig minus } (11.5' \div 2.31') = 55 \text{ psig} \quad \text{or} \quad 60 \text{ psig minus (elevation} \times .433) 4.98 = 55 \text{ psig}$$

Elevation head is the force of the weight of the water in the piping. A column of water 1' high has a pressure at its base of .433 psig. If you put another 1' column of water on top of the first column, the pressure at the base is now .866. Each additional 1' column of water adds an additional .433 psig pressure at the base

So a column of water 2.31' or 28" high exerts a force of 1 psig at its base. If you add another 2.31' column of water on top of the first column, the pressure at the base is now 2 psig; so for each additional 2.31' of water there is an additional 1 psig added at the base.

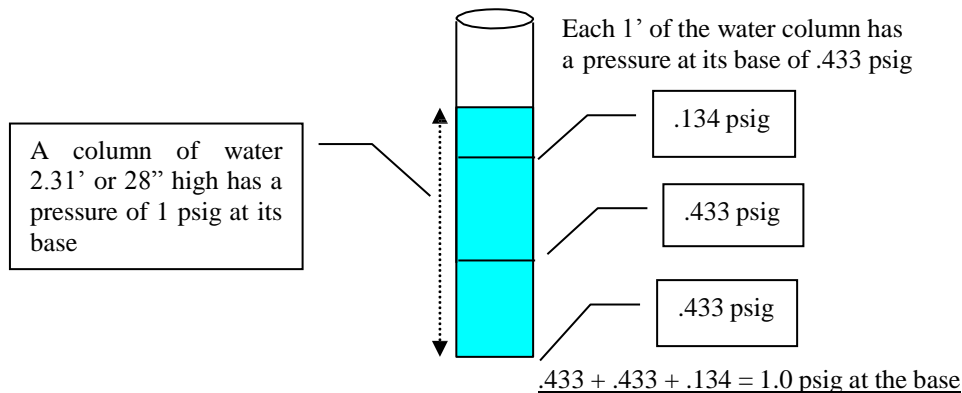

Figure 8

Pressure/Elevation Memory Shortcut: 1 Foot of Elevation equals .433 Pounds of Pressure

OHIO DEPARTMENT OF COMMERCE BACKFLOW PREVENTION MANUAL

BACKSIPHONAGE

Backsiphonage is one of the two hydraulic principles that can cause backflow to occur.

It is a reversal of the normal direction of flow in a piping system due a drop in the supply pressure, a vacuum or a negative pressure in the piping system.

Backsiphonage always results when a vacuum, a partial vacuum or a negative pressure occurs in the supply piping. A vacuum is defined as any point in a water piping system where the pressure is less than the prevailing atmospheric pressure (14.7 psi at sea level).

An unprotected cross-connection may allow a contaminant or pollutant to backflow into the potable water system due to backsiphonage.

Backsiphonage can be caused by a water main break in the public water system; by a break in the consumer's piping; if the water is turned off for maintenance or repair; if a fire hydrant is struck; if the fire department is drawing water to fight a fire; or by an abnormally heavy water use in the supply piping.

Remember that a liquid will flow in the direction of the lesser pressure. So if the pressure drops on the upstream or supply side then the direction of flow will be reversed.

Backsiphonage occurs most frequently within the consumer's system and primarily from the higher points in the building.

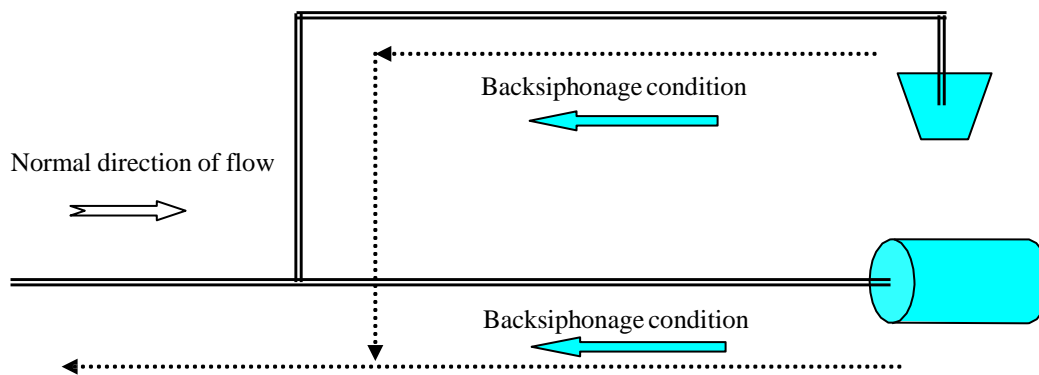

A drop in the supply pressure in the water main or in the consumer's internal piping will cause a reversal of flow in the piping due to backsiphonage.

Figure 9

OHIO DEPARTMENT OF COMMERCE BACKFLOW PREVENTION MANUAL

BACKPRESSURE

Backpressure is the other hydraulic principle that can cause backflow to occur.

It is a reversal of the normal direction of flow due to a downstream pressure that is greater than the supply pressure.

When the pressure is greater in a consumer's distribution system than the pressure in the public water system, then the water will reverse its normal direction of flow and flow towards the public water system. Unless, an isolation principle backflow prevention device has been installed at the plumbing fixture that contains the higher pressure.

Backpressure can be created by boilers, chillers, internal pumping systems, or any other system that can create a pressure that is greater than the normal supply pressure.

So if a system creates a pressure greater than the supply pressure then there will be backflow unless the appropriate isolation principle backflow prevention device is installed.

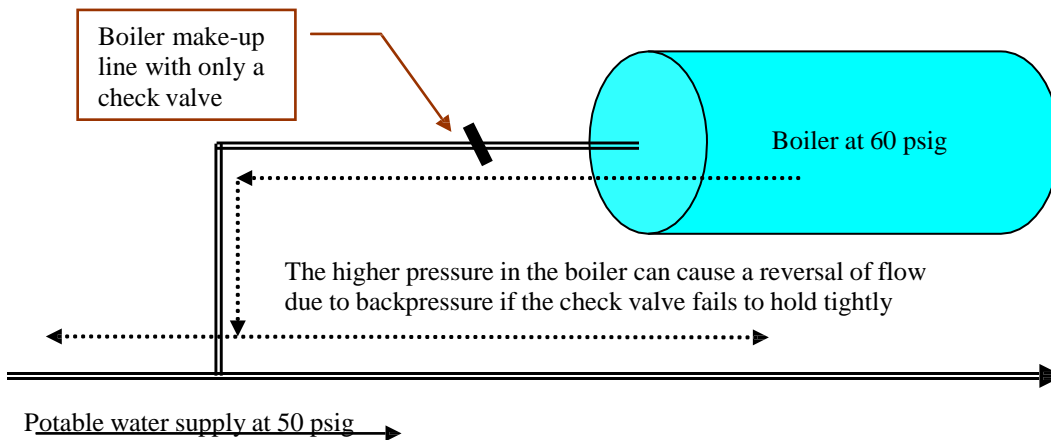

Figure 10

OHIO DEPARTMENT OF COMMERCE BACKFLOW PREVENTION MANUAL

CROSS-CONNECTIONS

A cross-connection is any connection between the potable water supply and a source of pollution or contamination. It can be permanent or temporary; direct or indirect; actual or potential.

Another definition is any arrangement whereby backflow can occur.

A cross-connection is the point at which a water-using fixture is connected to the consumer's potable water system.

Some of the more common examples are:

- boiler make-up lines
- chiller make-up lines
- tanks or vats with a submerged inlet
- x-ray & photo developing equipment
- irrigation systems
- pressure washers
- commercial grade dishwashers
- commercial grade garbage disposals or grinders
- soap, sanitizer or wax education systems
- a janitor's sink with a hose attached
- hose bibs with hose attached

OHIO DEPARTMENT OF COMMERCE BACKFLOW PREVENTION MANUAL

VENTURI PRINCIPLE

One of the basic principles of Fluid Mechanics is the Principle of Fluid Motion. The premise of this principle is that as a fluid flows through a constriction in the piping, its velocity increases which reduces the pressure at the constriction; thereby a siphon or vacuum is created at the constriction. Using this principle, a fluid may be added to the water using only atmospheric pressure.

This apparatus may be called a venturi, a suction tee, an eductor or an aspirator. The problem with this apparatus is that if a backsiphonage should occur, then the fluid being added would also be backsiphoned.

You will find this principle of eduction in use at the following applications, as well as many others:

- commercial dishwashers: used to add soap, sanitizer and rinse agents
- car washes: used to add soap and wax
- dentist offices: often used to suction saliva from the mouth
- butcher shops: used to add soap, sanitizer and degreaser to the hose used for washing the floor
- industry: used to add solvents to various dip tanks
- mortuaries: used to siphon body fluids during embalming process
- hospital autopsy rooms: used to siphon body fluids and other debris during autopsy
- residential: lawn & garden sprayers
- irrigation systems: used to add fertilizer, herbicide or insecticide

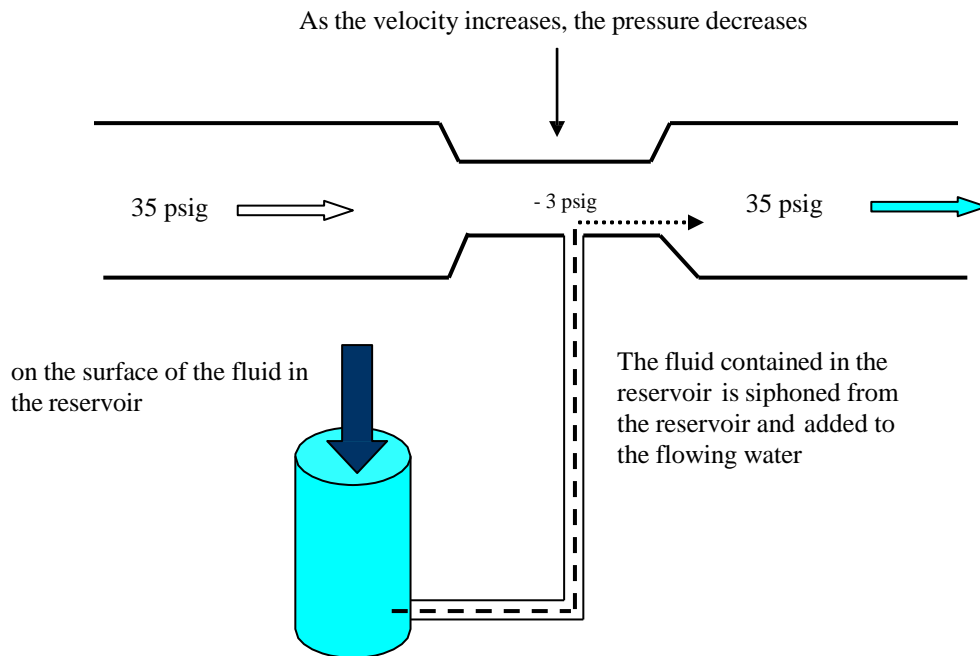

Figure 11

OHIO DEPARTMENT OF COMMERCE BACKFLOW PREVENTION MANUAL

COMMERCIAL VENTURI

A venturi is one of the more common cross-connections that you will encounter in plumbing systems. A commercial venturi can be found at:

- janitor sinks
- dishwashers
- soap eductors
- wax eductors
- hydro-aspirators
- lawn sprayers
- dental vacuum equipment

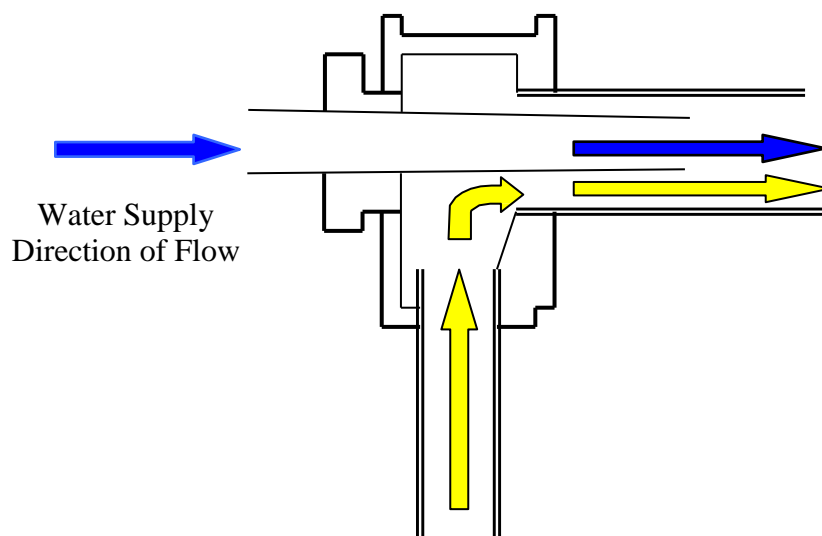

Adds a fluid through a siphon action

Figure 12

OHIO DEPARTMENT OF COMMERCE BACKFLOW PREVENTION MANUAL

APPROVED AIR-GAP SEPARATION

An air-gap separation is a physical separation between the potable water supply outlet piping and a receiving vessel or container. This separation must be an unobstructed vertical distance through the atmosphere.

The vertical separation is determined by the minimum effective diameter of the water supply outlet piping. This distance is usually two times the effective diameter, but not less than one inch. If an outlet is a distance of twice the effective opening from a wall or obstruction, then the air-gap separation must be extended to three times the effective opening. If the outlet is near two intersecting walls, then the separation should be extended to four times the effective opening.

An air-gap separation is the most basic type of backflow preventer. A properly installed air-gap separation eliminates the possibility of a cross-connection, as it creates a physical break between the potable water supply and the potential source of contamination or pollution. However, care should be taken when installing an air-gap in an area where toxic gases are present and may be drawn into the supply piping.

An air-gap separation must be inspected at least every twelve months just like any other method of mechanical backflow prevention.

It is critical that the air-gap not be defeated through the addition of a hose or extended piping. It should be noted that once potable water leaves the distribution system, the system pressure within the receiving vessel becomes atmospheric or zero (0 psig). The user may find it necessary to install a pump to re-pressurize a plumbing system downstream of the tank.

Consult ANSI Standard A112.1.2, "Air-Gaps in Plumbing Systems" for more information.

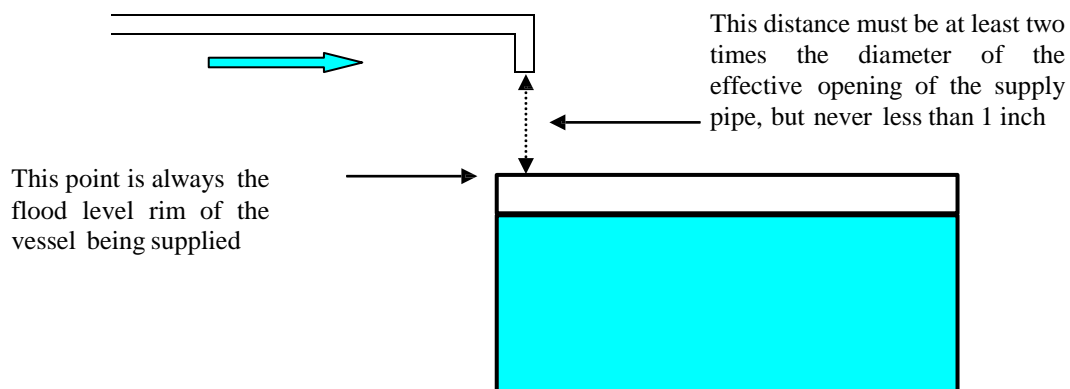

Figure 13

OHIO DEPARTMENT OF COMMERCE BACKFLOW PREVENTION MANUAL

REDUCED PRESSURE PRINCIPLE BACKFLOW PREVENTER

This backflow preventer is an assembly of several components. It has inlet and outlet shut-off valves and four appropriately located test cocks to test its operation. Two check valves are located between the shut-off valves that are spring loaded to a normally closed position and a differential pressure relief valve is located between the check valves. The relief valve is spring loaded to a normally open position so a constant discharge of water indicates a malfunction within the assembly.

These assemblies must be installed where they are not subject to flooding, may not be installed in a pit and an air-gap separation must be maintained at the relief valve discharge port.

The assembly may be used under continuous pressure, and is effective against either backpressure or backsiphonage. This assembly is designed to be used as protection against a high hazard; but may be used on low hazard applications as well. It must be tested at the time of installation and at least every twelve months thereafter. An occasional discharge of water from the relief valve port usually indicates that the device is operating properly.

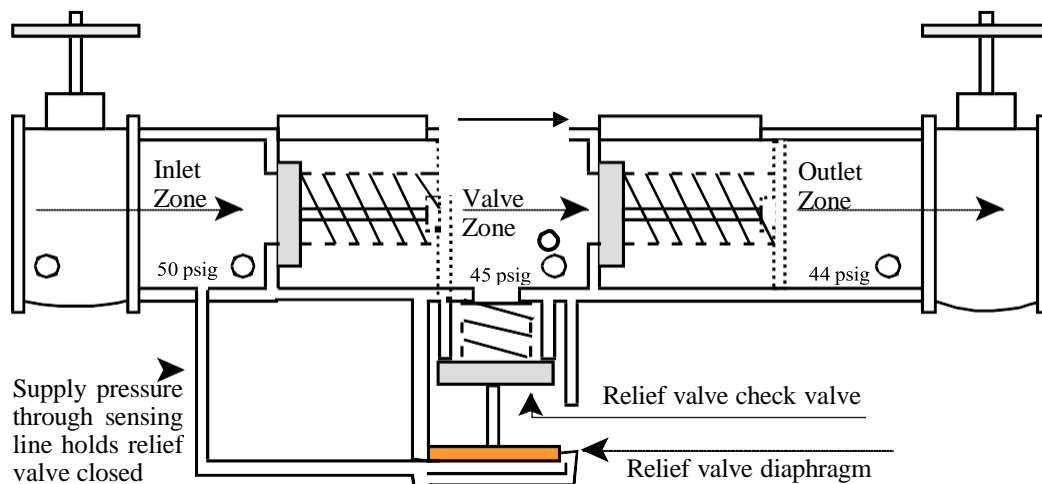

○ = test
cocks

TEST POINT	MINIMUM TEST REQUIREMENT
Check valve number 1	To pass the test it must create a loss equal to or greater than the relief valve opening point plus 3 psig
Differential pressure relief valve	The relief valve must vent water before the pressure in the intermediate zone comes within a minimum 2 psig of the supply pressure
Check valve number 2	Must hold tightly against reverse flow (backpressure)
Shut-off valve number 2	Must be drip-tight

OHIO DEPARTMENT OF COMMERCE BACKFLOW PREVENTION

DOUBLE CHECK VALVE ASSEMBLY

This assembly of components consists of an inlet and outlet shut-off valves, four appropriately located test cocks to test its operation without removal from the piping, and two independently-acting check valves that are force loaded to a normally closed position. This means that both check valves will be closed when there is no downstream water demand. If the assembly does not contain all of the components described above, then it is not an approved assembly.

The assembly may be used under continuous pressure, and is effective against either backpressure or backsiphonage.

This assembly may be used only where there is only a low hazard potential to the potable water supply. If both check valves should fail, it is then possible for a contaminant to backflow into the potable water supply.

The primary limitation of this device is that there is no visible means to indicate a failure. If either or both check valves fail then the failure will not be discovered until the device is tested. It must be tested at the time of installation and at least every twelve months thereafter.

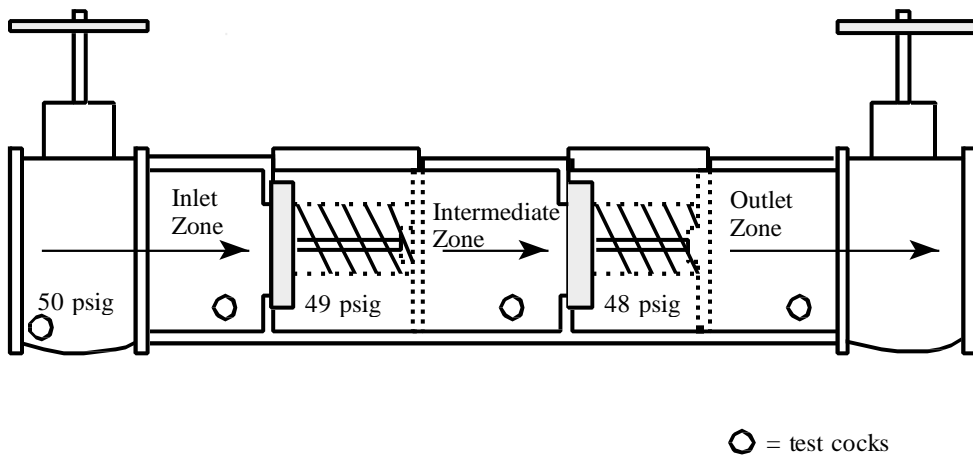

1. Under flow conditions, both checks should be open.
2. Under no flow conditions, both checks should close tightly.
3. Under backpressure or backsiphonage conditions, both checks should close tightly.

TEST POINT	MINIMUM TEST REQUIREMENT
Check valve number 1	Must create a minimum 1 psig pressure loss
Check valve number 2	Must create a minimum 1 psig pressure loss
Shutoff valve number 2	Must be drip-tight

OHIO DEPARTMENT OF COMMERCE BACKFLOW PREVENTION MANUAL

ATMOSPHERIC VACUUM BREAKER

A common characteristic of any vacuum breaker is that this device is designed to prevent only one type of backflow – backsiphonage. The AVB design consists of a combination check valve and air- inlet valve that admits atmosphere into the downstream piping. When the atmospheric air is admitted, it breaks the vacuum to prevent the backsiphonage of contaminant or pollutant into the potable water supply.

Although this device may seem simple in design, the installation guidelines must be followed to ensure a proper installation. An atmospheric vacuum breaker:

- Must be installed a minimum of 6” above the highest point of downstream usage or elevated piping (this is called the critical installation level)
- If the critical installation level is not indicated on the atmospheric vacuum breaker then the critical installation level is measured from the base of the body
- Must be installed in an upright position
- Must not be subjected to any type of backpressure
- Must not have a control or shut-off valve installed at the outlet or downstream of the device
- Must not be subjected to continuous pressure or supply pressure for periods longer than 12 hours

These devices should be tested and maintained periodically to ensure their continued operation.

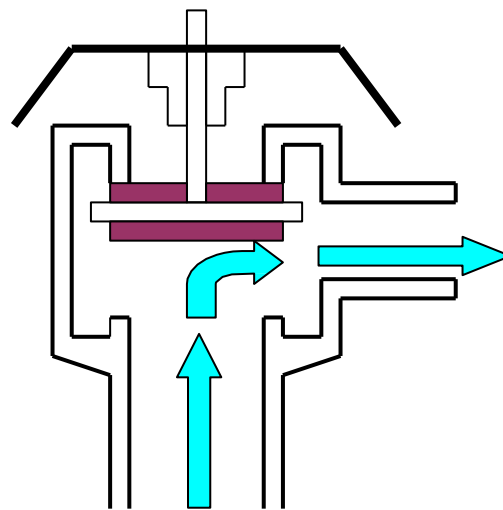

Flow Conditions

Figure 16

1. There is flow downstream
2. The check valve/air-inlet valve is held closed by the water pressure

**OHIO DEPARTMENT OF COMMERCE
BACKFLOW PREVENTION MANUAL**

ATMOSPHERIC VACUUM BREAKER

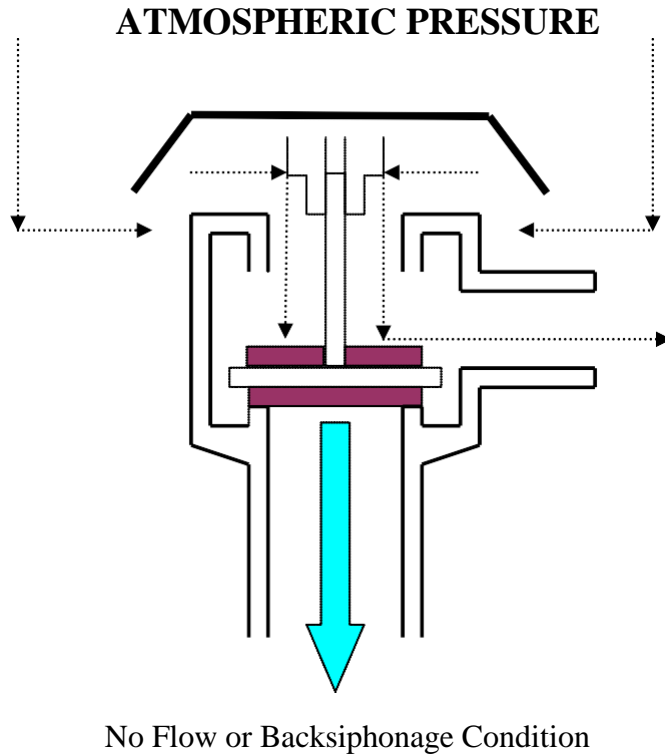

1. There is no flow downstream
2. The check valve/air-inlet valve falls closed due to gravity

OHIO DEPARTMENT OF COMMERCE BACKFLOW PREVENTION MANUAL

PRESSURE VACUUM BREAKER

Pressure vacuum breaker assemblies two-inch and smaller contain inlet and outlet shut-off valves. It has two appropriately located test cocks for testing purposes; a check valve located downstream of the inlet valve that is spring loaded to a normally closed position; and an air inlet valve that is spring loaded to a normally open position.

When water flows through the assembly, the check valve will open and water pressure will close the air inlet valve to keep atmospheric pressure from entering the device.

When there is no flow or a backsiphonage condition, the check valve will close. As the water pressure inside the valve body decreases to the loading or tension of the air inlet valve spring, the valve will open to atmosphere which allows air to enter the downstream plumbing system thereby preventing backsiphonage.

The critical installation level is at least twelve inches above the highest point of downstream use or piping. This is an important operational limitation of this assembly.

This vacuum breaker is called a “pressure” vacuum breaker because it will operate under continuous pressure conditions.

The installation guidelines must be followed to ensure a proper installation. A pressure vacuum breaker:

- Must be installed a minimum of 12” above the highest point of downstream usage or elevated piping (this is called the critical installation level)
- If the critical installation level is not indicated on the atmospheric vacuum breaker then the critical installation level is measured from the base of the body
- Must be installed in an upright position
- Must not be subjected to any type of backpressure
- May have a control or shut-off valve installed downstream of the device
- May be subjected to continuous pressure

OHIO DEPARTMENT OF COMMERCE BACKFLOW PREVENTION MANUAL

PRESSURE VACUUM BREAKER

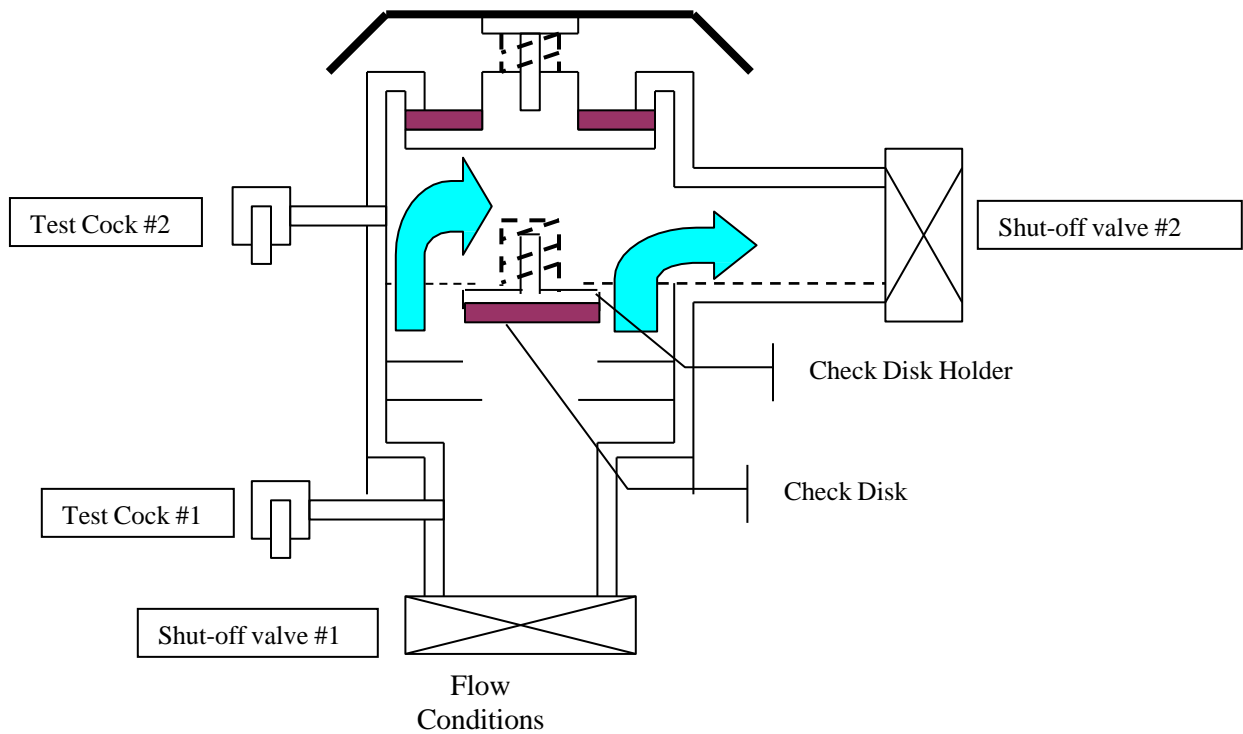
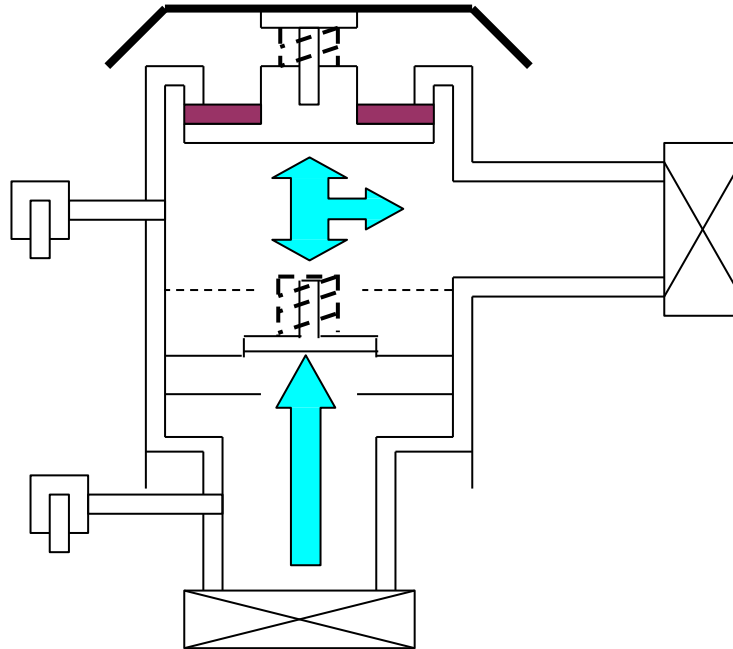

Figure 18

1. There is flow downstream
2. The spring-loaded check valve is held open by the water pressure
3. The spring-loaded air-inlet valve is held closed by the water pressure

**OHIO DEPARTMENT OF COMMERCE
BACKFLOW PREVENTION MANUAL**

PRESSURE VACUUM BREAKER



No Flow Conditions

Figure 19

1. There is no flow downstream
2. The air-inlet valve is held closed by the water pressure in the body
3. The check valve is pushed closed by the spring

**OHIO DEPARTMENT OF COMMERCE
BACKFLOW PREVENTION MANUAL**

PRESSURE VACUUM BREAKER

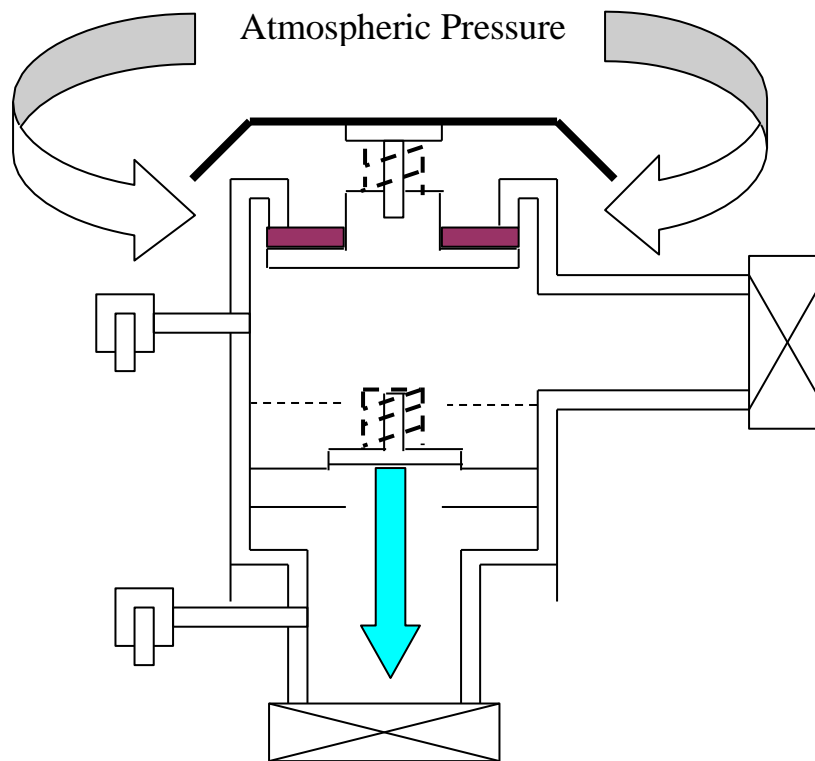

Backsiphonage Conditions

Figure 20

1. There is no flow downstream
2. The check valve is held closed by the spring
3. The air inlet valve will be held closed by the water pressure in the body, unless the check valve fails to hold tightly under backsiphonage conditions at which time the air inlet valve will open

OHIO DEPARTMENT OF COMMERCE BACKFLOW PREVENTION MANUAL

INSTALLATION REQUIREMENTS CONTAINMENT DEVICES

It is your responsibility as the installer to be familiar with the local codes or regulations regarding the proper installation of a containment backflow prevention device. It is recommended that you consult with the water supplier before installing a containment device.

The installation requirements for a containment principle backflow prevention device are normally determined by the local water supplier. The following are a few of the typical requirements.

- a containment device must be approved by the water supplier before installation, most water suppliers accept the devices that meet ASSE, USC, CSA or AWWA standards
- must be installed in a horizontal position
- must be 12" to 36" off of the floor
- test cocks must be facing into the room if they are side-mounted on the device
- must be installed in an area free of noxious fumes (for tester safety)
- must be accessible for inspection, testing and maintenance
- an ASSE 1013 or 1047 may not be installed in a pit (due to the possibility of flooding of the pit)
- you may not make a direct connection to the relief valve on an ASSE 1013 or ASSE 1047
- as ASSE 1015 or 1048 may be installed in a pit if approved by the local water supplier
- you may not install an unprotected bypass around any backflow prevention device (there must be equal protection on the bypass line) A bypass line may also be called a manifold, parallel, dual or tandem setting.

The installation requirements for an isolation principle backflow prevention device are normally determined by the Ohio plumbing code and the local plumbing inspection authorities.

Since there are few rules regarding the installation of isolation principle devices and if there are no requirements by the local Plumbing Authorities, the Plumbing Unit of the Ohio Department of Commerce suggests that you install an isolation device in accordance with the manufacturer's recommendations.

It is in your best interest to be familiar with the installation requirements because you can eliminate unnecessary return trips to correct an improper installation.

If you are unsure of the local requirements, then you should contact the water supplier or plumbing inspection authority for direction before you install the device.

OHIO DEPARTMENT OF COMMERCE BACKFLOW PREVENTION MANUAL

BACKFLOW PREVENTER APPLICATION

ASSEMBLIES INSTALLED AS CONTAINMENT PROTECTION

The Ohio EPA recognizes only four types of backflow prevention assemblies for use as a containment principle protection, the double check valve assembly, the reduced pressure principle backflow preventer, the double check detector check assembly and the reduced pressure detector check assembly.

Additionally, the Ohio EPA recognizes a properly installed pressure vacuum breaker as acceptable backflow prevention protection for a residential irrigation system that has no pumps or additives.

DEVICES INSTALLED AS ISOLATION PROTECTION

The Ohio Department of Commerce, Industrial Compliance Division recognizes those backflow prevention devices that have obtained the American Society of Sanitary Engineering (ASSE) seal authorization approval for use as an isolation principle backflow prevention protection.

The ASSE Standard Number will be stamped into the body of the device or printed on a metal plate that is attached to the device.

The ASSE seal authorization approval list may be viewed at www.asse-plumbing.org.

In order to select the appropriate backflow prevention device for an application, it is necessary that you understand the appropriate application and the limitations of the various devices.

The following informational charts indicate the available devices and their application.

OHIO DEPARTMENT OF COMMERCE BACKFLOW PREVENTION MANUAL

BACKFLOW PREVENTION DEVICES

Pipe Applied Atmospheric Vacuum Breaker

Standard Number: ASSE 1001
Protection Provided: Backsiphonage Only
Hazard Level: High or Low Hazard
Limitation: May not be used under continuous pressure conditions
Must be installed at least 6" above the highest downstream use
May not have a downstream shut-off valve
Construction: A combination check valve / air inlet valve



Anti-Siphon Fill Valve (Ballcock) for Water Closet Flush Tank

Standard Number: ASSE 1002
Protection Provided: Backsiphonage Only
Hazard Level: High or Low Hazard
Limitation:
Construction: Float operated anti-siphon toilet ballcock

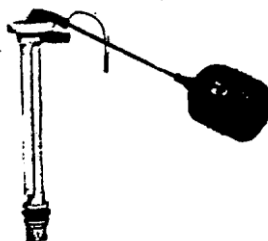

OHIO DEPARTMENT OF COMMERCE BACKFLOW PREVENTION MANUAL

BACKFLOW PREVENTION DEVICES

Hose Connection Vacuum Breaker

Standard Number: ASSE 1011
Protection Provided: Backsiphonage and Low Head Backpressure
Hazard Level: High or Low Hazard
Limitation: May not be used under continuous pressure conditions
Construction: A single check valve & an atmospheric vent valve

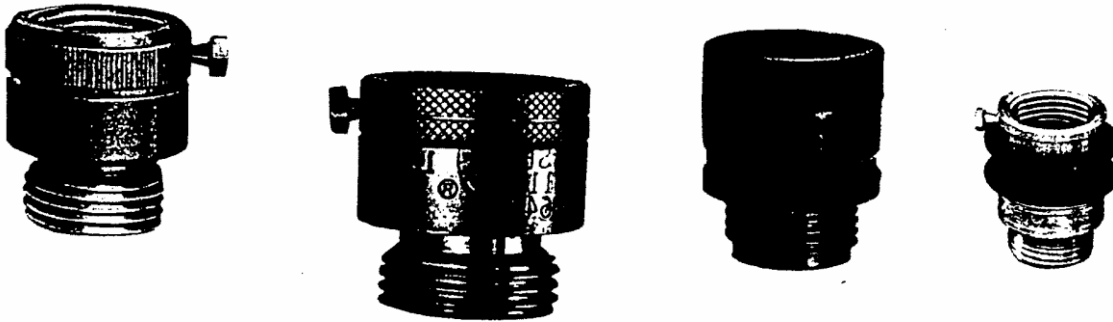

Backflow Preventer with Intermediate Atmospheric Vent

Standard Number: ASSE 1012
Protection Provided: Backsiphonage and Backpressure
Hazard Level: Low Hazard Only
Limitation: Low pressure only
Vent on device to be in down position with approved air-gap separation at the vent
Construction: Two independently operating check valves with a vent between the check valves that opens to atmosphere



OHIO DEPARTMENT OF COMMERCE BACKFLOW PREVENTION MANUAL

BACKFLOW PREVENTION DEVICES

Reduced Pressure Principle Backflow Preventer

Standard Number:	ASSE 1013
Protection Provided:	Backsiphonage and Backpressure
Hazard Level:	High or Low Hazard
Limitation:	May not be installed in a pit Must maintain an approved air-gap separation at the relief valve vent port
Construction:	Two independently-acting check valves, a hydraulic relief valve between the check valves, tightly closing inlet & outlet valves, four appropriately located test cocks

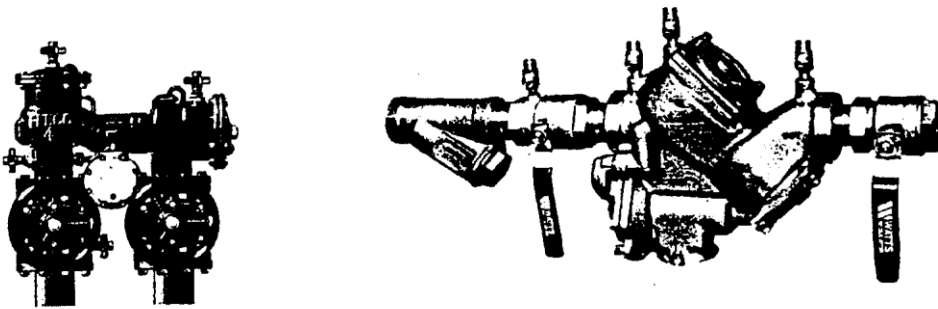

Reduced Pressure Principle Detector Check Assembly

Standard Number:	ASSE 1047
Protection Provided:	Backsiphonage and Backpressure
Hazard Level:	High or Low Hazard
Limitation:	Used for fire protection systems containing any additive or a connection to stored water or an auxiliary water source May not be installed in a pit
Construction:	Two reduced pressure assemblies installed in parallel, four test cocks on each assembly, and a bypass meter to detect low water flow usage

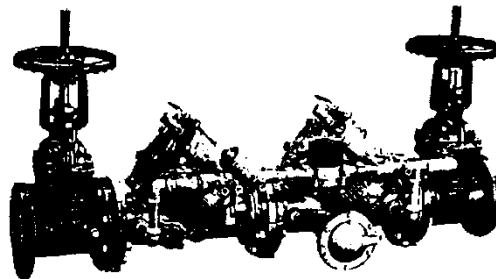

OHIO DEPARTMENT OF COMMERCE BACKFLOW PREVENTION MANUAL

BACKFLOW PREVENTION DEVICES

Double Check Backflow Prevention Assembly

Standard Number: ASSE 1015
Protection Provided: Backsiphonage and Backpressure
Hazard Level: Low Hazard Only
Limitation:
Construction: Two independently-acting check valves, tightly closing inlet & outlet valves, and four appropriately located test cocks

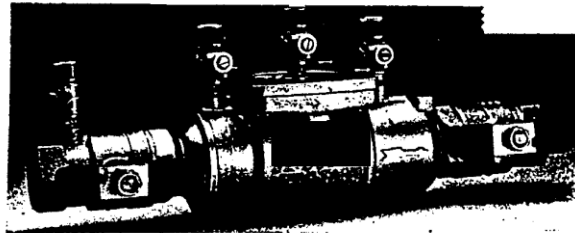
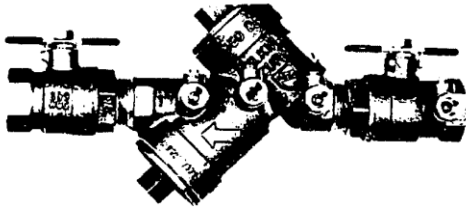

Double Check Detector Check Assembly

Standard Number: ASSE 1048
Protection Provided: Backsiphonage and Backpressure
Hazard Level: Low Hazard Only
Limitation: Used for fire protection systems containing no additives, storage or auxiliary water connection
Construction: Two double check valve assemblies installed in parallel, four test cocks on each assembly, and a bypass meter to detect low water flow usage

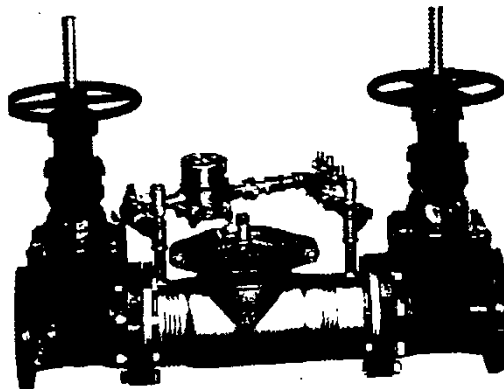

OHIO DEPARTMENT OF COMMERCE BACKFLOW PREVENTION MANUAL

BACKFLOW PREVENTION DEVICES

Vacuum Breaker Wall Hydrant, Freeze Resistant, Automatic Draining Type

Standard Number: ASSE 1019
Protection Provided: Backsiphonage and Low Head Backpressure
Hazard Level: High or Low Hazard
Limitation: May not be used under continuous pressure conditions
Construction: A wall hydrant with an internal vent valve and a means to drain the barrel to prevent freezing

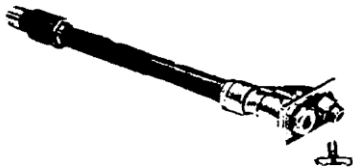

Pressure Vacuum Breaker Assembly

Standard Number: ASSE 1020
Protection Provided: Backsiphonage Only
Hazard Level: High or Low Hazard
Limitation: The critical installation level is 12" above the highest downstream use
Construction: A spring-loaded check valve and an independently-acting, spring-loaded air inlet valve, and tightly closing inlet & outlet valves

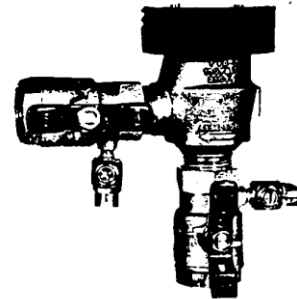
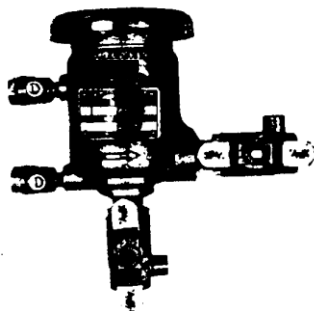
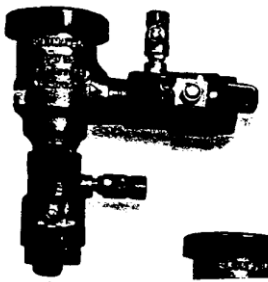

OHIO DEPARTMENT OF COMMERCE BACKFLOW PREVENTION MANUAL

BACKFLOW PREVENTION DEVICES

Backflow Preventer for Carbonated Beverage Machine

Standard Number: ASSE 1022
Protection Provided: Backsiphonage and Backpressure
Hazard Level: Low Hazard Only, Required on the potable water supply line to Post-Mix Carbonated Beverage Dispensers
Limitation:
Construction: Two independently acting check valves with a vent to atmosphere



Dual Check Valve Type Backflow Preventer

Standard Number: ASSE 1024
Protection Provided: Backsiphonage and Backpressure
Hazard Level: Low Hazard Only
Limitation:
Construction: Two independently acting check valves



OHIO DEPARTMENT OF COMMERCE BACKFLOW PREVENTION MANUAL

BACKFLOW PREVENTION DEVICES

Dual Check Valve Type Backflow Preventer for Post Mix Carbonated Beverage Dispensers

Standard Number: ASSE 1032
Protection Provided: Backsiphonage and Backpressure
Hazard Level: Low Hazard Only
Limitation:
Construction: Two independently acting check valves, usually found inside the dispenser

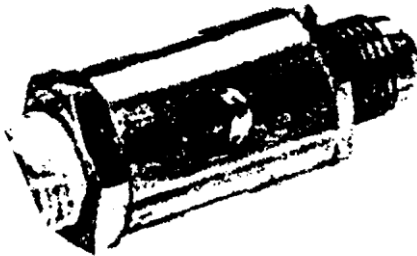

Laboratory Faucet Backflow Preventer, Vacuum Breaker

Standard Number: ASSE 1035
Protection Provided: Backsiphonage and Low Head Backpressure
Hazard Level: High or Low Hazard
Limitation: May not be used under continuous pressure conditions
Construction: Two independently acting check valves with a means to vent to atmosphere under backsiphonage conditions

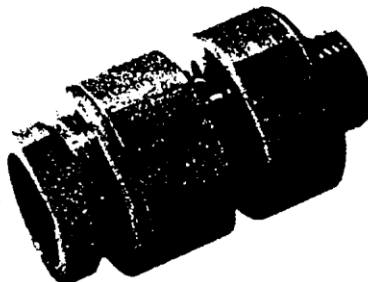

OHIO DEPARTMENT OF COMMERCE BACKFLOW PREVENTION MANUAL

BACKFLOW PREVENTION DEVICES

Hose Connection Backflow Preventer, Vacuum Breaker

Standard Number: ASSE 1052
Protection Provided: Backsiphonage and Low Head Backpressure
Hazard Level: High or Low Hazard
Limitation: May not be used under continuous pressure conditions
Construction: Two independently acting check valves with an intermediate vent to the atmosphere

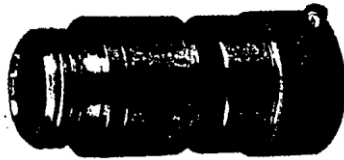

Backsiphonage Vacuum Breaker, Spill-Proof

Standard Number: ASSE 1056
Protection Provided: Backsiphonage Only
Hazard Level: High or Low Hazard
Limitation: The critical installation level is 6" above the highest downstream use or 1" when equipment mounted
Construction: At least one check valve and an automatic vent valve to atmosphere, tightly closing inlet & outlet valves, and a test cock



OHIO DEPARTMENT OF COMMERCE BACKFLOW PREVENTION MANUAL

BACKFLOW PREVENTION DEVICES

Air-Gap Separation

Standard Number: ANSI A112.1.2
Protection Provided: Backsiphonage and Backpressure
Hazard Level: High or Low Hazard
Limitation: Must be at least two times the nominal diameter of the discharge piping but never less than one inch
Construction: A physical separation through the free atmosphere measured from the opening of the discharge piping to the flood level rim of the receiving vessel

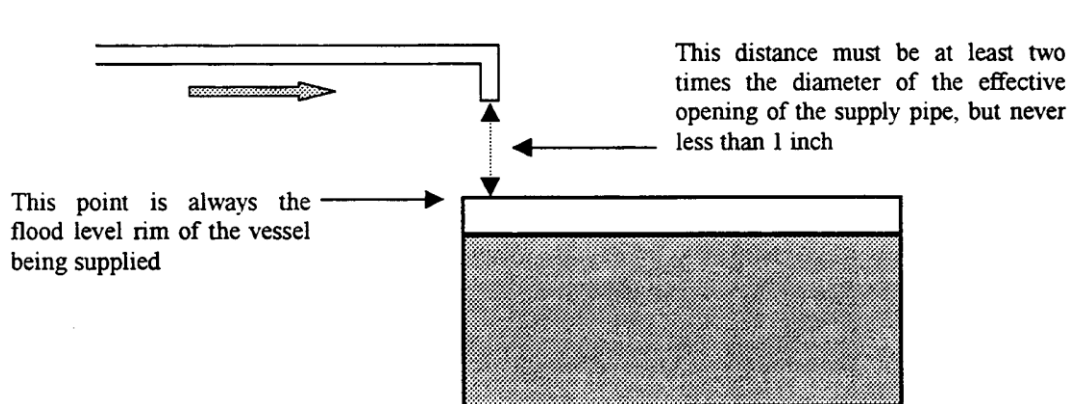

**OHIO DEPARTMENT OF COMMERCE
BACKFLOW PREVENTION MANUAL**

BACKFLOW PREVENTION DEVICES

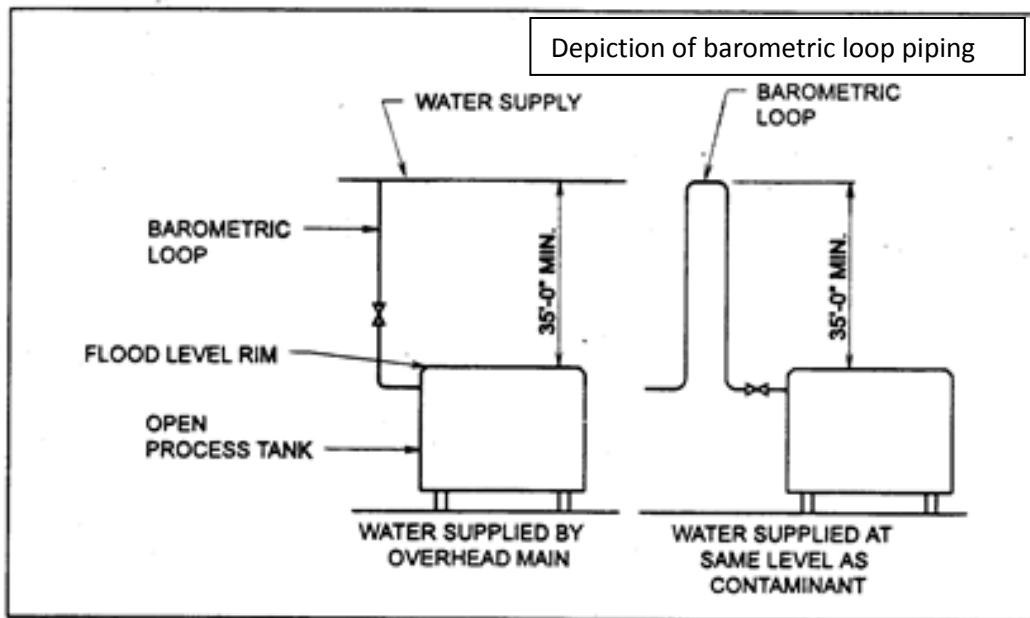

BAROMETRIC LOOP

BACKFLOW PREVENTION APPLICATION CHART

DEVICE	ASSE NO.	HAZARD LEVEL	PROTECTION PROVIDED
Air Gap Separation	ANSI A112.1	Severe High, High or Low Hazard	Backsiphonage / Backpressure
Pipe Applied Atmospheric Type Vacuum Breaker	ASSE 1001 1/4" - 4"	High or Low Hazard	Backsiphonage Only No continuous pressure
Anti-siphon Fill Valve (Ballcock) for Water Closet Flush Tank	ASSE 1002	High or Low Hazard	Backsiphonage Only
Hose Connection Vacuum Breaker	ASSE 1011 1/2", 3/4", 1"	High or Low Hazard	Backsiphonage Low Head Backpressure No continuous pressure
Backflow Preventer with Intermediate Atmospheric Vent	ASSE 1012 1/4" - 3/4"	Low Hazard Low Pressure	Backsiphonage / Backpressure
Reduced Pressure Principle Backflow Preventer	ASSE 1013 3/8" - 10"	High or Low Hazard	Backsiphonage / Backpressure
Reduced Pressure Principle Detector Check Assembly	ASSE 1047 1 1/2" - 10"	High or Low Hazard fire sprinkler systems	Backsiphonage / Backpressure
Double Check Backflow Prevention Assembly	ASSE 1015 3/8" - 10"	Low Hazard Only	Backsiphonage / Backpressure
Double Check Detector Check Assembly	ASSE 1048 1 1/2" - 10"	Low Hazard Only fire sprinkler systems	Backsiphonage / Backpressure
Vacuum Breaker Wall Hydrant, Freeze-Resistant, Automatic Draining Type	ASSE 1019 3/4" & 1"	High or Low Hazard	Backsiphonage Low Head Backpressure No continuous pressure
Pressure Vacuum Breaker Assembly	ASSE 1020 1/2" - 2"	High or Low Hazard	Backsiphonage Only
Backflow Preventer for Carbonated Beverage Machine	ASSE 1022 1/4" - 3/8"	Low Hazard Only	Backsiphonage / Backpressure
Dual Check Valve Type Backflow Preventer	ASSE 1024 Sizes 1/4" - 1"	Low Hazard Only	Backsiphonage / Backpressure
Dual Check Valve Type Backflow Preventer for Post- Mix Beverage Dispenser	ASSE 1032 1/4" - 3/8"	Low Hazard Only	Backsiphonage / Backpressure
Laboratory Faucet Backflow Preventer, Vacuum Breaker	ASSE 1035 3/8"	High or Low Hazard	Backsiphonage Low Head Backpressure No continuous pressure
Hose Connection Backflow Preventer, Vacuum Breaker	ASSE 1052 1/2" - 1"	High or Low Hazard	Backsiphonage Low Head Backpressure
Backsiphonage Vacuum Breaker, Spill-Proof	ASSE 1056 1/8" - 2"	High or Low Hazard	Backsiphonage Only

BACKFLOW PREVENTION APPLICATION CHART

INSTALLATION	EXAMPLES OF INSTALLATION
Should be used whenever possible, is the only absolute means of preventing backflow	Lavatories, process tanks, sinks, bathtubs, and cooling towers
May not have a downstream valve since this device is not designed to operate under continuous pressure	Irrigation systems, process tanks, dishwashers, and soap dispensers
Tank type water closet or flush tank for urinals	Gravity fill water closet or flush tank type urinals
Low head backpressure is intended to mean negligible backpressure in the 1.0 psi to 2.0 psi range, no continuous pressure over 12 hrs	Hose bib connections
Low hazard cross-connections under continuous pressure, but may not be subject to high-pressure backpressure	Low-pressure boilers or cooling towers containing no additives
Cross-connections subject to backsiphonage or backpressure and operating under continuous pressure	Main supply lines, commercial or chemically treated boilers or chillers, main hospital lines and equipment, tanks with submerged inlets
Installed on a fire protection system containing any additive, even a food-grade additive	Chemically charged fire protection systems (such as Foamite), or a fire protection system that contains any additive or anti-freeze
Installed to prevent the backflow of a substance that would not present a hazard to health	Main supply lines, food cookers, tanks or vats containing non-toxic substances
Installed on a fire protection system that contains only the public water, has no booster pump, storage, or auxiliary water	Non-chemically charged and/or non-toxic fire protection systems; a fire sprinkler system that is filled with water from the public water supply
Low head backpressure is intended to mean negligible backpressure in the 1.0 psi to 2.0 psi range, no continuous pressure over 12 hrs.	Wall hydrant hose bib
Continuous pressure is OK because the air-inlet and check valve are spring-loaded	Irrigation systems, plating tanks, livestock watering systems, supply to a submerged inlet
Constructed of non-copper material, must include a strainer	Installed on the water supply line to carbonated beverage dispensers prior to the carbonating point, no copper beyond this device
Low hazard cross-connections, continuous pressure, backsiphonage and backpressure	Residential water service connections, individual outlets
Independently-acting check valves	Installed inside the post-mix type carbonated beverage dispensers, by the beverage maintenance personnel
Low head backpressure is intended to mean negligible backpressure in the 1.0 psi to 2.0 psi range, no continuous pressure over 12 hrs	Laboratory faucets
Low head backpressure is intended to mean negligible backpressure in the 1.0 psi to 2.0 psi range, no continuous pressure over 12 hrs	Hose bib connections
Used in areas where water spillage may present a problem	X-ray or photo developing machines

OHIO DEPARTMENT OF COMMERCE BACKFLOW PREVENTION MANUAL

APPLICATION CHART

You will have to understand and memorize the information on the backflow prevention application chart to properly utilize the protection provided by the various types of devices.

Assume that all backflow prevention devices operate under the these conditions

Backpressure	Backsiphonage
High Hazard	Low Hazard

Any backflow prevention device with the word dual or double in its name is not acceptable as protection against a high hazard

Backpressure	Backsiphonage
	Low Hazard

Any backflow prevention device with the word vacuum in its name is not acceptable as protection against backpressure

	Backsiphonage
High Hazard	Low Hazard

You can remember the appropriate critical installation level for a vacuum breaker by using this chart. "A" comes before "P" alphabetically and "6" comes before "12" numerically.

Atmospheric	Pressure
1001	1020
6"	12"

Keep in mind that some terms are used interchangeably and imply the same condition.

Pollution = Low Hazard = Non-Toxic

Contaminant = High Hazard = Toxic

OHIO DEPARTMENT OF COMMERCE BACKFLOW PREVENTION MANUAL

BAROMETRIC LOOP

The Ohio Basic Building Code, Plumbing; Section 607, “Hot Water Supply System”, Sub-Section 607.3.2, “Backflow Prevention Device or Check Valve” specifies that:

“Where a backflow prevention device, check valve, or other device is installed on a water supply system utilizing storage water heating equipment such that thermal expansion causes an increase in pressure, a device for controlling pressure shall be installed.”

Thermal expansion of heated water will occur wherever potable water is heated in a closed system. Uncontrolled thermal expansion usually results in leaking faucets or burst washing machine supply hoses, but may result in the collapse of the vent pipe on gas-fired water heaters, or violently burst water heaters in extreme cases.

An expansion tank is the method in the plumbing code that is required and designed to absorb thermal expansion that will be created by the hot water heater, if the water user’s potable system is closed with a containment principle backflow prevention assembly, a check valve or a pressure reducing valve without an internal bypass.

The expansion tank must be installed in the cold water service piping on the supply side of the hot water heater prior to any control valves. The size of the expansion tank is based upon the size of the hot water heater and may be determined by referring to the manufacturer recommendations.

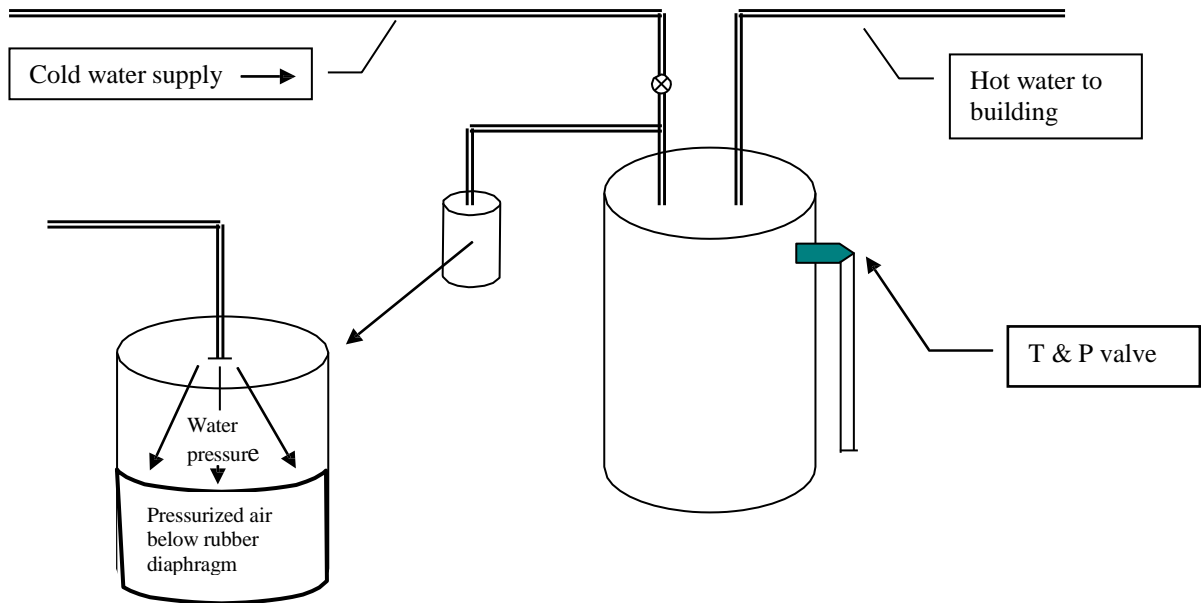

Figure 21

OHIO DEPARTMENT OF COMMERCE BACKFLOW PREVENTION MANUAL

BAROMETRIC LOOP

A barometric loop is a backflow prevention method that may be used as a protection only against backsiphonage. The critical installation level of a barometric loop is 35' above the flood level rim of the highest downstream fixture being supplied. Since atmospheric pressure will elevate water to a height of only 34 feet (14.7 psig X 2.31), then the 35' loop prevents a backsiphonage from occurring.

A barometric loop is not effective against backpressure but is effective against a low or high hazard and is usually installed on a single process line within the consumer's distribution system.

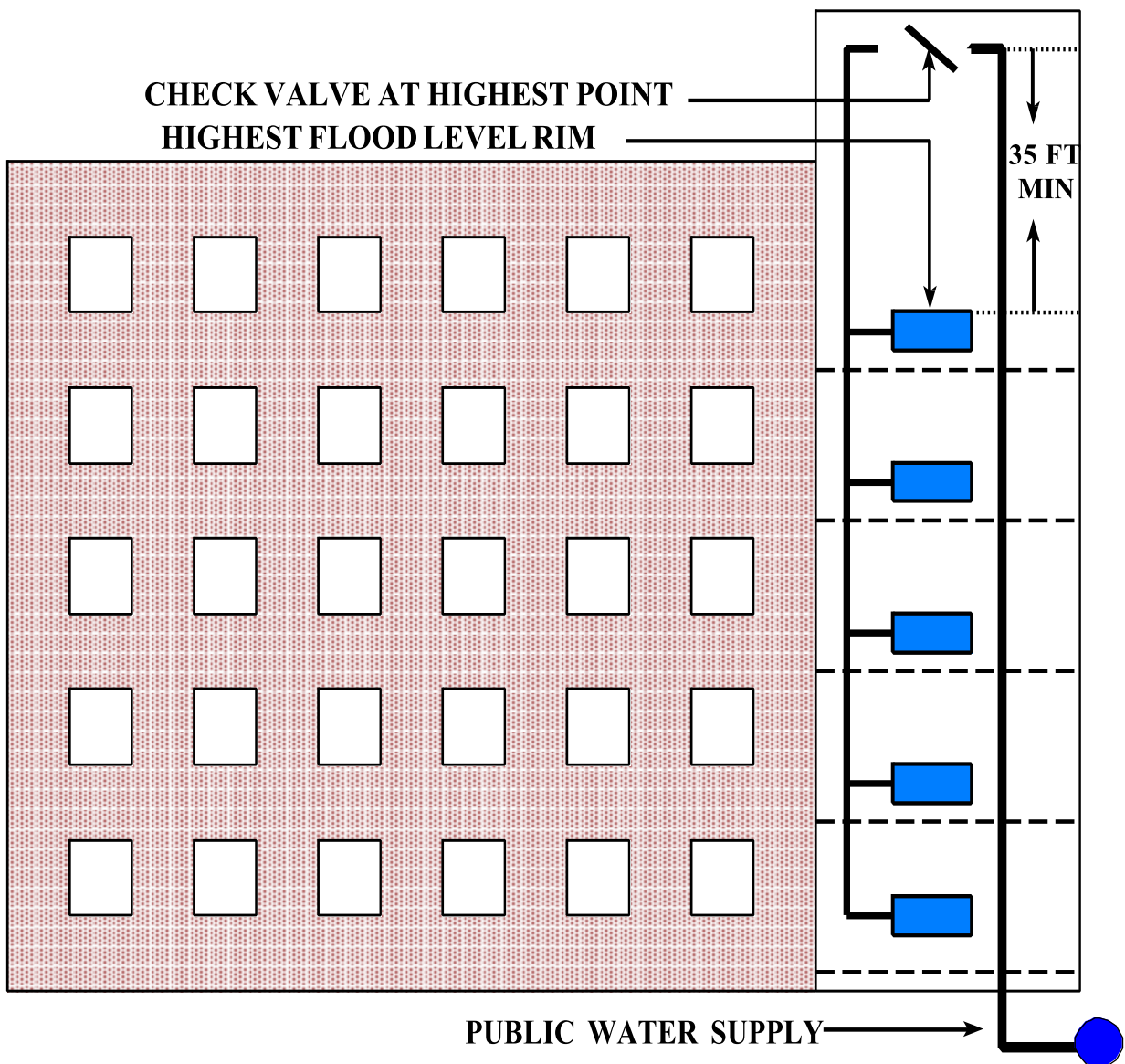

OHIO DEPARTMENT OF COMMERCE BACKFLOW PREVENTION MANUAL

AUXILIARY WATER SOURCES

An auxiliary water system is any water system on or available to the premises other than the public water system. These auxiliary water systems shall include used water or water from a source other than the public water system, such as wells, cisterns or open reservoirs that are equipped with pumps or other prime movers, including gravity.

An auxiliary water source may only be interconnected with the consumer's piping provided it meets the Ohio EPA requirements and is approved by the water supplier and the Ohio Environmental Protection Agency.

An interchangeable connector is the only approved means to interconnect a consumer's auxiliary water source with the piping connected to the public water system. The consumer's water piping and an auxiliary water source may be interconnected only in an industrial setting and provided it is approved by the Ohio EPA (this is the exception to the general rule that the Ohio EPA has no authority inside the building).

If the use of an interchangeable connector is approved, then an approved containment principle reduced pressure backflow preventer must be installed at the water meter and on the leg prior to the interchangeable connector that is supplying water from the consumer's water distribution system. See page 53 for drawings on installation requirements.

In a residential setting the public water service shall not be interconnected with an auxiliary water source under any condition.

It must be noted that any premises that has an auxiliary water source on or available to the premises must have a containment reduced pressure principle backflow prevention assembly installed at the water meter even though there is no intent to interconnect the two sources. This requirement is due to the potential for the two sources to be inadvertently interconnected in the future.

OHIO DEPARTMENT OF COMMERCE BACKFLOW PREVENTION MANUAL

INTERCHANGEABLE CONNECTOR

There are two types of interchangeable connectors.

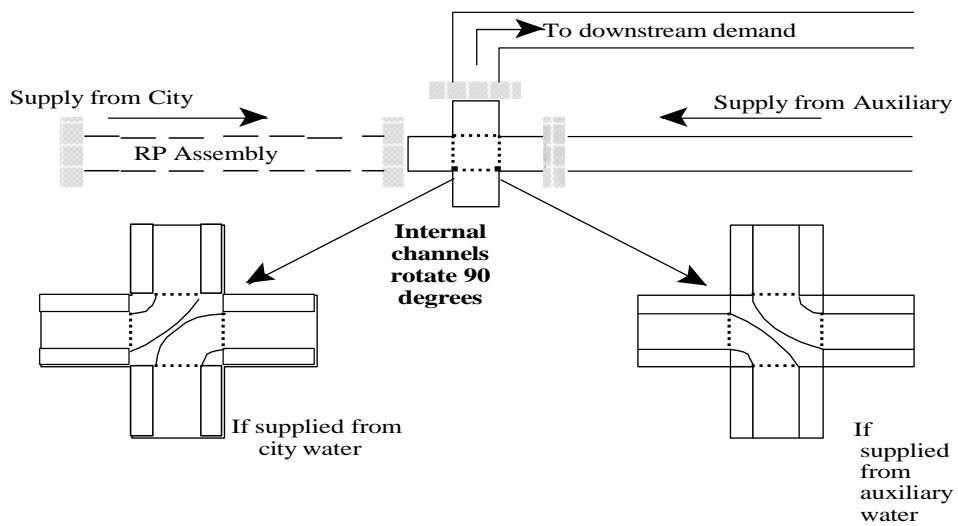
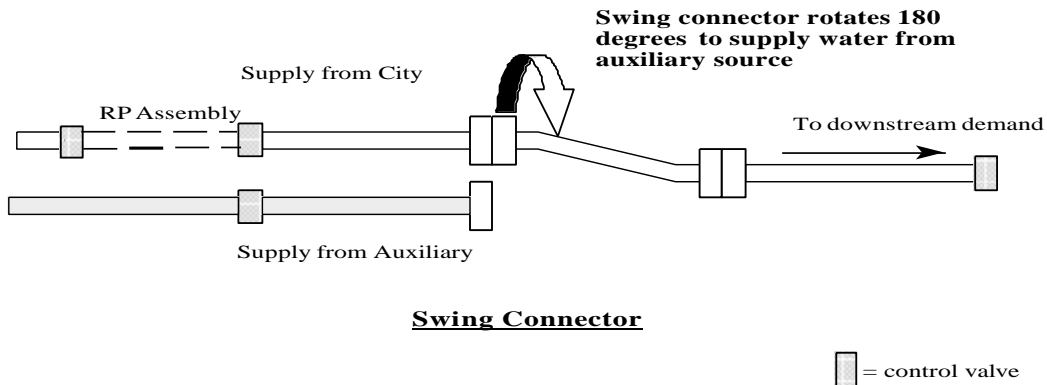

Four-Way Valve

The drain port on the four way valve shall not be installed in the vertical position

Diagrams from the Ohio EPA Manual

OHIO DEPARTMENT OF COMMERCE BACKFLOW PREVENTION MANUAL

LOW-SUCTION PRESSURE CUT-OFF CONTROLLER

The Ohio Environmental Protection Agency and the Ohio Department of Commerce require that a low-suction pressure cut-off controller must be installed on any domestic water booster pump that takes direct suction from the public water system. This applies to potable water pumps not intended for fire suppression.

A low-suction pressure cut-off controller (LPS) is intended to shut-off a booster pump, if the pressure on the suction-side of that booster pump drops to 10 psig. There is a thirty second delay after the pressure drops to 10 psig, and the LPS will shut-down the booster pump if the suction-side pressure remains at 10 psig for that entire thirty second period.

It is an electronic controller that senses the supply pressure to the booster pump via a piped connection at the suction-side of the booster pump. It is wired to the booster pump controller. If the pressure on the suction-side of the pump drops to 10 psig, there is a prescribed set of audible and visual indicators on the LPS controller indicating that a low-suction pressure condition exists.

Most booster pump manufacturers now include the low-suction cut-off controller as an integral part of the pump controller. The stand alone cut-off controller as shown in the illustration will be necessary only on a retrofit of an existing booster pump. These controllers must be tested at the time of installation and every twelve months thereafter.

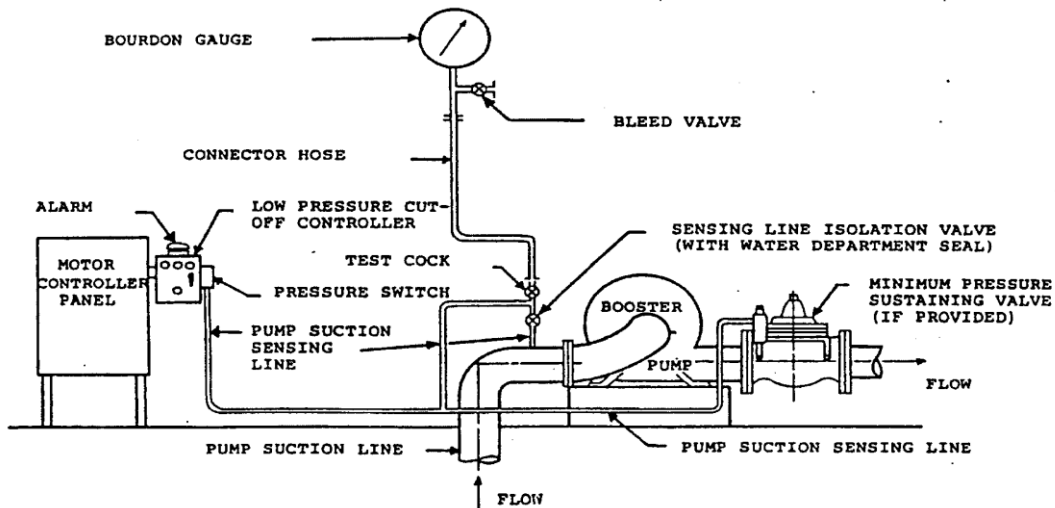

Illustration from Ohio EPA Manual

OHIO BASIC BUILDING CODE PLUMBING

SECTION 608

PROTECTION OF POTABLE WATER SUPPLY

608.1 General A potable water supply system shall be designed, installed and maintained in such a manner as to prevent contamination from non-potable liquids, solids or gases from being introduced into the potable water supply through cross-connections or any other piping connections to the system. Backflow preventer applications shall conform to Table 608.1, except as specifically stated in Sections 608.2 through 608.16.10.

608.2 Plumbing Fixtures The supply lines or fitting for every plumbing fixture shall be installed so as to prevent backflow. Plumbing fixture fittings shall provide backflow protection in accordance with ASME A112.18.1.

608.3 Devices, Appurtenances, Appliances and Apparatus All devices, appurtenances, appliances and apparatus intended to serve some special function, such as sterilization, distillation, processing, cooling, storage of ice or foods, and that connect to the water supply system, shall be provided with protection against backflow and contamination of the water supply system. Water pumps, water-powered sump pumps, filters, softeners, tanks and all other appliances and devices that handle or treat potable water shall be protected against contamination.

608.3.1 Special Equipment, Water Supply Protection The water supply for hospital fixtures shall be protected against backflow with a reduced pressure principle backflow preventer, an atmospheric or spill-proof vacuum breaker or an air-gap. Vacuum breakers for bedpan washer hoses shall not be located less than 5 (1524 mm) feet above the floor. Vacuum breakers for hose connections in health care or laboratory areas shall not be less than 6 (1829mm) feet above the floor.

608.4 Water Service Piping Water Service piping shall be protected in accordance with Sections 603.2 and 603.2.1.

608.5 Chemicals and Other Substances Chemicals and other substances that produce toxic conditions, taste, odor or discoloration in the potable water system, shall not be introduced into, or utilized in, such system.

608.6 Cross-Connection Control Cross-connections shall be prohibited, except where approved protective devices are installed.

608.6.1 Private Water Supplies Cross-connections between a private water supply and a potable public supply shall be prohibited.

608.7 Stop-and-Waste Valves Prohibited Potable water outlets and combination stop and waste valves shall not be installed underground or below grade. Freezeproof yard hydrants that drain the riser into the ground are considered to be stop and waste valves.

Exception: Freezeproof yard hydrants that drain the riser into the ground shall be permitted to be installed, provided that the potable water supply to such hydrants is protected upstream of the hydrants in accordance with Section 608 and the hydrants are permanently identified as nonpotable outlets by approved signage that reads as follows: "Caution, Nonpotable Water. Do Not Drink."

608.8 Identification of nonpotable water systems. Where nonpotable water systems are installed, the piping conveying the nonpotable water shall be identified either by color marking, metal tags or tape in accordance with Sections 608.8.1 through 608.8.2.3.

608.8.1 Signage required. Nonpotable water outlets, such as hose connections, open ended pipes and faucets, shall be identified with signage that reads as follows: “Nonpotable water is utilized for [application name]. CAUTION: NONPOTABLE WATER – DO NOT DRINK.” The words shall be legibly and indelibly printed on a tag or sign constructed of corrosion-resistant waterproof material or shall be indelibly printed on the fixture. The letters of the words shall be not less than 0.5 inch (12.7 mm) in height and in colors in contrast to the background on which they are applied. In addition to the required wordage, the pictograph shown in Figure 608.8.1 shall appear on the required signage.



**FIGURE 608.8.1
PICTOGRAPH—DO NOT DRINK**

608.8.2 Distribution pipe labeling and marking. Nonpotable distribution piping shall be purple in color and shall be embossed, or integrally stamped or marked, with the words: “CAUTION: NONPOTABLE WATER – DO NOT DRINK” or the piping shall be installed with a purple identification tape or wrap. Pipe identification shall include the contents of the piping system and an arrow indicating the direction of flow. Hazardous piping systems shall also contain information addressing the nature of the hazard. Pipe identification shall be repeated at intervals not exceeding 25 feet (7620 mm) and at each point where the piping passes through a wall, floor or roof. Lettering shall be readily observable within the room or space where the piping is located.

608.8.2.1 Color. The color of the pipe identification shall be discernable and consistent throughout the building. The color purple shall be used to identify reclaimed, rain and gray water distribution systems.

608.8.2.2 Lettering size. The size of the background color field and lettering shall comply with Table 608.8.2.2.

TABLE 608.8.2.2

SIZE OF PIPE IDENTIFICATION

PIPE DIAMETER (inches)	LENGTH OF BACKGROUND COLOR FIELD (inches)	SIZE OF LETTERS (inches)
¾ to 1-1/4	8	0.5
1-1/2 to 2	8	0.75
2-1/2 to 6	12	1.25
8 to 10	24	2.5
Over 10	32	3.5

For SI: 1 inch = 25.4 mm

608.8.2.3 Identification tape. Where used, identification tape shall be at least 3 inches (76 mm) wide and have white or black lettering on a purple field stating “CAUTION: NONPOTABLE WATER – DO NOT DRINK.” Identification tape shall be installed on top of nonpotable rainwater distribution pipes, fastened at least every 10 feet (3048 mm) to each pipe length and run continuously the entire length of the pipe.

608.9 Reutilization prohibited. Water utilized for the cooling of equipment or other processes shall not be returned to the potable water system. Such water shall be discharged into a drainage system through an air gap or shall be utilized for nonpotable purposes.

608.10 Reuse of piping. Piping that has been utilized for any purpose other than conveying potable water shall not be utilized for conveying potable water.

**TABLE 608.1
APPLICATION OF BACKFLOW PREVENTERS**

DEVICE	DEGREE OF HAZARD ^a	APPLICATION ^b	APPLICABLE STANDARDS
Backflow prevention assemblies			
Double check backflow preventer assembly and double check fire protection backflow assembly	Low hazard	Backsiphonage or backpressure Sizes 3/8" - 16"	ASSE 1015, AWWA C510, CSA B64.5, CSA B64.5.1
Double check detector fire protection backflow prevention assembly	Low hazard	Backsiphonage or backpressure Sizes 2" – 16"	ASSE 1048
Pressure vacuum breaker assembly	High or low hazard	Backsiphonage only Sizes ¼" - 2"	ASSE 1020, CSA B64.1.2
Reduced pressure principle backflow preventer and reduced pressure principle fire protection backflow preventer	High or low hazard	Backsiphonage or backpressure Sizes 3/8" – 16"	ASSE 1013, AWWA C511, CAN/CSA B64.4, CSA B64.4.1
Reduced pressure detector fire protection backflow prevention assemblies	High or low hazard	Backsiphonage or backpressure (Fire sprinkler systems)	ASSE 1047
Spill resistant vacuum breaker assembly	High or low hazard	Backsiphonage only Sizes ¼" - 2"	ASSE 1056

Backflow preventer plumbing devices			
Antisiphon-type fill valves for gravity water closet flush tanks	High hazard	Backsiphonage only	ASSE 1002, CSA B125.3
Backflow preventer for carbonated beverage machines	Low hazard	Backsiphonage or backpressure Sizes ¼" - 3/8"	ASSE 1022
Backflow preventer with intermediate atmospheric vents	Low hazard	Backsiphonage or backpressure Sizes ¼"-¾"	ASSE 1012, CAN/CSA B64.3
Dual-check-valve-type backflow preventer	Low hazard	Backsiphonage or backpressure Sizes ¼" 1"	ASSE 1024, CSA B64.6
Hose connection backflow preventer	High or low hazard	Low head backpressure, rated working pressure, backpressure or backsiphonage Sizes ½"-1"	ASSE 1052, CSA B64.2.1.1
Hose connection vacuum breaker	High or low hazard	Low head backpressure or backsiphonage Sizes ½"-1"	ASSE 1011, CAN/CSA B64.2, CSA B64.2.1
Lavatory faucet backflow preventer	High or low hazard	Low head backpressure and backsiphonage	ASSE 1035, CSA B64.7
Pipe-applied atmospheric-type vacuum breaker	High or low hazard	Backsiphonage only Sizes ¼" - 4"	ASSE 1001, CAN/CSA B64.1.1
Vacuum breaker wall hydrants, frost-resistant, automatic draining type	High or low hazard	Low head backpressure or backsiphonage Sizes ¾", 1"	ASSE 1019, CAN/CSA B64.2.2
Other means or methods			
Air gap	High or low hazard	Backsiphonage or backpressure	ASME A112.1.2
Air gap fittings for use with plumbing fixtures, appliances and appurtenances	High or low hazard	Backsiphonage or backpressure	ASME A112.1.3
Barometric loop	High or low hazard	Backsiphonage only	(See section 608.13.4)

For SI: 1inch = 25.4 mm

a. Low hazard-See Pollution (Section202) High hazard-See Contamination (Section202)

b. See Backpressure (Section202) See Backpressure, low head (Section202) See Backsiphonage (Section202)

608.11 Painting of water tanks. The interior surface of a potable water tank shall not be lined, painted or repaired with any material that changes the taste, odor, color or potability of the water supply when the tank is placed in, or returned to, service.

608.12 Pumps and other appliances. Water pumps, filters, softeners, tanks and other devices that handle or treat potable water shall be protected against contamination.

608.13 Backflow protection. Means of protection against backflow shall be provided in accordance with Sections 608.13.1 through 608.13.10.

608.13.1 Air gap. The minimum required air gap shall be measured vertically from the lowest end of a potable water outlet to the flood level rim of the fixture or receptacle into which such potable water outlet discharges. Air gaps shall comply with ASME A112.1.2 and air gap fittings shall comply with ASME A112.1.3.

608.13.2 Reduced pressure principle backflow prevention assemblies. Reduced pressure principle backflow prevention assemblies shall conform to ASSE 1013, AWWA C511, CSA B64.4 or CSA B64.4.1. Reduced pressure detector assembly backflow preventers shall conform to ASSE 1047. These devices shall be permitted to be installed where subject to continuous pressure conditions. The relief opening shall discharge by air gap and shall be prevented from being submerged.

608.13.3 Backflow preventer with intermediate atmospheric vent. Backflow preventers with intermediate atmospheric vents shall conform to ASSE 1012 or CSA B64.3. These devices shall be permitted to be installed where subject to continuous pressure conditions. The relief opening shall discharge by air gap and shall be prevented from being submerged.

608.13.4 Barometric loop. Barometric loops shall precede the point of connection and shall extend vertically to a height of 35 feet (10 668 mm). A barometric loop shall only be utilized as an atmospheric-type or pressure-type vacuum breaker.

608.13.5 Pressure vacuum breaker assemblies. Pressure vacuum breaker assemblies shall conform to ASSE 1020 or CSA B64.1.2. Spill-resistant vacuum breaker assemblies shall comply with ASSE 1056. These assemblies are designed for installation under continuous pressure conditions where the critical level is installed at the required height. Pressure vacuum breaker assemblies shall not be installed in locations where spillage could cause damage to the structure.

608.13.6 Atmospheric-type vacuum breakers. Pipe-applied atmospheric type vacuum breakers shall conform to ASSE 1001 or CSA B64.1.1. Hose connection vacuum breakers shall conform to ASME A112.21.3, ASSE 1011, ASSE 1019, ASSE 1035, ASSE 1052, CSA B64.2, CSA B64.2.1, CSA B64.2.1.1, CSA B64.2.2 or CSA B64.7. These devices shall operate under normal atmospheric pressure when the critical level is installed at the required height.

608.13.7 Double check backflow prevention assemblies. Double check backflow prevention assemblies shall conform to ASSE 1015, CSA B64.5, 4101:3-6-01 32 CSA B64.5.1 or AWWA C510. Double check detector fire protection backflow prevention assemblies shall conform to ASSE 1048. These assemblies shall be capable of operating under continuous pressure conditions.

608.13.8 Spill-resistant pressure vacuum breaker assemblies. Spill resistant pressure vacuum breaker assemblies shall conform to ASSE 1056 or CSA B64.1.3. These assemblies are designed for installation under continuous-pressure conditions where the critical level is installed at the required height.

608.13.9 Chemical dispenser backflow devices. Backflow devices for chemical dispensers shall comply with ASSE 1055 or shall be equipped with an air gap fitting.

608.13.10 Dual check backflow preventer. Dual check backflow preventers shall conform to

ASSE 1024 or CSA B64.6.

608.14 Location of backflow preventers. Access shall be provided to backflow preventers as specified by the manufacturer's instructions.

608.14.1 Outdoor enclosures for backflow prevention devices. Outdoor enclosures for backflow prevention devices shall comply with ASSE 1060.

608.14.2 Protection of backflow preventers. Backflow preventers shall not be located in areas subject to freezing except where they can be removed by means of unions or are protected from freezing by heat, insulation or both.

608.14.2.1 Relief port piping. The termination of the piping from the relief port or air gap fitting of a backflow preventer shall discharge to an approved indirect waste receptor or to the outdoors where it will not cause damage or create a nuisance.

608.15 Protection of potable water outlets. All potable water openings and outlets shall be protected against backflow in accordance with Section 608.15.1, 608.15.2, 608.15.3, 608.15.4, 608.15.4.1 or 608.15.4.2.

608.15.1 Protection by air gap. Openings and outlets shall be protected by an air gap between the opening and the fixture flood level rim as specified in Table 608.15.1. Openings and outlets equipped for hose connection shall be protected by means other than an air gap.

608.15.2 Protection by reduced pressure principle backflow prevention assembly. Openings and outlets shall be protected by a reduced pressure principle backflow prevention assembly or a reduced pressure principle fire protection backflow prevention assembly on potable water supplies.

608.15.3 Protection by a backflow preventer with intermediate atmospheric vent. Openings and outlets shall be protected by a backflow preventer with an intermediate atmospheric vent.

**TABLE 608.15.1
MINIMUM REQUIRED AIR GAPS**

FIXTURE	MINMUM AIR GAP	
	Away from a wall ^a (inches)	Close to a wall (inches)
Lavatories and other fixtures with effective openings not greater than 1/2 inch in diameter	1	1-1/2
Sinks, laundry trays, gooseneck back faucets and other fixtures with effective openings not greater than 3/4 inch in diameter	1-1/2	2-1/2
Over-rim bath fillers and other fixtures with effective openings not greater than 1 inch in diameter	2	3
Drinking water fountains, single orifice not greater than 7/16 inch in diameter or multiple orifices with a total area of 0.150 square inch (area of circle 7/16 inch in (diameter)	1	1-1/2
Effective openings greater than 1 inch	Two times the diameter of the effective opening	Three times the diameter of the effective opening

For SI: 1 inch = 25.4 mm, 1 square inch = 645 mm².

a. Applicable where walls or obstructions are spaced from the nearest inside-edge of the spout opening a distance greater than three times the diameter of the effective opening for a single wall, or a distance greater than four times the diameter of the effective opening for two intersecting walls.

608.15.4 Protection by a vacuum breaker. Openings and outlets shall be protected by atmospheric-type or pressure type vacuum breakers. The critical level of the vacuum breaker shall be set not less than 6 inches (152 mm) above the flood level rim of the fixture or device. All valves shall be set in accordance with Section 425.3.1. Vacuum breakers shall not be installed under exhaust hoods or similar locations that will contain toxic fumes or vapors. Pipe-applied vacuum breakers shall be installed not less than 6 inches (152 mm) above the flood level rim of the fixture, receptor or device served.

608.15.4.1 Deck-mounted and integral vacuum breakers. Approved deck-mounted or equipment mounted vacuum breakers and faucets with integral atmospheric vacuum breakers or spill-resistant vacuum breaker assemblies shall be installed in accordance with the manufacturer's instructions and the requirements for labeling with the critical level not less than 1 inch (25 mm) above the flood level rim.

608.15.4.2 Hose connections. Sillcocks, hose bibbs, wall hydrants and other openings with a hose connection shall be protected by an atmospheric-type or pressure-type vacuum breaker or a permanently attached hose connection vacuum breaker.

Exceptions:

1. This section shall not apply to water heater and boiler drain valves that are provided with hose connection threads and that are intended only for tank or vessel draining.
2. This section shall not apply to water supply valves intended for connection of clothes washing machines where backflow prevention is otherwise provided or is integral with the machine.

608.16 Connections to the potable water system. Connections to the potable water system shall

conform to Sections 608.16.1 through 608.16.10.

608.16.1 Beverage dispensers. The water supply connection to beverage dispensers shall be protected against backflow by a backflow preventer conforming to ASSE 1022 or by an air gap. The portion of the backflow preventer device downstream from the second check valve and the piping downstream therefrom shall not be affected by carbon dioxide gas.

608.16.2 Connections to boilers. The potable supply to the boiler shall be equipped with a backflow preventer with an intermediate atmospheric vent complying with ASSE 1012 or CSA B64.3. Where conditioning chemicals are introduced into the system, the potable water connection shall be protected by an air gap or a reduced pressure principle backflow preventer, complying with ASSE 1013, CSA B64.4 or AWWA C511. If the boiler feedwater, water treatment, or make-up water pipe is not provided with a high temperature check valve (rated at not less than 250 °F) near the boiler stop valve, then the temperature rating of the backflow preventer shall be not less than 250 °F.

608.16.3 Heat exchangers. Heat exchangers utilizing an essentially toxic transfer fluid shall be separated from the potable water by double-wall construction. An air gap open to the atmosphere shall be provided between the two walls. Heat exchangers utilizing an essentially nontoxic transfer fluid shall be permitted to be of single-wall construction.

608.16.4 Connections to automatic fire sprinkler systems and standpipe systems. The potable water supply to automatic fire sprinkler and standpipe systems shall be protected against backflow by a double check backflow prevention assembly, a double check fire protection backflow prevention assembly or a reduced pressure principle fire protection backflow prevention assembly.

Exceptions:

1. Where systems are installed as a portion of the water distribution system in accordance with the requirements of this code and are not provided with a fire department connection, isolation of the water supply system shall not be required.
2. Isolation of the water distribution system is not required for deluge, preaction or dry pipe systems.

608.16.4.1 Additives or nonpotable source. Where systems under continuous pressure contain chemical additives or antifreeze, or where systems are connected to a nonpotable secondary water supply, the potable water supply shall be protected against backflow by a reduced pressure principle backflow prevention assembly or a reduced pressure principle fire protection backflow prevention assembly. Where chemical additives or antifreeze are added to only a portion of an automatic fire sprinkler or standpipe system, the reduced pressure principle backflow prevention assembly or the reduced pressure principle fire protection backflow prevention assembly shall be permitted to be located so as to isolate that portion of the system. Where systems are not under continuous pressure, the potable water supply shall be protected against backflow by an air gap or an atmospheric vacuum breaker conforming to ASSE 1001 or CSA B64.1.1.

608.16.5 Connections to lawn irrigation systems. The potable water supply to lawn irrigation systems shall be protected against backflow by an atmospheric vacuum breaker, a pressure vacuum

breaker assembly or a reduced pressure principle backflow prevention assembly. Valves shall not be installed downstream from an atmospheric vacuum breaker. Where chemicals are introduced into the system, the potable water supply shall be protected against backflow by a reduced pressure principle backflow prevention assembly.

608.16.6 Connections subject to backpressure. Where a potable water connection is made to a nonpotable line, fixture, tank, vat, pump or other equipment subject to high-hazard backpressure, the potable water connection shall be protected by a reduced pressure principle backflow prevention assembly.

608.16.7 Chemical dispensers. Where chemical dispensers connect to the potable water distribution system, the water supply system shall be protected against backflow in accordance with Section 608.13.1, 608.13.2, 608.13.5, 608.13.6, 608.13.8 or 608.13.9.

608.16.8 Portable cleaning equipment. Where the portable cleaning equipment connects to the water distribution system, the water supply system shall be protected against backflow in accordance with Section 608.13.1, 608.13.2, 608.13.3, 608.13.7 or 608.13.8.

608.16.9 Dental pump equipment. Where dental pumping equipment connects to the water distribution system, the water supply system shall be protected against backflow in accordance with Section 608.13.1, 608.13.2, 608.13.5, 608.13.6 or 608.13.8.

608.16.10 Coffee machines and noncarbonated beverage dispensers. The water supply connection to coffee machines and noncarbonated beverage dispensers shall be protected against backflow by a backflow preventer conforming to ASSE 1022 or by an air gap.

608.17 Protection of individual water supplies. An individual water supply, otherwise known as a private water system, shall be located and constructed so as to be safeguarded against contamination in accordance with the rules of the “Ohio Department of Health” set forth in Chapter 3701-28 of the Administrative Code, “Private Water Systems.”

FOR THESE SPECIFIC PLUMBING COMPONENTS

WATER POWERED BACKUP SUMP PUMPS

This cross connection shall be considered a high hazard connection and shall be protected by a backflow device or method that would provide high hazard protection against backsiphonage by the proper installation of a device providing such protection. These devices shall be one of the following Air gap, Reduced pressure principle backflow preventer, Pressure-type vacuum breaker, Atmospheric-type vacuum breaker, Spillproof vacuum breaker. For additional information refer to the Ohio Plumbing Code sections 608.13.1, 608.13.2, 608.13.5, 608.13.6 or 608.13.8. The Water purveyor may require containment protection at the service entrance.

POST TYPE BURY LAWN HYDRANTS

This cross connection shall be considered a high hazard connection and shall be protected by a backflow device or method that would provide high hazard protection against backsiphonage by the proper installation of a reduced pressure principle backflow preventer on the supply side of the hydrant. For additional information refer to the Ohio Plumbing Code section 608.13.2. The outlet at the hydrant shall be labeled in an appropriate manner indicating that it is non potable/non drinking water. The Water purveyor may require containment protection at the service entrance.

PIPING SYSTEMS CONTAINING ETHYLENE GLYCOL

These systems are prohibited to be directly connection to a public water system and domestic water systems. They shall be provided with an approved air gap separation.

WATER LUBRICATED/WATER SEAL SEWAGE PUMPS

These systems are prohibited to be direct connection to a public water system and domestic water systems. They shall be provided with an approved air gap separation. To supply water to these pumps from a public water system it shall be through a secondary pump system that provides the water to a storage tank by air gap from which the pump system draws its water for pressurization to these types of pumps.

CHAPTER 7 –OHIO EPA RULES & REGULATIONS

OHIO ADMINISTRATIVE CODE

The following material is from the Ohio Administrative Code, and represents the regulations adopted by the Ohio Environmental Protection Agency on October 9, 1980. They replace and are essentially the same as Regulation HE-34 that was adopted by the Public Health Council of the Ohio Department of Health on April 15, 1972.

The local water supplier is responsible for and authorized to enforce these regulations, pertaining to containment principle protection, in his/her water distribution system.

The Ohio Environmental Protection Agency has published a Manual of Backflow Prevention and Cross-Connection Control which contains this Administrative Code and all of their rules, regulations, policies, guidelines and illustrations.

3745-95-02 Backflow prevention and cross-connections

- (A) No person shall install or maintain a water service connection to any premises where actual or potential cross-connections to a public water system or a consumer's water system may exist unless such actual or potential cross-connections are abated or controlled to the satisfaction of the supplier of water.
- (B) No person shall install or maintain a connection between a public water system or consumer's water system and an auxiliary water system may enter a public water system or consumer's water system unless the auxiliary water system, the method of connection and use of such system have been approved by the supplier of water and by the director as required by Section 6109.13 of the Revised Code.
- (C) A public water system shall develop and implement a backflow prevention and cross-connection control program consistent with this chapter.

3745-95-03 Surveys and Investigations

- (A) The supplier of water shall conduct or cause to be conducted an initial assessment and periodic surveys and investigations, of water use practices within a consumer's premises to determine whether there are actual or potential cross-connections to the consumer's water system through which pollutants or contaminants could backflow into the public water system or determine where in the judgement of the supplier of water, a polluttional system, health or severe health hazard to the public water system exists.

To meet this requirement, the supplier of water shall conduct or cause to be conducted an on-site investigation of all premises at least every five years to identify changes in water use practices at the consumer's property so that new or increased hazards to the water supply are identified and mitigated.

1. In lieu of conducting on-site investigation of all premises every five years, the supplier

of water can document, in writing, an alternate on-going, methodology to identify changes in the water use practices that may represent a new or increased hazards to the water supply. An on-site investigation is required when a potential new or increased hazard is suspected to confirm the degree of risk, and how it will be addressed. Information obtained through a water use survey questionnaire or in coordination with the local building, zoning, health, fire protection and other licensing agencies may be used as an indicator of when an on-site investigation should be conducted. Other triggers, such as a request to the supplier of water for a new or additional service line, or an additional or larger water meter should warrant an on-site investigation.

2. In lieu of conducting an on-site investigation of each residential premise, the supplier of water may institute an on-going educational campaign to inform consumers of common backflow hazards created during residential water use and provide a reporting mechanism for suspected cross-connections. An education campaign may use local media or advertising resources, but must also include delivered, either electronically or hard copy, to each residential service connection at least annually.

(B) The supplier of water, or his authorized representative, shall have the right to enter premises served by the public water system at all reasonable times for the purpose of making surveys and investigations of water use practices within the premises.

(C) On request by the supplier of water, or his authorized representative, the consumer shall furnish the supplier, or the supplier's authorized representative, information on water use practices within the consumer's premises.

(D) Paragraph (A) of this rule does not relieve the consumer of the responsibility for conducting, or causing to be conducted, periodic surveys of water use practices on his premises to determine whether there are actual or potential cross-connections in the consumer's water system through which pollutants or contaminants could backflow into a public water system or a potable consumer's water system.

3745-95-04 Where Protection is Required

(A) An approved backflow prevention device shall be installed on each service line to a consumer's water system serving premises, where in the judgement of the supplier of water or the director, a pollution, system, health or severe health hazard to the public water exists.

(B) An approved backflow prevention device shall be installed on each service line to a consumer's water system serving premises where any of the following conditions exist:

(1) Premises having an auxiliary water system, unless such auxiliary system is accepted as an additional source by the supplier of water and the source is approved by the director;

(2) Premises on which any substance is handled in such a fashion as to create an actual or potential hazard to a public water system. This shall include premises having sources or systems containing process fluids;

(3) Premises having internal cross-connections that, in the judgment of the supplier of

water, are not correctable, or intricate plumbing arrangements which make it impractical to determine whether or not cross-connections exist;

- (4) Premises where, because of security restrictions or other prohibitions or restrictions, it is impossible or impractical to make a complete cross-connection survey;
- (5) Premises having a repeated history of cross-connections being established or re-established;
- (6) Others specified by the director.

(C) The following requirements apply to premises that have an auxiliary water system on the real property that is owned or under control of the consumer and adjacent to the premises”.

- 1) A physical separation shall be maintained between the public water system or a consumers’ water system and the auxiliary water system as required by paragraph (B) of rule 3745-95-02 of the Administrative Code: and
- 2) An approved backflow prevention device shall be installed on each service connection serving the consumers’ water system, unless the supplier of water does all of the following:
 - a. Determines, on a case-by-case basis, that the installation of an approved backflow prevention device is not required in consideration of factors including, but not limited to, the past history of cross connections being established or re-established on the premises, the ease or difficulty of connecting the auxiliary water system with the public water system on the premises, the presence or absence of contaminants on the property or other risk factors;
 - b. Requires the consumer to sign an agreement which specifies the penalties, including those set forth in rule 3745-95-08 of the Administrative Code, for creating a connection between the public water system and the auxiliary water system:
 - c. Conducts or causes to be conducted an inspection at least every twelve months to certify that no connection or means of connection has been created between the public water system and the auxiliary water system;
 - d. Maintains an inventory of each consumers’ premises, where an auxiliary water system is on or available to the premises, or on the real property adjacent to the premises; and
 - e. Develops and implements an education program to inform all consumers served by the public water system about the dangers of cross connections and how to eliminate cross connections.

- (D) An approved backflow prevention device shall be installed on each service line to a consumer's water system serving, but not necessarily limited to, the following types of facilities unless the director determines that no severe health, health, systems or pollutional hazard to the public water system exists:
- (1) Hospitals, mortuaries, clinics, nursing homes;
 - (2) Laboratories;
 - (3) Piers, docks, waterfront facilities;
 - (4) Sewage treatment plants, sewage pumping stations, or storm water pumping stations;
 - (5) Food or beverage processing plants;
 - (6) Chemical plants;
 - (7) Metal plating industries;
 - (8) Petroleum processing or storage plants;
 - (9) Radioactive material processing plants or nuclear reactors;
 - (10) Car washes; and
 - (11) Others specified by the director.
- (E) An approved backflow prevention device shall be installed at any point of connection that is approved in accordance with paragraph (B) of rule 3745-95-02 of the Administrative Code between a public water system or a consumer's water system and an auxiliary water system, unless such auxiliary system is acceptable as an additional source by the supplier of water and the source is approved by the director.

Chapter 3745-95-05 Type of Protection Required

- (A) The type of protection required under paragraph (A), (B), (C) and (D) of Rule 3745- 95-04 of the Ohio Administrative Code shall depend on the degree of hazard which exists as follows:
- (1) An approved air-gap separation shall be installed where a public water system can be contaminated with substances that could cause a severe health hazard;
 - (2) An approved air-gap separation, or an approved reduced pressure principle backflow prevention assembly, or an approved reduced pressure detector check assembly shall be installed where a public water system may be contaminated with any substance that could cause a system or health hazard;
 - (3) An approved air-gap separation, or an approved reduced pressure principle backflow prevention assembly, or an approved reduced pressure detector check assembly, an approved double check valve assembly, or an approved double check detector check valve assembly shall be installed where a public water system may be contaminated with substances that could cause a pollution hazard.

- (B) The type of protection required under paragraph (E) of Rule 3745-95-04 of the Ohio Administrative Code shall be an approved air-gap separation or an approved interchangeable connection. A removable spool piece connection is not an acceptable method.
- (C) Where an auxiliary water system is used as a secondary source of water for a fire protection system, the provisions of paragraph (B) of this Rule for an approved air-gap separation or an approved interchangeable connection may be waived by the director provided the following conditions exist:
- (1) At premises where the auxiliary water system may be contaminated with substances that could cause a system, health or severe health hazard, a public water system or a consumer's water system shall be protected against backflow by installation of an approved reduced pressure principle backflow prevention device or an approved reduced pressure principle detector check assembly;
 - (2) At all other premises, a public water system or a consumer's water system shall be protected against backflow by installation of an approved reduced pressure principle backflow prevention assembly, an approved reduced pressure principle detector check assembly, an approved double check valve assembly, or an approved double check detector assembly;
 - (3) A public water system or a consumer's water system shall be the primary source of water for the fire protection system;
 - (4) The fire protection system shall be normally filled with water from a public water system or a consumer's water system;
 - (5) The water in the fire protection system shall be used for fire protection only, with no other use of water from the fire protection system downstream from the approved backflow prevention device.
- (D) An exception to the requirement in paragraph (A)(2) of this rule may be applied when mitigating the health hazard associated with a water-only, residential type irrigation system that is not subject to backpressure and is not equipped with pumps or other prime movers which can create backpressure to the public or consumer's water system. In this instance an approved pressure vacuum breaker can be used to isolate the service line to the irrigation system in lieu of installing a containment assembly at the service connection. The same maintenance and testing requirements as outlined in rule for containment assemblies apply. This exception does not apply if an additive is used within the irrigation system. The supplier of water may determine other hazards exist that warrant additional containment protection at the service connection.

3745-95-06 Backflow Prevention Devices

- (A) Any containment principle backflow prevention device required by rules 3745-95-04 and 3745-95-05 of the Administrative Code shall be of a model or construction approved by the supplier of water and conform to at least one of the following standards.
- (1) For air-gap separation: the specific edition of the American National Standards Institute (ANSI) and the American society of mechanical engineers (ASME) standard as referenced in rule 4101:3-13-01 of the Administrative Code;
 - (2) For reduced pressure principle backflow prevention assemblies: the specific edition of the ANSI and the American Water Works Association (AWWA) standard, or the American Society of Sanitary Engineering (ASSE) standard, or the Canadian Standards Association (CSA) standard as referenced in rule 4101:3-13-01 of the Administrative Code; or the Foundation for Cross Connection Control and Hydraulic Research of Southern California Specifications of backflow assemblies for reduced pressure principle assemblies - Tenth Edition (2009)
 - (3) For double check valve assemblies: the specific edition of the ANSI and the AWWA standard, or the ASSE standard, or the CSA standard as referenced in rule 4101:3-13-01 of the Administrative Code; or the Foundation for Cross Connection Control and Hydraulic Research of Southern California specifications of backflow assemblies for double check valve – tenth edition (2009).
 - (4) For reduced pressure principle-detector assemblies: the specific edition of the ANSI and the ASSE standard, or the CSA standard as referenced in rule 4101:3-13-01 of the Administrative Code; or the Foundation for Cross Connection Control and Hydraulic Research of Southern California specifications of backflow assemblies for reduced pressure principle-detector assemblies – tenth edition (2009).
 - (5) For double check-detector check valve assemblies: the specific edition of the ANSI and the ASSE standard, or the CSA standard as referenced in rule 4101:3-13-01 of the Administrative Code; or the Foundation for Cross Connection Control and Hydraulic Research of Southern California specifications of backflow assemblies for double check-detector assemblies – tenth edition (2009).
 - (6) For pressure vacuum breakers: the ANSI and the ASSE standard, or the CSA standard as referenced in rule 4101:3-13-01 of the Administrative Code;
- (B) Any containment principle backflow preventer required by Rules 3745-95-04 and 3745-95-05 of the Ohio Administrative Code shall be installed at a location and in a manner approved by the supplier of water and at the expense of the water consumer. In addition, any backflow prevention device required by paragraphs (B) and (C) of Rule 3745-95-05 of the Ohio Administrative Code shall be installed in a location and in a manner approved by the director as required by Section 6109.13 of the Ohio Revised Code.

- (C) It shall be the duty of the water consumer to maintain any containment principle backflow preventer required by rules 3745-95-04 and 3745-95-05 of the Ohio Administrative Code in working order and in continuous operation.
- (1) The supplier of water shall retain authority over any containment principle backflow preventer required by rules 3745-95 and 3745-95-05 of the Ohio Administrative Code
 - (2) It shall be the duty of the supplier of water to see that the tests and inspections required under this paragraph are made.
 - (3) The consumer shall on any premises on which any containment principle backflow preventer required by rules 3745-95-04 and 3745-95-05 of the Ohio Administrative Code are installed, to have thorough inspections and operational tests made of the backflow preventers at the time of the installation or repair, and as may reasonably required by the supplier of water or the director, but in all cases at least once every twelve months. These inspections and tests shall be at the expense of the water consumer and shall be performed by the supplier of water or a person approved by the supplier as qualified to inspect and rest backflow preventers.
 - (4) These devices shall be repaired, overhauled, or replaced at the expense of the consumer whenever they are found to be defective.
 - (5) Records of such inspections, tests, repairs, and overhaul shall be kept by the consumer and made available to the supplier of water.
 - (6) The supplier of water shall maintain a paper or electric record of inventory of survey investigation and containment principle backflow preventer installation reports. Records of inspections, tests, repairs and overhauls related to the containment principle backflow preventer required by rules 3745-95-04 and 3745-95-05 of the Administrative Code shall be maintained by the supplier of water for a minimum of five years.
- (D) The supplier of water shall inspect or cause to be inspected all installations where an approved connection exists between auxiliary water system and a consumer's water system at least once every twelve months and shall maintain an inventory of all such installations and inspection records. Such inventories and inspection records shall be made available during sanitary surveys and at other reasonable times. Paper or electronic records shall be maintained by the supplier of water for a minimum of five years.
- (E) Containment principle backflow preventers approved by the supplier of water and conforming to prior or subsequent editions of the standards cited in paragraph (A) of this rule, and which are properly maintained in accordance with paragraph (C) of this rule, shall be excluded from the requirements of paragraphs (A) and (B) of this rule if the supplier of water and the director are assured that the backflow preventer will satisfactorily protect the public water system.

3745-95-07 Booster Pumps

- (A) No person shall install or maintain a water service connection where a booster pump has been installed, unless an approved method is in place and is operational to maintain a minimum suction pressure as prescribed as presented in the following:
- (1) For booster pumps not intended to be used for fire suppression, no person shall install or maintain a water service connection to any premises where a booster pump has been installed on the service line to or within such premises, unless such booster pump is equipped with a low-suction pressure cut-off controller designed to shut off the booster pump when the pressure in the service line on the suction side of the pump drops to ten pounds per square inch gauge or less.
 - (2) For booster pumps used for fire suppression also referred to as fire pumps, installed after August 8, 2008, no person shall install or maintain a water service connection to any premises where a fire pump has been installed on the service line to or within such premises, unless the pump is equipped with one of the following:
 - (a) A low suction throttling valve which is a pilot-operated valve installed in the discharge piping that maintains positive pressure in the suction piping, while monitoring pressure in the suction piping through a sensing line. The valve must throttle the discharge of the pump when necessary so that suction pressure will not be reduced below ten pounds per square inch gauge while the pump is operating.
 - (b) A variable speed suction limiting control is a speed control system used to maintain a minimum positive suction pressure at the pump inlet by reducing the pump driver speed while monitoring pressure in the suction piping through a sensing line. It will be set so that the suction pressure will not be reduced below ten pounds per square inch while the pump is operating.
 - (3) For booster pumps used for fire suppression also referred to as fire pumps, installed prior to August 8, 2008, which are equipped with a low pressure cut-off as defined in paragraph (A)(1) of this rule are not required to modify the installation solely for the purpose of meeting the new methods accepted after this date, under paragraph (B)(1) of this rule.
- (B) It shall be the duty of the water consumer to maintain the low-suction pressure cut-off device, the low suction throttling valve, or the variable speed suction limiting control in proper working order and to certify to the supplier of water, at least once every twelve months that the minimum suction pressure sustaining method is operable and maintained in continuous operation.
- (C) The supplier of water must maintain electronic or paper records of inventory of booster pump installations. Electronic or paper records certifying operation must be retained for a period of five years.
- (D) The provision of this rule shall be followed notwithstanding inconsistent provisions in the Great Lakes-Upper Mississippi river broad of the state and provincial public health and environmental

managers' or "Recommended Standards for Water Works" (2012)

3745-95-08 Violations

- (A) The supplier of water shall deny or discontinue, after reasonable notice to the occupant thereof, the water service to any premises wherein any backflow prevention device required by this Chapter is not installed, tested, and maintained in a manner acceptable to the supplier of water, or if it is found that the backflow prevention device has been removed or bypassed, or if an unprotected cross-connection exists on the premises, or if a low-suction pressure cut-off required by rule 3745-95-07 of the Administrative Code is not maintained in working order, or if the supplier of water or the director or the authorized representative of either, is denied entry to determine compliance with these Rules of the Ohio Administrative Code.
- (B) Water service to such premises shall not be restored until the consumer has corrected or eliminated such conditions or defects in conformance with this chapter of the Administrative Code, and to the satisfaction of the supplier of water.

APPROVED YARD HYDRANTS

Chapter 3745-95-09 Requirements for yard hydrants

- (A) Yard hydrants with weep holes.
 - (1) Yard hydrants with weep holes used for human consumption installed on a public water system are prohibited unless the weep holes are sealed.
 - (2) Yard hydrants with weep holes not used for human consumption installed on a public water system, and those installed on a consumer's water system, shall have an appropriate backflow prevention assembly on the service line to protect the public water system. Yard hydrants with weep holes installed on public water systems shall be clearly labeled as "non-potable" or "not for human consumption."
- (3) Sanitary yard hydrants that do not have weep holes, such as those that meet the requirements of the "American Society of Sanitary Engineers (ASSE) standard 1057, Performance Requirements for Freeze Resistant Yard Hydrants with Backflow Protection" (2001), are not prohibited provided:
 - (1) The device is acceptable to the public water system to which it will be connected:
and
 - (2) Any other applicable backflow prevention and cross-connection control requirements of this chapter are met.

OHIO DEPARTMENT OF COMMERCE BACKFLOW PREVENTION MANUAL

POLICY ON THE USE OF ANTIFREEZE

The Ohio Environmental Protection Agency and the Ohio Department of Commerce agree that the use of ethylene glycol antifreeze in a consumer's water system poses a severe high/severe health hazard.

These regulatory agencies require that an approved air-gap separation shall be installed at the water supply make-up line to any piping system that contains ethylene glycol based antifreeze.

If an approved antifreeze is used (see 1 and 2 below), then an approved reduced pressure principle backflow prevention device may be installed as protection on the water supply make-up line.

The following information is provided as general information and to assist in the protection of a public water system when an antifreeze solution is required to prevent freezing of fire protection systems.

1. Antifreeze solutions can consist of either pure glycerin solution, provided the glycerin solution is of 96.5 per cent United States pharmacopoeia grade, or of food- grade propylene glycol base.
2. Propylene glycol plus dipotassium phosphate is acceptable for use as an antifreeze solution. The propylene glycol is the antifreeze component and the dipotassium phosphate functions as a bacterial inhibitor.

An approved double check valve assembly (ASSE 1015) or an approved double check detector check assembly (ASSE 1048) must be installed at the service connection to a fire protection system that contains no additives

An approved reduced pressure principle backflow preventer (ASSE 1013) or an approved reduced pressure principle detector check assembly (ASSE 1047) must be installed at the service connection to a fire protection system that contains any additive.

If a fire protection system contains ethylene glycol antifreeze then an approved air-gap separation is required as backflow protection, but the ethylene glycol may be replaced with propylene glycol and an ASSE 1013 or 1047 is acceptable as protection.

OHIO DEPARTMENT OF COMMERCE BACKFLOW PREVENTION MANUAL

CHECK LIST FOR TESTING

ALL BACKFLOW ASSEMBLIES SHALL BE TESTED ON SITE WHILE INSTALLED IN THE PIPING SYSTEM AND SHALL NOT BE REMOVED FOR TESTING PURPOSES

When you test a backflow prevention assembly, you are certifying that a device is operating properly and that the readings that you indicate on the test sheet are accurate and true.

The following checklist is intended to assist you in preparing to perform a test:

- ✓ check that you have the work order for the test location address
- ✓ check that your gauge is accurately calibrated
- ✓ check that you have the appropriate test form

Upon arrival at the premises, the first thing that you should do is contact the owner or maintenance man and remind him that you will have to turn the water off to perform the test.

The following checklist is intended to provide direction as you approach the device:

- ✓ check the manufacturer, size and serial number on the device to ensure that you are at the right device
- ✓ check that all four test cocks are in place and accessible
- ✓ check that no connections have been made prior to the device
- ✓ check that a bypass has not been installed around the device
- ✓ check for signs of leakage on the floor if you are testing a reduced pressure principle backflow preventer

The first thing that you must do before beginning the test is to flush the test cocks. This removes any debris that may have accumulated in the test cock so that it does not enter the test gauge and damage the internal components.

When flushing the test cocks on a testing a reduced pressure assembly, you should use the following procedure to ensure that you do not cause the differential relief valve to open prior to your test.

- ✓ Slightly open test cock number 4 and let the water run
- ✓ Open and then close test cock number 2
- ✓ Open and then close test cock number 3
- ✓ Close test cock number 4

OHIO DEPARTMENT OF COMMERCE BACKFLOW PREVENTION MANUAL

THREE-VALVE ANALOG TEST GAUGE

To ensure the continued satisfactory operation of backflow prevention devices, the devices must be periodically inspected and tested by individuals who are approved by the supplier of water in the case of containment protection and by the Ohio DOC in the case of isolation protection.

All backflow preventers are equipped with test cocks and must be tested before being put into service and at least every twelve months thereafter.

If a device has been replaced or if the supply line piping is altered or changed, the device shall be tested before being returned to service.

A device shall be tested after any routine maintenance, such as cleaning or internal inspection. If a device is repaired or overhauled, it shall be tested before returning to service.

When testing an assembly, make sure that the high-pressure, low-pressure and vent hoses are connected to the proper test cocks. To avoid damage to the test gauge, open the test cocks slowly when bleeding air through the vent hose.

The gauge most commonly used to test a backflow prevention device is a pressure differential gauge. This gauge compares the difference between two pressures and indicates the difference between the two pressures. The gauge indicates pressure in pounds and two tenths of a pound as pounds per square inch differential or psid.

This illustration is intended to familiarize you with the components of the three-valve test gauge for your use in using the test procedures on pages 78 to 85.

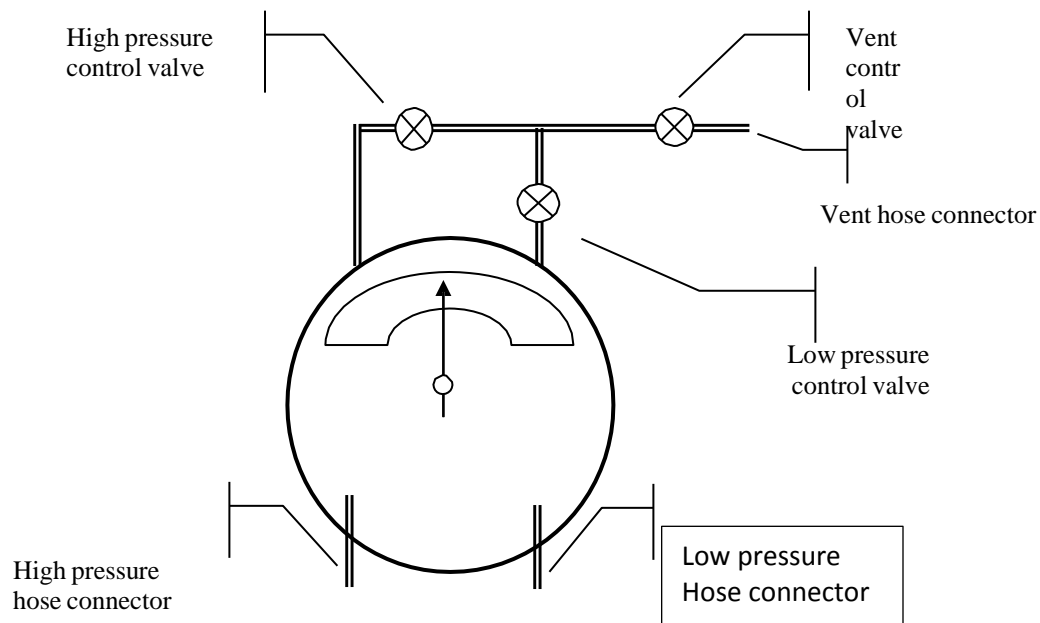

Figure 26

**OHIO DEPARTMENT OF COMMERCE
FIELD TEST PROCEDURE USING THREE VALVE GAUGE**

ASSE 1013 REDUCED PRESSURE PRINCIPLE ASSEMBLY

SETUP

- a. Install hose adapters and flush test cocks #2, #3, #4
- b. Close all control valves on the test gauge
- c. Close shut-off valve #2

TEST 1: Purpose: To test Check Valve #1
 Requirement: Check Valve #1 must indicate a pressure differential equal to or greater than 5 psid to continue the test

PROCEDURE

- a. Connect the high pressure hose to test cock #2
- b. Connect the low pressure hose to test cock #3
- c. Open test cock #3
- d. Open test cock #2
- e. Open the vent control valve on the gauge
- f. Open the high control valve to bleed any air from the hose and gauge
- g. Close the high control valve
- h. Open the low control valve to bleed any air from the hose and gauge
- i. Close the low control valve
- j. Observe the gage to verify that Check Valve #1 is creating a minimum pressure differential equal to or greater than 5 psid in order to continue the test. Record the reading on the test form

TEST 2: Purpose: To test the Pressure Differential Relief Valve
 Requirement: The Relief Valve must maintain a pressure differential of at least 2 psid between the Relief Valve Zone and the supply pressure

PROCEDURE

- a. Close the vent control valve
- b. Open the high control valve
- c. Slightly open the low control valve to slowly increase the water pressure in the intermediate pressure zone, the gauge needle should begin to drop toward zero and observe when water first begins to discharge from the relief port.
- d. Observe the gauge reading at which this discharge is first occurring and record the psid reading shown on the gauge.
- e. Record the Relief Valve as passed if water discharged at 2 psid or greater
- f. Compare the gauge reading obtained for Check Valve #1 and the Relief Valve. The Check Valve #1 psid must be 3psi or greater than the Relief Valve psid for Check Valve #1 to pass.
- g. Close the high and low control valves

CONTINUE TO TEST 3 & 4

OHIO DEPARTMENT OF COMMERCE FIELD TEST PROCEDURE USING THREE VALVE GAUGE

ASSE 1013 REDUCED PRESSURE PRINCIPLE ASSEMBLY

TEST 3: Purpose: To test Check Valve #2
Requirement: Check Valve #2 must hold tightly against backpressure

PROCEDURE

- a. Open the vent control valve
- b. Open the high control valve to bleed any air from the hose and gauge
- c. Close the high control valve
- d. Open the low control valve to bleed any air from the hose and gauge
- e. Close the low control valve
- f. Connect the vent hose to test cock #4
- g. Open the high control valve
- h. While observing the gauge, open test cock #4.

The gauge needle may drop slightly then should remain static if Check Valve #2 is holding tightly. If the gauge needle does not remain static and continues to drop downward and the relief valve starts to discharge water, then check valve #2 is leaking.

- i. Record Check Valve #2 as either pass or fail on the test form
-

TEST 4: Purpose: To test Shut-Off Valve #2
Requirement: Shut-Off Valve #2 must be drip-tight in order to obtain accurate test readings

PROCEDURE

- a. While observing the gauge, close test cock #2
The gauge needle may drop slightly then should remain static if Shut-Off Valve #2 is drip-tight. If the gauge needle continues to drop toward zero, then Shut-Off Valve #2 is leaking
- b. Open a fixture downstream of Shut-Off Valve #2 to create a flow and accurately determine if Shut-Off Valve #2 is holding tightly
- c. Record Shut-Off Valve #2 as pass or fail on the test form

Note: If Shut-Off Valve #2 is leaking, then you must repair or replace the valve and repeat all tests

- d. Open Shut-Off Valve #2
- e. Close all test cocks
- f. Remove the high, low and vent pressure hoses
- g. Open all control valves to drain the test gauge
- h. Remove the hose adapters from the test cocks
- i. Make sure that the water is on to the building

END OF TEST PROCEDURE –

OHIO DEPARTMENT OF COMMERCE FIELD TEST PROCEDURE USING THREE VALVE GAUGE

ASSE 1015 DOUBLE CHECK VALVE ASSEMBLY

SETUP

- a. Install hose adapters and flush test cocks #1, #2, #3, #4
 - b. Close all control valves on gauge
 - c. Close shut-off valve #2
-

TEST 1: Purpose: To test Shut-Off Valve #2
Requirement: Shut-Off Valve #2 must be drip-tight in order to obtain accurate results for Tests #2 and #3

PROCEDURE

- a. Connect the high pressure hose to test cock # 1
- b. Connect the low pressure hose to test cock # 4
- c. Open test cock #1 then open test cock #4
- d. Open the high control valve
- e. Open the vent control valve to bleed any air from the hose and gauge
- f. Close the high control valve
- g. Open the low control valve to bleed any air from the hose and gauge do not close low control valve
- h. Close the vent control valve
- i. Close Shut-off Valve #1
- j. Open the high control valve
- k. Observe the gauge reading, it should be zero (0 psi)

If the needle on the gauge remains at zero, record Shut-off Valve #2 as holding tightly

If the needle on the gauge rises above zero, record Shut-off Valve #2 as leaking and it must be repaired before you can continue the test. A reading above zero is an indication that there is a pressure head loss through the gauge as the water flows past the leaking Shut-off Valve #2

- l. Open a fixture downstream of Shut-Off Valve #2 to create a flow and accurately determine if Shut-Off Valve #2 is holding tightly
- m. Close all control valves on the gauge
- n. Close test cocks #1 and #4 and disconnect the low and high pressure hoses
- o. Open Shut-off Valve #1

CONTINUE TO TEST 2 & 3

OHIO DEPARTMENT OF COMMERCE FIELD TEST PROCEDURE USING THREE VALVE GAUGE

ASSE 1015 DOUBLE CHECK VALVE ASSEMBLY

TEST 2: Purpose: To test Check Valve #1
Requirement: Check Valve #1 must create a pressure differential of at least 1 psid

PROCEDURE

- a. Verify that all control valves and Shut-Off Valve #2 are closed
 - b. Connect the high pressure hose to test cock #2
 - c. Connect the low pressure hose to test cock #3
 - d. Open test cock #3 then open test cock #2
 - e. Open the high control valve
 - f. Open the vent control valve to bleed any air from the hose and gauge
 - g. Close the high control valve
 - h. Open the low control valve to bleed any air from the hose and gauge
 - i. Close the low control valve.
 - j. Close the vent control valve
 - k. Observe and record the gauge reading on the test form.
The gauge reading must be 1 psid or greater for check valve #1 to pass. If the gauge needle reads less than 1 psid or continues to drop toward zero, then record check valve #1 as fail
 - l. Close test cocks #2 and #3 and disconnect the low and high pressure hoses
-

TEST 3: Purpose: To test Check Valve #2
Requirement: Check Valve #2 must create a pressure differential of at least 1 psid

PROCEDURE

- a. Connect the high hose to test cock #3
- b. Connect the low hose to test cock #4
- c. Open test cock #4 then open test cock #3
- d. Open the high control valve
- e. Open the vent control valve to bleed any air from the hose and gauge
- f. Close the high control valve
- g. Open the low control valve to bleed any air from the hose and gauge
- h. Close the low control valve.
- i. Close the vent control valve
- j. Observe and record the gauge reading on the test form.
The gauge reading must be 1 psi or greater for check valve #2 to pass. If the gauge needle reads less than 1.0 psi or drops toward zero, then record check valve #2 as fail
- k. Close test cocks #3 and #4 and disconnect the low and high pressure hoses
- l. Open shut-off valve #2
- m. Open all of the control valves to drain the water in the gauge
- n. Remove the hose adapters
- o. Make sure that the water is back on to the building

- END OF TEST PROCEDURE -

OHIO DEPARTMENT OF COMMERCE FIELD TEST PROCEDURE USING THREE VALVE GAUGE

ASSE 1020 PRESSURE VACUUM BREAKER

SETUP

- a. Install hose adapters and flush test cocks #1 and #2
- b. Close all control valves on test equipment
- c. Remove the air inlet canopy

TEST 1

Purpose: To test the Air Inlet Valve
Requirement: The Air Inlet Valve must open when the pressure in the valve body drops to 1.0 psig above atmospheric pressure, and the air inlet valve must open fully when all of the water has drained from the valve body.

Note: It is important that the test gauge be positioned at the same elevation as the vacuum breaker during test #1 in order to eliminate any effect from a water column created in the hose.

PROCEDURE

- a. Connect the high hose to test cock #2
- b. Slowly open test cock #2 so that you do not slam the gauge needle
- c. Open the high control valve
- d. Open the vent control valve to bleed any air from the hose and gauge
- e. Close the vent control valve
- f. Close Shut-Off Valve #2
- g. Close Shut-Off Valve #1
- h. Slightly open the low control valve to allow the water pressure in the body of the pressure vacuum breaker to fall slowly while observing the pressure differential gauge.

You may touch (but do not push) the air inlet valve to feel for the first movement as it opens; in a quiet area you can hear the air inlet valve open.

- i. Record the pressure differential, at which the air inlet valve opened, on the test form.
The gauge reading at the point of opening must be 1 psig or greater for the air inlet valve to pass
- j. Close the low control valve
- k. Close test cock #2 and disconnect the hose
- l. Open Shut-Off Valve #1 quickly in order to reseal the air inlet valve and re-pressurize the assembly

**CONTINUE TO
TEST 2**

OHIO DEPARTMENT OF COMMERCE FIELD TEST PROCEDURE USING THREE VALVE GAUGE

ASSE 1020 PRESSURE VACUUM BREAKER

TEST 2	Purpose:	To test the Check Valve
	Requirement:	The Check Valve must be drip-tight in the normal direction of flow when the inlet pressure is 1.0 psig and the outlet pressure is atmospheric

PROCEDURE

- a. Connect the high hose to test cock #1
- b. Slowly open test cock #1 so that you do not slam the gauge needle
- c. Open the vent control valve to bleed any air from the hose and gauge
- d. Close the vent control valve
- e. Close Shut-Off Valve #1
- f. Fully open test cock #2.

This will drain the water from the body of the vacuum breaker and open the air inlet valve. When the flow from test cock #2 stops, lift the gauge to place pressure against the check valve in the direction of flow. The pressure reading indicated on the gauge will be the pressure drop across the check valve.

- g. Record the gauge reading on the test form.
The gauge reading must be 1 psig or greater for the check valve to pass.
- h. Close test cocks #1 and #2, then disconnect the hose
- i. Open Shut-off Valve #1 quickly in order to seat the air inlet valve and re-pressurize the assembly
- j. Open Shut-Off Valve #2
- k. Re-install the air inlet canopy
- l. Open all of the control valves to drain the water in the gauge
- m. Remove the hose adapters
- n. Make sure that the water is back on to the building

- END OF TEST PROCEDURE -

**OHIO DEPARTMENT OF COMMERCE
FIELD TEST PROCEDURE USING THREE VALVE GAUGE**

ASSE 1056 BACKSIPHONAGE VACUUM BREAKER

SETUP

- A. Before starting test close all valves on the test gauge
- B. Flush test cock before testing

Test No. # 1 - Differential Test of Check Valve

Requirement: Differential pressure across check must be 1.0 PSID or above

- Step 1** Remove screws on top of hood then remove hood.
- Step 2** Connect high hose of test gauge to test cock.
- Step 3** Open test cock and high valve on test gauge.
- Step 4** Open the vent (bypass) valve on the test gauge to bleed air from hose then close the vent (bypass) valve on the test gauge.
- Step 5** Close shut-off valve #2 then close shut-off valve #1 on backflow assembly.
- Step 6** Slowly unscrew bleed screw on spill proof vacuum breaker body to relieve pressure down stream of check and remove screw completely.
- Step 7** When dripping from bleed screw stops elevate gauge about 1-2 feet above device to remove loop in high hose. While gauge is elevated observe and record the differential pressure.

RESULT Differential pressure on gauge must be 1.0 PSID or greater for check to test satisfactorily.

**CONTINUE TO
TEST 2**

**OHIO DEPARTMENT OF COMMERCE
FIELD TEST PROCEDURE USING THREE VALVE GAUGE**

ASSE 1056 BACKSIPHONAGE VACUUM BREAKER

Note: For the following test the tester must be held at the same level as the assembly being tested.

Test # 2 - Air Inlet - Vent Opening

Requirement: Air inlet must start to open when supply pressure is 1.0 PSI or above.
Air inlet must be fully open when supply pressure is atmospheric

Step 8 Slowly open low (needle) valve until the vent opens slightly (1/32") then close low (needle) valve. Observe gauge and record gauge PSID. Gauge PSID must be 1.0 or greater at which vent opens to pass test as opening.

Step 9 Open low (needle) valve fully until dripping from low hose stops. While opening low (needle) valve observe vent that it opens fully.

Step 10 Visually inspect that the vent is fully open. It must be open fully to pass test satisfactorily.

Step 11 Replace and tighten bleed screw, close test cock and remove high hose.

Step 12 Open shut-off valve #1 and then open shut-off valve #2 to restore backflow device to original working condition. Replace hood and screws on top of assembly.

Note: After test, all valves on test gauge must be fully open to prevent damage to test gauge

END OF TEST PROCEDURE

OHIO DEPARTMENT OF COMMERCE BACKFLOW PREVENTION MANUAL

FIVE-VALVE ANALOG TEST GAUGE

The five-valve analog gauge works exactly the same as the three-valve analog gauge. It compares the difference between two pressures and the gauge needle indicates the difference between the two pressures. The gauge indicates pressure in pounds and two tenths of a pound as pounds per square inch differential or psid.

However due to the additional valves, the test steps are slightly different although the test procedures are exactly the same.

When testing an assembly, make sure that the high-pressure, low-pressure and vent hoses are connected to the proper test cocks. To avoid damage to the test gauge, open the test cocks slowly when bleeding air.

This illustration is intended to familiarize you with the components of the five-valve test gauge for your use in using the test procedures on pages 87 to 94.

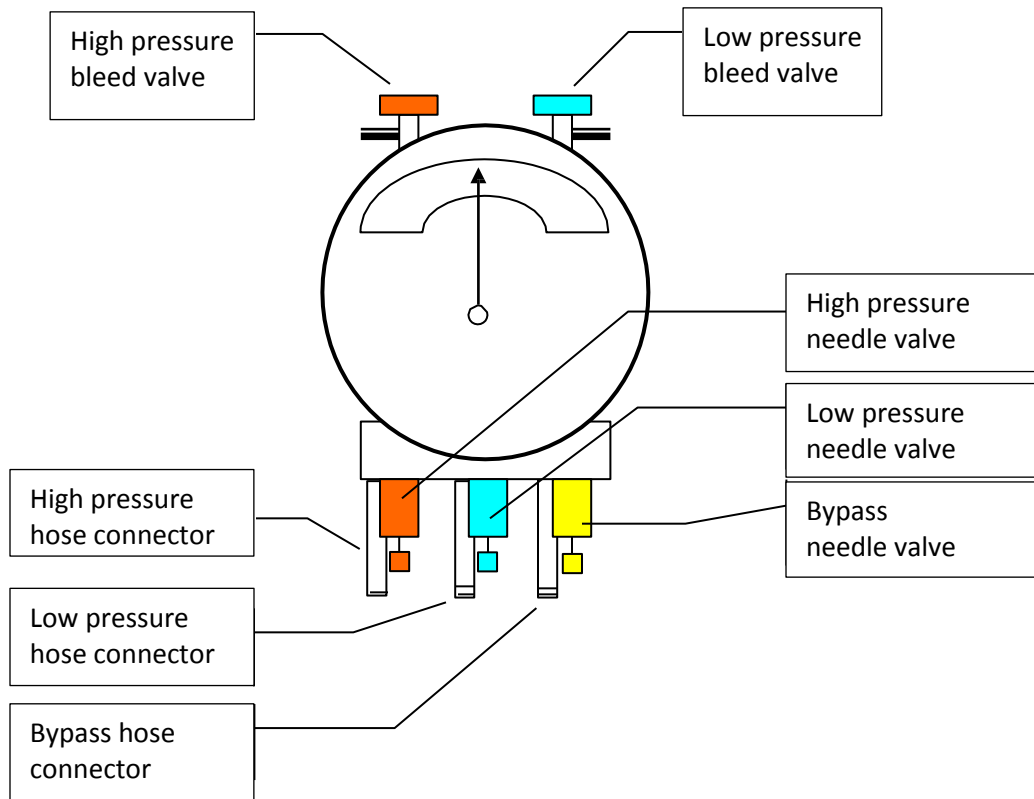

**OHIO DEPARTMENT OF COMMERCE
FIELD TEST PROCEDURE USING FIVE VALVE GAUGE**

ASSE 1013 REDUCED PRESSURE PRINCIPLE ASSEMBLY

SETUP

- a. Install hose adapters and flush test cocks #2, #3, #4
 - b. Close all control valves on the test gauge
 - c. Connect the high, low and bypass hoses to the gauge
 - d. Close shut-off valve #2
-

TEST 1: Purpose: To test Check Valve #1
 Requirement: Check Valve #1 must indicate a pressure differential equal

PROCEDURE

- a. Connect the high pressure hose to test cock #2
 - b. Connect the low pressure hose to test cock #3
 - c. Open test cock #3
 - d. Open the low pressure bleed valve to bleed air from the hose and gauge do not close low pressure bleed valve
 - e. Open test cock #2
 - k. Wait for the needle to stabilize, then open the high pressure bleed valve to bleed air from the hose and gauge
 - l. Close the high pressure bleed valve
 - m. Close the low pressure bleed valve
 - n. Observe the gauge to verify that Check Valve #1 is creating a minimum pressure differential equal to or greater than 5 psid in order to continue the test. Record the reading on the test form.
-

TEST 2: Purpose: To test the Pressure Differential Relief Valve
 Requirement: The Relief Valve must maintain a pressure differential of at least 2 psid between the Relief Valve Zone and the supply pressure

PROCEDURE

- a. Open the high pressure needle valve
- b. Slightly open the low control valve to slowly increase the water pressure in the intermediate pressure zone, the gauge needle should begin to drop toward zero and observe when water first begins to discharge from the relief port.
- c. Observe the gauge reading at which this discharge is first occurring and record the psid reading shown on the gauge.
- d. Record the Relief Valve as passed if water discharged at 2 psid or greater
- e. Compare the gauge reading obtained for Check Valve #1 and the Relief Valve. The Check Valve #1 psid must be 3psi or greater than the Relief Valve psid for Check Valve #1 to pass.
- f. Close the high and low control valves

CONTINUE TO TEST 3 & 4

OHIO DEPARTMENT OF COMMERCE FIELD TEST PROCEDURE USING FIVE VALVE GAUGE

ASSE 1013 REDUCED PRESSURE PRINCIPLE ASSEMBLY

TEST 3: Purpose: To test Check Valve #2
Requirement: Check Valve #2 must hold tightly against backpressure

PROCEDURE

- a. Loosely connect the bypass (vent) hose to test cock #4
- b. Open the vent control valve
- c. Open the low control valve to bleed any air from the hose and gauge
- d. Close the low control valve
- e. Tighten the bypass (vent) hose to test cock #4
- f. Open the high control valve
- g. While observing the gauge, open test cock #4.

The gauge needle may drop slightly then should remain static if Check Valve #2 is holding tightly. If the gauge needle does not remain static and continues to drop downward and the relief valve starts to discharge water, then check valve #2 is leaking.

- h. Record Check Valve #2 as either pass or fail on the test form

TEST 4: Purpose: To test Shut-Off Valve #2
Requirement: Shut-Off Valve #2 must be drip-tight in order to obtain accurate test readings

PROCEDURE

- a. While observing the gauge, close test cock #2

The gauge needle may drop slightly then should remain static if Shut-Off Valve #2 is drip-tight. If the gauge needle continues to drop toward zero, then Shut-Off Valve #2 is leaking

- b. Open a fixture downstream of Shut-Off Valve #2 to create a flow and accurately determine if Shut-Off Valve #2 is holding tightly
- c. Record Shut-Off Valve #2 as pass or fail on the test form

Note: If Shut-Off Valve #2 is leaking, then you must repair or replace the valve and repeat all tests

- d. Open Shut-Off Valve #2
- e. Close all test cocks
- f. Remove the high, low and bypass hoses
- g. Open all control valves to drain the test gauge
- h. Remove the hose adapters from the test cocks
- i. Make sure that the water is on to the building

- END OF TEST PROCEDURE -

OHIO DEPARTMENT OF COMMERCE FIELD TEST PROCEDURE USING FIVE VALVE GAUGE

ASSE 1015 DOUBLE CHECK VALVE ASSEMBLY

TEST 2: Purpose: To test Check Valve #1
Requirement: Check Valve #1 must create a pressure differential of at least 1 psid

PROCEDURE

- a. Verify that all control valves and Shut-Off Valve #2 are closed
 - b. Connect the high pressure hose to test cock #2
 - c. Connect the low pressure hose to test cock #3
 - d. Open test cock #3
 - e. Open the low pressure bleed valve to bleed air from the hose and gauge
 - f. Open test cock #2
 - g. Allow the gauge needle to stabilize, then open the high pressure bleed valve to bleed air from the hose and gauge
 - h. Close the high pressure bleed valve
 - i. Close the low pressure bleed valve
 - j. Observe and record the gauge reading on the test form.
The gauge reading must be 1 psid or greater for check valve #1 to pass. If the gauge needle reads less than 1 psid or drops toward zero, then record check valve #1 as fail
 - k. Close test cocks #2 and #3 and slowly bleed the gauge pressure through the bleed valves
-

TEST 3: Purpose: To test Check Valve #2
Requirement: Check Valve #2 must create a pressure differential of at least 1 psid

PROCEDURE

- a. Connect the high pressure hose to test cock #3
- b. Connect the low pressure hose to test cock #4
- c. Open test cock #4
- d. Open the low pressure bleed valve to bleed air from the hose and gauge
- e. Open test cock #3
- f. Allow the gauge needle to stabilize, then open the high pressure bleed valve to bleed air from the hose and gauge
- g. Close the high pressure bleed valve
- h. Close the low pressure bleed valve
- i. Observe and record the gauge reading on the test form.
The gauge reading must be 1 psid or greater for check valve #2 to pass. If the gauge needle reads less than 1 psid or drops toward zero, then record check valve #2 as fail
- j. Close test cocks #3 and #4 and slowly bleed the gauge pressure through the bleed valves
- k. Open shut-off valve #2
- l. Open all of the control valves to drain the water in the gauge
- m. Remove the hose adapters
- n. Make sure that the water is back on to the building

- END OF TEST PROCEDURE -

OHIO DEPARTMENT OF COMMERCE FIELD TEST PROCEDURE USING FIVE VALVE GAUGE

ASSE 1020 PRESSURE VACUUM BREAKER

SETUP

- a. Install hose adapters and flush test cocks #1 and #2
 - b. Connect the high, low and bypass hoses to the gauge
 - c. Close all control valves on test equipment
 - d. Remove the air inlet canopy
-

TEST 1: Purpose: To test the Air Inlet Valve
Requirement: The Air Inlet Valve must open when the pressure in the valve body drops to 1 psig above atmospheric pressure, and the air inlet valve must open fully when all of the water has drained from the valve body.

Note: It is important that the test gauge be positioned at the same elevation as the vacuum breaker during test #1 in order to eliminate any effect from a water column created in the hose.

PROCEDURE

- a. Connect the high pressure hose to test cock #2
- b. Open the high pressure bleed valve
- c. Slowly open test cock #2 so that you do not slam the gauge needle
- d. Close the high pressure bleed valve
- e. Close Shut-Off Valve #2
- f. Close Shut-Off Valve #1
- g. Slightly open the high pressure bleed valve to allow the water pressure in the body of the pressure vacuum breaker to fall slowly while observing the pressure differential gauge.

You may touch (but do not push) the air inlet valve to feel for the first movement as it opens; in a quiet area you can hear the air inlet valve open.

- h. Record the pressure differential, at which the air inlet valve opened, on the test form.
The gauge reading at the point of opening must be 1 psig or greater for the air inlet valve to pass
- i. Close test cock #2 and disconnect the hose
- j. Open Shut-Off Valve #1 quickly in order to reseal the air inlet valve and re-pressurize the assembly

**CONTINUE TO
TEST 2**

OHIO DEPARTMENT OF COMMERCE FIELD TEST PROCEDURE USING FIVE VALVE GAUGE

ASSE 1020 PRESSURE VACUUM BREAKER

TEST 2 Purpose: To test the Check Valve
Requirement: The Check Valve must be drip-tight in the normal direction of flow when the inlet pressure is 1.0 psig and the outlet pressure is atmospheric

PROCEDURE

- a. Connect the high pressure hose to test cock #1
- b. Open the high pressure bleed valve
- c. Slowly open test cock #1 so that you do not slam the gauge needle
- d. Close the high pressure bleed valve
- e. Close Shut-Off Valve #1
- f. Fully open test cock #2.

This will drain the water from the body of the vacuum breaker and open the air inlet valve. When the flow from test cock #2 stops, lift the gauge to place pressure against the check valve in the direction of flow. The pressure reading indicated on the gauge will be the pressure drop across the check valve.

- g. Record the gauge reading on the test form.
The gauge reading must be 1 psig or greater for the check valve to pass.
- h. Close test cocks #1 and #2, then disconnect the hose
- i. Open Shut-off Valve #1 quickly in order to seat the air inlet valve and re-pressurize the assembly
- j. Open Shut-Off Valve #2
- k. Re-install the air inlet canopy
- l. Open all of the needle valves to drain the water in the gauge
- m. Remove the hose adapters
- n. Make sure that the water is back on to the building

- END OF TEST PROCEDURE -

**OHIO DEPARTMENT OF COMMERCE
FIELD TEST PROCEDURE USING FIVE VALVE GAUGE**

ASSE 1056 BACKSIPHONAGE VACUUM BREAKER

SETUP

- A. Before starting test close all valves on the test gauge
- B. Flush test cock before testing

Test No. # 1 - Differential Test of Check Valve

Requirement: Differential pressure across check must be 1.0 PSID or above

- Step 1** Remove screws on top of hood then remove hood.
- Step 2** Connect high hose of test gauge to test cock.
- Step 3** Open test cock and high valve on test gauge.
- Step 4** Open high pressure bleed valve on test gauge to bleed air from hose then close high pressure bleed valve on test gauge.
- Step 5** Close shut-off valve #2 then close shut-off valve #1 on backflow assembly.
- Step 6** Slowly unscrew bleed screw on spill proof vacuum breaker body to relieve pressure down stream of check and remove screw completely.
- Step 7** When dripping from bleed screw stops elevate gauge about 1-2 feet above device to remove loop in high hose. While gauge is elevated observe and record the differential pressure.

RESULT Differential pressure on gauge must be 1.0 PSID or greater for check to test satisfactorily.

CONTINUE TO
TEST 2

OHIO DEPARTMENT OF COMMERCE FIELD TEST PROCEDURE USING FIVE VALVE GAUGE

ASSE 1056 BACKSIPHONAGE VACUUM BREAKER

Note: For the following test the tester must be held at the same level as the assembly being tested.

Test # 2 - Air Inlet - Vent Opening

Requirement: Air inlet must start to open when supply pressure is 1.0 PSI or above.
Air inlet must be fully open when supply pressure is atmospheric

Step 8 Slowly open low (needle) valve until the vent opens slightly (1/32") then close low (needle) valve. Observe gauge and record gauge PSID. Gauge PSID must be 1.0 or greater at which vent opens to pass test as opening.

Step 9 Open low (needle) valve fully until dripping from low hose stops. While opening low (needle) valve observe vent that it opens fully.

Step 10 Visually inspect that the vent is fully open. It must be open fully to pass test satisfactorily.

Step 11 Replace and tighten bleed screw, close test cock and remove high hose.

Step 12 Open shut-off valve #1 and then open shut-off valve #2 to restore backflow device to original working condition. Replace hood and screws on top of assembly.

Note: After test, all valves on test gauge must be fully open to prevent damage to test gauge

END OF TEST PROCEDURE

STATE OF OHIO

Annual Test & Maintenance Report for Backflow Prevention Assemblies

Facility Name: _____ Contact Person _____

Complete Address: _____

Assembly Information

Make _____
 Model _____ Size _____
 Serial Number _____

Installation Information

Meter Pit Basement Floor Number _____
 Penthouse Boiler Room Room Number _____
 Mechanical Room Protection Provided _____

Containment Isolation

Double Check Assembly

Initial Test	Outlet Valve		Pass <input type="checkbox"/>
			Fail <input type="checkbox"/>
	1 st Check Valve	__psid	Pass <input type="checkbox"/>
			Fail <input type="checkbox"/>
	2 nd Check Valve	__psid	Pass <input type="checkbox"/>
			Fail <input type="checkbox"/>

Reduced Pressure Assembly

1 st Check Valve	__psid	Pass <input type="checkbox"/>
		Fail <input type="checkbox"/>
Relief Valve Opening Point	__psid	Pass <input type="checkbox"/>
		Fail <input type="checkbox"/>
2 nd Check Valve		Pass <input type="checkbox"/>
		Fail <input type="checkbox"/>
Outlet Valve		Pass <input type="checkbox"/>
		Fail <input type="checkbox"/>

Pressure Vacuum Breaker

Air Inlet Valve	__psig	Pass <input type="checkbox"/>
		Fail <input type="checkbox"/>
Check Valve	__psig	Pass <input type="checkbox"/>
		Fail <input type="checkbox"/>

Repairs & Materials Used	
-------------------------------------	--

--

--

Re-Test After Repair	Outlet Valve		Pass <input type="checkbox"/>
			Fail <input type="checkbox"/>
	1 st Check Valve	__psid	Pass <input type="checkbox"/>
			Fail <input type="checkbox"/>
	2 nd Check Valve	__psid	Pass <input type="checkbox"/>
			Fail <input type="checkbox"/>

1 st Check Valve	__psid	Pass <input type="checkbox"/>
		Fail <input type="checkbox"/>
Relief Valve Opening Point	__psid	Pass <input type="checkbox"/>
		Fail <input type="checkbox"/>
2 nd Check Valve		Pass <input type="checkbox"/>
		Fail <input type="checkbox"/>
Outlet Valve		Pass <input type="checkbox"/>
		Fail <input type="checkbox"/>

Air Inlet Valve	__psig	Pass <input type="checkbox"/>
		Fail <input type="checkbox"/>
Check Valve	__psig	Pass <input type="checkbox"/>
		Fail <input type="checkbox"/>

Comments:

TESTER CERTIFICATION: *I hereby certify that the above data is correct and that the backflow prevention device is in proper working condition.*

Tester Name (Printed) _____ Signature _____

Company Name _____ Ohio Cert. No. _____ Contractor No. _____

I hereby certify that the above backflow prevention device has been in constant use at this location during the entire prescribed interval between test periods and during that period this device was not bypassed, made inoperative, or removed without proper authorization. I further certify that I have the authority and responsibility to ensure the above.

Owner/Officer (Printed) _____ Signature _____

Title: _____ Date: _____

DEPARTMENT OF COMMERCE BACKFLOW PREVENTION MANUAL

TEST GAUGE

The test gauge should be carried in a sturdy case and protected from freezing conditions. If you suspect that the gauge has been damaged, from dropping or freezing, then the gauge should be re-calibrated before being used.

There currently is no State requirement that the gauge must be re-calibrated annually, but this is a recommended practice.

The calibration is required under the authority having jurisdiction and the tester shall be familiar with the requirements of the local authority when and how often test gauges need recalibration.

DEPARTMENT OF COMMERCE BACKFLOW PREVENTION MANUAL

TESTER SAFETY

All safety precautions as outlined in the applicable OSHA subpart sections should be followed when working from ladders, in confined spaces and other working conditions covered by OSHA regulations.

You should test the atmosphere in a pit before entering to determine that the oxygen levels are appropriate. Additionally, many companies will require the use of approved safety apparatus if you are entering a “confined space”. Check with the company contact person before entering a confined space.

Oxygen sensors are commercially available for testing the atmosphere. Keep in mind that if you are going to invest the money in a sensor then you may want to invest a little more and purchase a sensor that detects oxygen, methane gas, carbon dioxide, and explosive or flammable gases.

You will have to repair a backflow prevention device if it fails your test. For the safety of your customer, it is recommended that you have appropriate repair parts with you or ready access to repair parts so that you can return the backflow preventer to service after the test.

When you have to repair a backflow preventer, you must exercise caution when removing the cap to gain access to the check valve. Remember that the spring may be tensioned against the cap and will be exerting pressure against it.

This is especially important when removing the cap from a device that is greater than two inches in size. It is recommended that you carry two long bolts in your toolbox. You may then remove two bolts from the cap and insert the longer bolts. You may then remove the remaining bolts safely and slowly back-out the two longer bolts. The spring tension against the cap is relieved when you can push the cap downward with your hands.

Often backflow prevention devices are not easily accessible (this writer has seen them installed thirty feet in the air). Remember when you install a backflow prevention device that you may be the one who is also asked to test or repair it.

The water supplier will have specific installation requirements for a containment principle backflow prevention device. Check with the water supplier before beginning the installation.

There are few installation requirements for an isolation device at present. These should be installed according to the applicable plumbing code installation requirement or the manufacturer’s recommendations if there is no direction in the plumbing code.

REDUCED PRESSURE BACKFLOW PREVENTION DEVICE

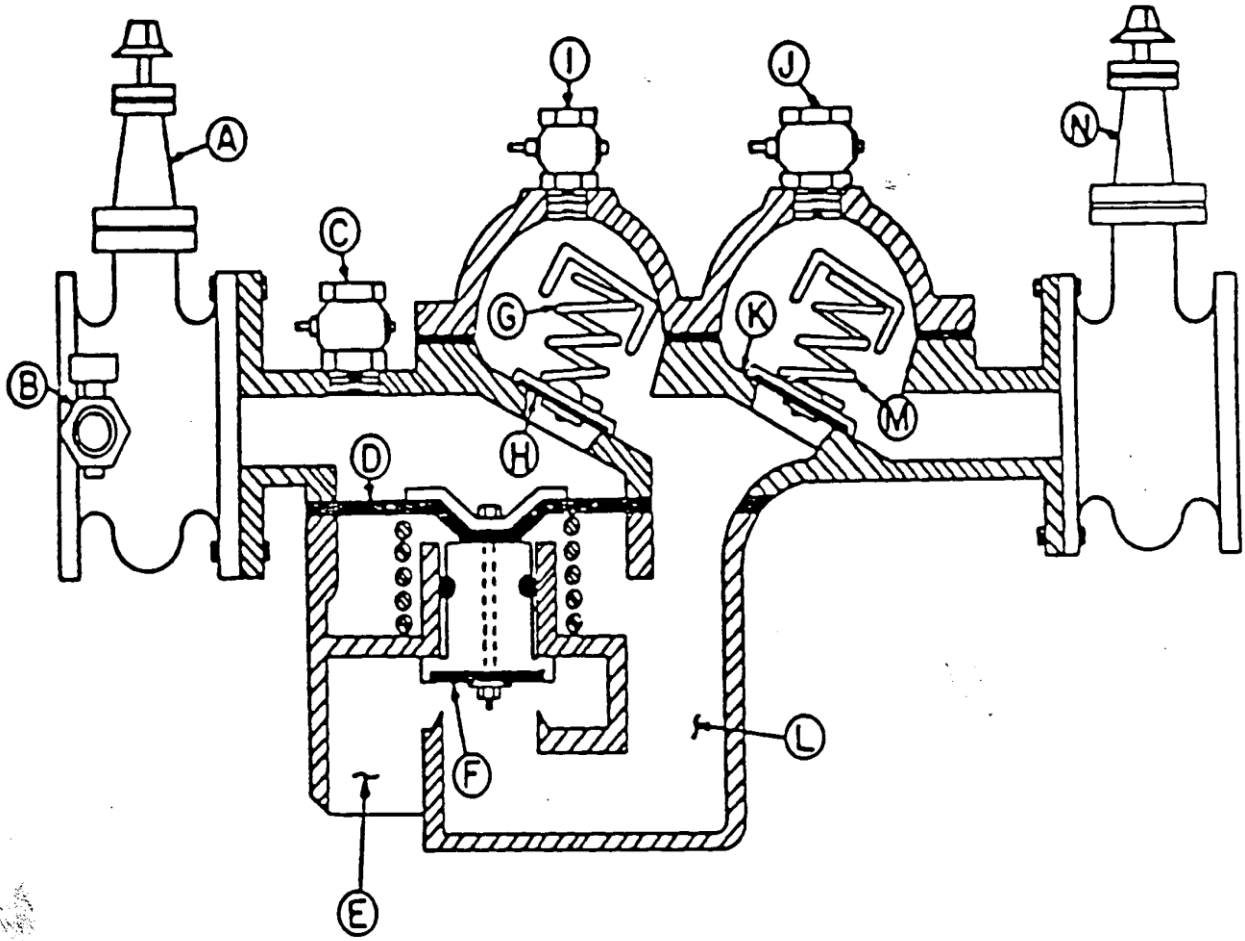

A	
B	
C	
D	
E	
F	
G	
H	
I	
J	
K	
L	
M	
N	

DOUBLE CHECK VALVE ASSEMBLY

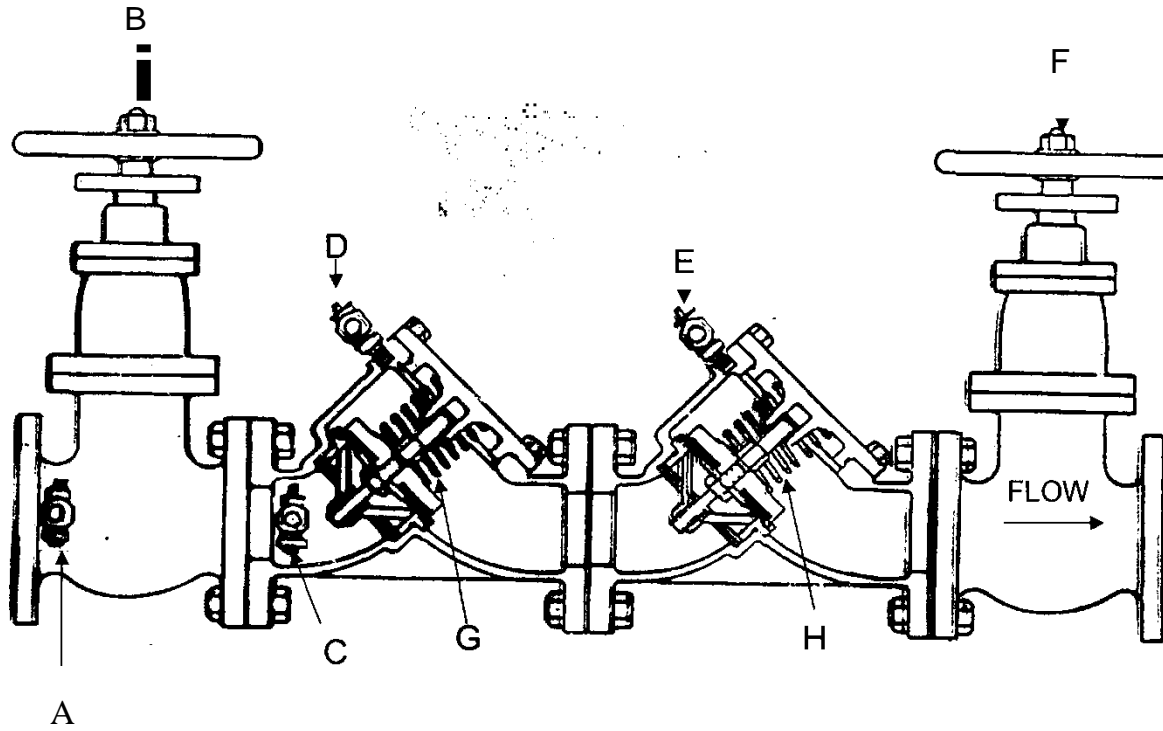

A
B
C
D
E
F
G
H

NAME _____ PRESSURE VACUUM BREAKER

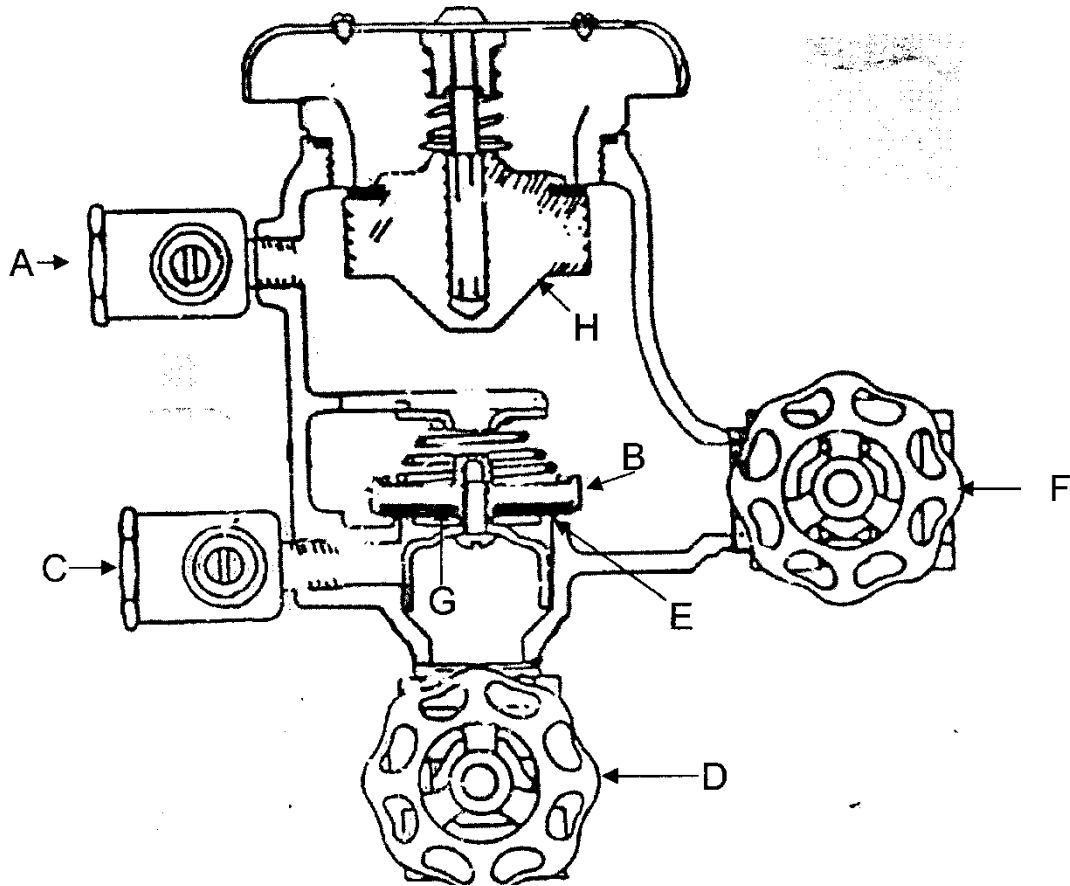

A
B
C
D
E
F
G
H