

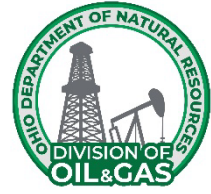

SCOPE OF WORK
ASHTABULA #12 PROJECT
Multiple Orphan Well Sites
Ashtabula County, Monroe & Colebrook Townships



PROJECT DESCRIPTION

The Ashtabula #12 project shall include the following wells:

Wells to be plugged per the individual plugging plan.

Well Name	API Number	County	Township	<u>Ingress/Egress Latitude, Longitude</u>	<u>Wellhead Latitude, Longitude</u>
John Pazdziorko #1	34-007-2-0034-00-00	Ashtabula	Monroe	41.870298, -80.588180	41.868866, -80.588229
JA Zevchik Unit #1	34-007-2-1658-00-00	Ashtabula	Colebrook	41.520851, -80.810182	41.520606, -80.809030

PROJECT SCOPE OF WORK:

This project includes mobilization, access and well site development, drilling or cleaning out of and plugging of two (2) Orphan Wells, storage and disposal of all materials generated during the plugging of the well, decommissioning, removal, storage and disposal of all casing, tubing, well and production equipment and affiliated lines and restoration of all areas disturbed during this project.



SCOPE OF WORK
ASHTABULA #12 PROJECT
Multiple Orphan Well Sites
Ashtabula County, Monroe & Colebrook Townships

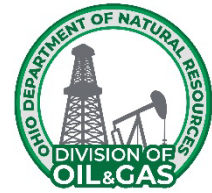

GENERAL SCOPE OF WORK

The Contractor, the Contractor's agents, representatives, and subcontractors shall perform this Plugging Project in accordance with Ohio Revised Code 1509, Ohio Administrative Code Chap. 1501:9-11 and 1501:9-12, the Agreement, and in accordance with the following documents that are attached hereto and made a part hereof:

1. Project Description;
2. General Scope of Work;
3. General Conditions;
4. General Specifications;
5. Sequence of Work;
6. Well Description;
7. Plugging Plan;
8. Detailed Specifications;
9. Appendix I – Ohio One-Call;
10. Appendix II – Well Records;
11. Quantity Sheet;
12. & Drawing Plan Set.

Subject to the Contractor's compliance with this Scope of Work, Contractor is solely responsible for and has control over all plugging and reclamation construction means, methods, manners, techniques, sequences, and procedures, for safety precautions and programs in connection with the Plugging Project, and for coordinating all portions of the Plugging Project.



SCOPE OF WORK
ASHTABULA #12 PROJECT
Multiple Orphan Well Sites
Ashtabula County, Monroe & Colebrook Townships

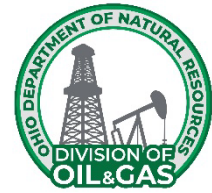

GENERAL CONDITIONS

PART 1: OHIO DEPARTMENT OF TRANSPORTATION SPECIFICATIONS

This Ashtabula #12 Project (Project) references the Ohio Department of Transportation (ODOT) Construction and Material Specifications (ODOT CMS). Any reference to these specifications is to ODOT's most current version of the specifications. The ODOT CMS can be found at <https://www.dot.state.oh.us/Divisions/ConstructionMgt/OnlineDocs/Pages/2023-Online-Spec-Book.aspx>

PART 2: PRE-SITE MEETING

The Contractor or Contractor's representative must attend the pre-site meeting. Failure to attend the pre-site meeting is grounds for the Division to reject the Contractor's Offer.

The Ohio Department of Natural Resources, Division of Oil & Gas Resources Management (Division) intends to begin the pre-site meeting on time. At the meeting, the Division will circulate and collect attendance sign-in forms to all contractors present. Only those contractors in attendance throughout the pre-site meeting, including the discussion of the Scope of Work, will be considered present for the pre-site meeting.

PART 3: MODIFICATIONS TO THE SCOPE OF WORK PRIOR TO AWARD

The Scope of Work may only be altered by written modification. The Division may issue an Amendment to the Scope of Work and will provide a notification of the Amendment by email to all Department of Administrative Services (DAS) pre-qualified contractors. Each contractor is responsible for logging into OhioBuys and submitting an offer that is responsive to all Amendments issued. All offers submitted prior to an amendment being issued shall become null/void and not consider in the opening. All Amendments shall become part of the Scope of Work.

Any interpretation or clarification of the Scope of Work made by any person other than the Division, or in any manner other than a written Amendment, is not binding and the Contractor cannot rely upon any such interpretation or clarification.

The Contractor cannot, at any time after the award of the Scope of Work be compensated for any issue with the Scope of Work, including alleging insufficient data, incomplete, ambiguous, conflicting, or erroneous language, or incorrectly assumed conditions regarding the nature or character of the work.

PART 4: PERMIT AND INSPECTION REQUIREMENTS

The Division will obtain and pay for all building and U.S. Army Corps of Engineers permits unless otherwise specified in the Detailed Specifications. However, the Contractor shall determine and include in his or her Offer Sheet the costs required to obtain and pay for all other requirements by the applicable governmental agencies; including but not limited to, all certificates of inspection/operation, guarantees, licenses, etc. required to complete the work as described within this document. The contractor shall follow

all applicable laws and permit requirements and the Division will not be held responsible for damages that result from violation of laws or permits.

PART 5: INSTRUCTIONS FOR PREPARING AN OFFER

A Contractor's offer must be submitted online through **OhioBuys**. (<https://procure.ohio.gov/bidders-and-suppliers>). **All offers submitted prior to an Amendment being issued shall automatically become null/void and not consider in the opening.**

Offers shall include labor, equipment, and material cost plus a proportionate share of the Contractor's overhead costs, other indirect costs, and anticipated profit. An offer must be mathematically and materially balanced. A "mathematically unbalanced offer" is an offer containing lump sum or unit price items that do not include reasonable labor, equipment, and material costs plus a reasonable proportionate share of the Contractor's overhead costs, other indirect costs, and anticipated profit. A mathematically unbalanced offer typically contains token prices (i.e. \$1 prices), front loadings, or prices with large variations from the engineer's estimate. A "materially unbalanced offer" is a mathematically unbalanced offer that will not result in the lowest ultimate cost to the Division.

During the Division's initial review of offers, if the Division finds an offer may be mathematically unbalanced, the Contractor may be required to submit proof of the mathematically unbalanced line items' proposed cost within 24 hours after notification from the Division. At a minimum, a Contractor may be required to submit copies of all material/rental quotes, intended labor costs (hours/rates), and contract agreements with subcontractors to support their offer. If the Contractor fails to submit the required proof, the Contractor's offer shall be deemed withdrawn from consideration. The Division shall evaluate the documentation and may verify quotes with vendors. After a review of the documentation, the Division will reject any offer it determines is mathematically and materially unbalanced.

A Contractor shall maintain an up-to-date schedule on file with the Division that sets forth dates by which the Contractor will plug each well that the Division previously awarded to the Contractor. A Contractor shall update their work schedule as often as necessary to maintain a current schedule with the Division. To be awarded new contracts, the Contractor must be able to complete all previously awarded work within the due dates set in each contract with the Division. Upon request, a Contractor shall provide an up-to-date schedule to the Division that reflects when all awarded work will be completed.

Please note that a Contractor's offer must be submitted online through OhioBuys.

1. Refer to the Scope of Work posted in OhioBuys with this solicitation.
2. **Only Contractors who are pre-qualified to offer this service on an existing State Contract beginning with CSP900-922 (DAS Index No. MAC110) may respond to this solicitation.** All CSP900922 Contract Terms & Conditions apply to this solicitation. No additional terms and conditions will be accepted. The Division will reject Offers from any Contractor that is not pre-qualified.
3. Completion of the grid is required and will be considered the response for evaluation. No outside or additional documentation will be considered.
4. Fixed prices will be automatically added to Contractor's proposals when shown. Contractors are not to enter pricing for fixed price items.
5. Confirm that your bid has been successfully imported into OhioBuys for all items before submitting. Incomplete bids and/or attachments will not be evaluated.
6. The most recent bid submitted in OhioBuys will be the bid that is evaluated, all prior bids submitted in the same solicitation will not be evaluated.
7. **The Contractor or Contractor's representative must attend the site meeting.** Failure to attend the site meeting is grounds for the Division to reject the Contractor's Offer.

PART 6: DIVISION'S OFFER SELECTION

Except when the Division rejects an offer, the Division will select the lowest offer submitted to the Division. The Division may reject an offer if any one of the following applies to the Contractor's offer:

- Is not submitted online through **OhioBuys**;
- Fixed reference prices and/or any other imported information is incorrectly and/or not imported into **OhioBuys**;
- Is conditional;
- Is a mathematically unbalanced offer and a materially unbalanced offer;
- Is behind schedule on other projects with the Division; or
- Is not able to schedule this project within the contract due dates.

PART 7: WITHDRAWAL OF OFFERS

At any time prior to the opening of the Offers, a Contractor may submit a written request to the Division, at the location where the Offers are received, to withdraw its offer. The request to withdraw the Offer must be signed by the person who executed the Offer.

PART 8: EFFECTIVE DATE AND TERM

The effective date of this Project is the date of the Letter to Proceed that is sent to the Contractor. The Contractor must start work at the project site within three (3) months of the end of the contract and the Contractor shall continue diligently working toward the completion of the project once work has commenced. The Project must be completed **six (6) months after the effective date** or by June 30, 2025, whichever is sooner. If the Project terminates on June 30, 2025 and the Project is not completed, the Scope of Work may be renewed on the same terms if the Division sends written notice to the Contractor. Failure to complete work by the contract due dates may result in the suspension or termination of the contract and may result in the Division pursuing the Suspension and Termination and/or the Contract Remedies sections defined in the MAC 110 contract.

PART 9: TERMINATION AT WILL

The Division may terminate this Scope of Work without cause. Any payment due to the Contractor at the time of termination by the Division shall be paid to the Contractor on a pro rata basis.

PART 10: RELATIONSHIP BETWEEN COMPONENTS OF THE SCOPE OF WORK

This Scope of Work includes drawings that are duplicates of drawings on file with the Division. The Scope of Work documents are complementary. All sections of the Scope of Work are binding. The titles and headings in the Scope of Work are for reference and in no way affect the interpretation of the provisions of the Scope of Work. Further, if any part of this Scope of Work is found to be unenforceable, no such event will affect the enforceability or applicability of any other part of the Scope of Work.

If a conflict between the drawings and the specifications arises, the Contractor must notify the Division. In the event of a conflict of any provision in the Scope of Work the order of priority within the Scope of Work is as follows: Drawings, Detailed Specifications, General Specifications, Plugging Plan, and Sequence of Work.

PART 11: CONTRACTOR'S RESPONSIBILITY FOR SUBCONTRACTORS

The Contractor is responsible for the conduct of its subcontractors and for persons its subcontractors directly or indirectly employ.

PART 12: USE OF DOMESTIC STEEL AND BUY AMERICAN ACT **(For Federally Funded Projects only)**

For infrastructure projects that utilize federal funds, the contractor and subcontractors shall comply with Executive Order No. 14005 Ensuring the Future Is Made in All of America by All of America's Workers; the Code of Federal Regulations Title 2, Subtitle A, Chapter I, Part 184; U.S.C. 52.225-11 Buy American-Construction Materials under Trade Agreements (Nov 2023) clause; and Buy America Preferences for Infrastructure Projects and the Infrastructure and Jobs Act (Public Law 117-58) Division D, Title IX, Subtitle A, Part I, Buy America Sourcing Requirements. The contractor and subcontractors are required by law to supply domestically produced iron or steel products, manufactured products, and construction materials such as non-ferrous metals (steel, iron, aluminum), plastics, PVC pipe, glass, fiber optic cable, optical fiber, engineered wood, and lumber products for infrastructure on all projects funded in whole or in part with federal funds. The Infrastructure, Investment, and Jobs Act (Public Law 117-58) Division D, Title IX, Subtitle A, Part I, Buy America Sourcing Requirements exempts cement, cementitious materials, aggregates such as stone, sand, gravel, or aggregate binding agents or additives from these requirements.

PART 13: STANDARDS

If the Division identifies a "standard" by reference to manufacturer and/or model number, all offers will be evaluated to ensure that the identified standard is used. The Division will not consider an offer in which a substitution for the standard is offered. After the Letter to Proceed is issued, the Contractor may submit a written proposal for a substitution of a standard.

PART 14: SUBSTITUTIONS DURING THE PROJECT

After the Letter to Proceed is issued, the Contractor may offer substitutions for the standards set forth in the Scope of Work. The decision to allow substitution is solely within the discretion of the Division, which will consider, among other factors, availability, time of delivery, the aesthetic value of the proposed substitution, general differences in the knowledge of the product, service history, quality, efficiency, performance, and architectural, engineering, inspection, testing and administrative expenses. Any changes to the Offer price and/or Scope or Work must be memorialized by a Field Order or Change Order, as applicable. The savings in cost in allowing any substitutions during the Project will be solely to the benefit of the Division.

PART 15: QUANTITIES OF WORK

15.1 Unit Price Items

For items in the Offer that require a unit price, the quantities listed on the Offer Sheet are an approximation and are to be used only for the comparison of offers. The scheduled quantities may be increased or decreased without invalidating or altering the Offer and will be considered within the Scope of Work.

Payments for unit price items will be made to the Contractor for actual quantities of work performed and materials furnished in accordance with the Scope of Work; however, the Contractor may not exceed the unit quantities shown on the Offer Sheet without prior written approval of the Division

through a Field Order. Even if the Contractor determines that additional unit priced quantities (above and beyond the original Offer Sheet quantity) are required to meet plan and/or specification dimensions, the Contractor must not exceed the Offer Sheet quantities without prior written approval of the Division. The Division will not pay for quantities above and beyond the Offer Sheet quantity without prior written approval of the Division.

15.2 Lump Sum Items

For items in the Offer Sheet that require a lump sum price, the Division will not pay for work, materials, or equipment that exceeds the amount provided by the Contractor on the Offer Sheet. The lump sum price on the Offer Sheet must include all work, materials, and equipment necessary to properly complete the Project.

15.3 Additional/Contingency Items

The contingency items set forth in the Offer Sheet are not projected as necessary to complete the Project. Rather, the contingency items will first be used when unforeseen work arises, and the Division determines the contingency item is applicable. To be compensated for contingency items, the Contractor must have a written Field Order from the Division authorizing the contingency item in a specified quantity. Use of contingency items will not require the execution of a Change Order. The Contractor must be prepared to supply all items identified in the contingency specifications for use on this Project.

PART 16: OMISSIONS IN THE SCOPE OF WORK

If the Contractor notices an error or omission in the Scope of Work during performance of the Project, the Contractor shall immediately notify the Division of such omission or error and shall not proceed with the Project until directed by the Division. Any work performed by the Contractor prior to clarification by the Division may not be entitled to compensation.

PART 17: INTERPRETATIONS CONCERNING THE SCOPE OF WORK

During the Project, if a question arises on the Scope of Work, the labor or materials to be supplied, or costs potentially exceeding the Contractor's Offer, such questions must, prior to the work being performed, be submitted to the Division for a determination. A Division determination will be issued in writing and any work performed prior to such a determination will be performed at no cost to the Division. The Division will also begin executing a Change Order, when appropriate.

If the Division receives a written question concerning the Project, the Division will determine if the work must be performed by the Contractor at no increase in price to the Scope of Work. If so, the Division will issue a Field Order setting forth the Division's determination. Each Field Order issued must be signed by the Contractor acknowledging receipt. If the Contractor disagrees with the Division's interpretation in a Field Order, the Contractor may submit a protest by certified mail to the Chief within ten (10) days following the date of issuance of the protested Field Order. However, the Contractor must immediately proceed with the instructions given in the issued Field Order.

If, upon receipt of a written protest of a Field Order, the Division determines that the work referred to in the protest is outside the Scope of Work, the Division will not issue a Field Order and instead will issue a Change Order.

Field Orders, which are interpretations of the requirements of the Scope of Work, may be issued by the Division at any time during the performance of the work. The Contractor, at all times, is required to immediately execute the instructions of all issued Field Orders.

PART 18: CHANGES IN THE SCOPE OF WORK

18.1 The Division's Right to Require Change Orders

The Division may issue a Change Order directing the Contractor to immediately perform extra work that differs from the Scope of Work. The Contractor shall perform the work as directed. The changes in the work will consist of additions, deletions, or other revisions. When the Contractor performs the work, the Offer amount will be adjusted as described within this Scope of Work.

If the Contractor protests the issuance of the Change Order, any such protest has no bearing on any work requirements arising out of the Change Order in that the Contractor must immediately perform the work required in the Change Order so as not to delay the progress of the work at the Project.

18.2 Unauthorized Work

Only work performed under the Scope of Work or work authorized by a Field Order or a Change Order is eligible for compensation. If the Contractor performs any work or purchases any materials without an approved, applicable Field Order or Change Order, such work performed, and purchases made are within the Scope of Work at no additional cost to the Division.

18.3 Contractor's May Request Change Orders

If the Contractor determines that the Scope of Work does not address conditions at the Project, the Contractor may provide written notice to the Division of the conditions and request a Change Order. No oral communications will be acceptable as justification for a Change Order.

18.4 Determining Price of a Proposed Change Order

The following methods will be used to determine the price of a proposed Change Order:

- a. If a Change Order involves items not listed on the Offer Sheet, the Contractor must present the Division with labor and/or material price quotes for the proposed Change Order item(s). The Division may request these quotes either in unit prices or as lump sums; or
- b. If the work involved in the Change Order is not definable, the Division may request the work be performed on a time and material basis and include a maximum amount to be paid for the work. The method will be based on unit prices for both labor and materials agreed to by the Division prior to the Contractor commencing the work.

18.5 Disputes Regarding Change Order Prices

If the Contractor and the Division cannot agree on the cost of the work for a Change Order, using site-specific information including, but not limited to, Division historic public offer information, the Division will determine and set a fair price for the work and materials that are the subject of the Change Order.

PART 19: PAY ESTIMATES

19.1 General Information

Payments issued to the Contractor as the work progresses are not acceptance of any portion of the work not completed in accordance with the Scope of Work nor do such payments relieve the Contractor of liability with respect to any obligation or any expressed or implied warranties or responsibilities for faulty materials or workmanship.

19.2 Required Review by the Division

Prior to the submittal of each payment request, the Contractor and the Division must meet at the Project site to review the Project progress. The Contractor and the Division's Project Representative must mutually agree on quantity and percent of work completed for all offer items prior to submittal of each payment request. No payment request will be approved for work that has not been approved by the Division's Project Representative. Field verification of all lump sum quantities and weight slips for all unit price quantities invoiced must be submitted to the Division's Project Representative for review during the meeting.

The Contractor's payment request must be submitted to the Division via the Orphan Well Program email at OrphanWellProgram@dnr.ohio.gov. The payment request must include a form furnished by the Division along with all backup documentation. The Division will confirm in writing that the payment request is accurate.

For Federally Funded Projects: The Contractor/Subcontractor shall submit payroll reports with each Payment Request. Payroll reports shall be completed according to Part 3 of the **Davis-Bacon Requirements** included in the Scope of Work.

Payment requests received by the Division containing errors or requesting amounts that cannot be approved will be returned to the Contractor. The Contractor may resubmit a payment request after correcting errors.

19.3 Documents to be Submitted for Payment

Once the Division confirms the payment request is accurate, the contractor may submit an invoice on company letterhead to Ohio Shared Services at invoices@ohio.gov. Refer to the instruction on the payment request form furnished by the Division for additional submittal details.

With each request for payment the Contractor certifies that:

- a. The request for payment is accurate as to materials and the work completed under the terms and conditions of the Scope of Work and any Change Order, as applicable, including full compliance with all labor provisions; and
- b. All subcontractors and material suppliers have been paid for the work or materials that are applicable to all previous payment requests. As certification, each request for payment, at the Division's request, may need to be accompanied with a properly executed "Waiver of Liens" from all subcontractors and material suppliers to show that all previous payments made by the Division to the Contractor have been applied to fulfill, in full, all of the Contractor's obligations reflected in prior requests for payment.

19.4 Effect of Liens on Payment Requests

All work, materials, and equipment covered by any request for payment, whether incorporated in the Project or not, will pass to the Division at the time of payment free and clear of all liens, claims, security interests and encumbrances.

If there is evidence of any lien or claim that is chargeable to the Contractor, the Division will withhold all payments due to the Contractor to secure such lien or claim. If there are any previous liens or claims after payments are made to the Contractor, the Contractor may be required to refund to the Division a sum of money equal to the sum of all monies that the Division may be compelled to pay in discharging any lien or claim as a result of the Contractor's default.

PART 20: RETAINAGE FOR FINAL STABILIZATION

If the Scope of Work requires revegetation of disturbed area, the Division will retain five percent (5%) of the sum of (1) the Offer amount and (2) all approved Change Orders. The five percent (5%) amount retained shall be released once the Division completes a Final Stabilization Inspection and determines that vegetation has reached final stabilization. "Final stabilization" means vegetation established in a uniform perennial vegetative cover with at least a seventy percent (70%) grass cover. "Final stabilization" also means that no large barren areas exist, and the vegetation is of an equal or better condition than before the project started. The Contractor must remove all temporary erosion and sediment controls once final stabilization is achieved.

PART 21: REDUCED GAS EMISSIONS CREDITS

No one may directly or indirectly use the reduced gas emissions from wells plugged with State of Ohio funds or Infrastructure, Investment and Jobs Act funds, in whole or in part, to monetize, generate, or collect credits to include but not be limited to carbon, methane, or fugitive emissions, or otherwise use the plugging of wells funded with State of Ohio funds or with Infrastructure, Investment and Jobs Act funds to generate income of any type by offsetting their own or another party's gas emissions.



SCOPE OF WORK
ASHTABULA #12 PROJECT
Multiple Orphan Well Sites
Ashtabula County, Monroe & Colebrook Townships

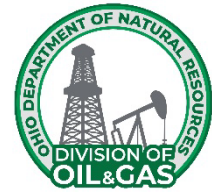

GENERAL SPECIFICATIONS

Unless there is a specific pay item in the Detailed Specifications, the work defined in the General Specification shall be incorporated into other items of work.

PART 1: HOURS OF WORK

The Contractor, the Contractor's agents, representatives, and subcontractors shall perform plugging projects during the days of Monday through Friday. Work will not be conducted on weekends or state/national holidays except with Division approval or during emergency situations. A workday is defined as eight (8) hours. However, additional hours may be worked with Division approval or during emergency situations.

PART 2: EQUIPMENT

The Contractor equipment shall pass all safety requirements of local, state, and federal agencies. The Ohio Department of Natural Resources, Division of Oil and Gas Resources Management reserves the right to inspect the equipment prior to the Recommendation of Award.

Unless otherwise noted, all equipment and materials required to complete the work described shall be provided by the Contractor.

PART 3: NOTIFICATIONS

3.1 Seven Working Day Notice

The Contractor, the Contractor's agents, representatives, subcontractors, or independent contractors shall contact the responsible Division Orphan Well Inspector (the "Inspector") no less than seven (7) working days prior to commencement of work. Notice may be written or oral. This notice will allow the appropriate Division staff time to mark the approved access route and any sensitive areas that need to be left undisturbed.

The Contractor, the Contractor's agents, representatives, and sub-contractors shall contact each utility company that has utilities that directly affect plugging activities at the well location(s).

3.2 Public 48 Hour Notice

Prior to initiating well plugging operations, the Contractor shall give a minimum of 48-hour notice to the local fire department. Confirmation of this notification shall also be made to the Inspector or the Division Regional Office.

3.3 Emergency Notification

When emergency conditions are encountered, such as a release of hydrogen sulfide gas (H₂S), natural gas, crude oil, condensate, or brine that threatens human health, safety or the environment, as described in Ohio Administrative Code 1501:9-08-02, the Contractor shall notify the local fire

department, the Local Emergency Planning Committee (LEPC) and call the 24/7 incident notification number: 1-844-OH-Call1 (1-844-642-2551) within 30 minutes of the occurrence.

3.4 Plugging Completion Notice

No sooner than three business days after emplacing the uppermost plug, the Division will review the well to determine if any additional plugging work shall be required at that time. If additional work is needed, a Field Order will be issued by the Division. The Field Order shall state what must be completed and what, if any, Change Orders shall be required. If additional work is not needed the contractor shall cut the casing as defined in the Plugging Plan and set the plugged well identification as outlined in these **General Specifications** and Ohio Administrative Code 1501-9-11-10.

PART 4: ACCESS AND PRESERVATION OF SITE

All costs for the adequate access to the well site for the plugging equipment shall be included in the Offer. Unless waived, placement of all tanks and equipment shall be subject to Division's approval. If requested by the Division, access roads will be chained or cabled to prevent unauthorized use.

Special attention shall be given to maintaining trees and other vegetation that have scenic value, provide shade, reduce erosion and runoff, or add to the aesthetics of the area. No trees three (3) inches or larger in diameter shall be removed without the Division's permission. Any alterations to the natural topography required to provide ingress and egress to the well site must be approved by the Division before work begins.

PART 5: DAMAGE CAUSED BY CONTRACTOR

All damage caused by the Contractor's negligence in carrying out of this scope of work to any public or private property of any nature whatsoever, including trees, shrubs, and crops, shall be corrected to Division's satisfaction at the expense of the Contractor. If crops are damaged and the Contractor, landowner, or tenant cannot reach a settlement, the County Cooperative Extension Service shall set a fair price for crop damages and the decision shall be final and binding upon all parties. All subsequent payments due the Contractor shall be withheld until the Contractor provides proof of payment of any such claim.

The Contractor shall be responsible for all costs of repairing or replacing any survey monument that is disturbed or destroyed by the Contractor. The Contractor shall utilize a professional surveyor who is licensed and registered by the State of Ohio to perform the re-establishment of said monuments according to the standards set forth by the governing body or law of said monument. For the purpose of this scope of work, the term survey monument shall apply to any property boundary marker, federal, state or county geodetic benchmark, state, or county right of way monument, FEMA benchmarks or flood elevation markers.

PART 6: SAFETY

The following safety protocols shall be completed for each well that is being plugged. The Division, at its discretion, may waive the requirement if all wells in the project are on the same lease/property.

6.1 Public Safety Coordination Meeting

The Contractor shall hold a safety meeting with the local fire department, Division Emergency Operations staff and Inspector, and other applicable contracting staff prior to commencement of plugging activities. The meeting shall review 1) the safety of the public during operations, 2) the safety of workers during operations, 3) emergency notifications of events, 4) site set up and layout, 5) general overview of operations, 6) nearest hospital's address and directions.

6.2 Daily Safety Meetings

The Contractor shall hold a daily safety meeting for all personnel on-site prior to the commencement of work. The Contractor shall provide and maintain a sign in/out sheet for all people on location. The Contractor shall immediately report any accidents and/or safety concerns to the Inspector.

6.3 Operational Standards

The Contractor shall follow the rules established by Occupational Safety and Health Administration (OSHA) Basic Construction Safety 29 CFR 1926 on all onsite project operations.

6.4 Excavation and Trenching Requirements

The Contractor shall follow the notification protocol as specified in Part 3 of the General Specifications before the start of any excavating activities. The Contractor will comply with OSHA Construction Standards for excavation and trenching under 29CFR 1926 Subpart P.

6.5 Hazardous Communications Requirements

The Contractor shall maintain Safety Data Sheets (SDS) for all chemicals stored and/or used on-site. A copy of all SDS will be supplied to the local Fire Department and to the Division.

6.6 Site Security

The Contractor shall provide and install protective barriers/fencing around the work area to prevent unauthorized access. Ingress and Egress access must be maintained at all times.

6.7 Wind Direction Indicator

The Contractor shall install a windsock in an open area of the well location where it is visible to all onsite personnel. It shall be constructed of high visibility material and deployed no less than six (6) feet above grade during the plugging operations.

6.8 Muster and Smoking Areas

The Contractor shall mark and assign a primary and a secondary muster area daily upwind of the well location. These are to be determined based on prevailing wind direction, as indicated by the windsock. The Contractor will post an emergency contact information sheet at each muster site. The Contractor will establish a safe location for a designated smoking area.

6.9 Ignition Sources and Parking Areas

The Contractor shall identify and mark all potential ignition sources within a 50-foot radius of the well. The designated parking area will be outside the 50-foot radius from the well.

6.10 Air Monitoring and Worker Safety

The Contractor shall supply and place a 4-gas monitor at the wellhead. The gas monitor must be calibrated and maintained to monitor Methane (CH₄), Oxygen (O₂), Carbon Monoxide (CO) and Hydrogen Sulfide (H₂S).

Stop work must be followed when any of the levels listed below occur:

- Methane - 1000 parts per million (PPM)/5% Lower Explosive Limit (LEL),
- Oxygen - saturation below 19.5% or above 23%,
- Carbon Monoxide – 50 PPM,
- Hydrogen Sulfide - 10 PPM.

The levels stated above are directly from the Occupational Safety and Health Administration (OSHA) and The National Institute for Occupational Safety and Health (NIOSH) and are standard for air monitoring procedures for safety and work environments. If any of the above levels are alarmed, all personnel will shut down ignition sources and report to the muster area. From the muster area, the Contractor will call 911 for assistance from the local Fire Department.

Division Emergency Operations personnel or the Inspector has the right to stop work if the actions are unsafe or the actions cause or are likely to cause danger to the workers, public, or the environment.

PART 7: MAINTENANCE OF TRAFFIC

The Contractor shall at all times install, maintain, and operate all traffic and traffic control devices in conformance with the requirements of the "Ohio Manual of Uniform Traffic Control Devices for Streets and Highways," hereinafter called The Ohio Manual.

The Contractor shall notify the appropriate public officials and the Division and shall obtain all required permits prior to any lane closure of a public road.

The Contractor shall maintain ingress/egress to all properties associated with the project at all times during the project unless agreed upon in writing by the Division and the landowner.

7.1 STREET CLEANING

The Contractor shall be required to provide street cleaning services in order to remove sediment/debris tracked from the construction site/access drive onto private or public roadways during all phases of the Project.

The Contractor shall work diligently to minimize the amount of sediment tracked onto roadway. The Contractor will conduct all construction and ingress/egress operations in conformance with Part 9: Erosion and Sediment Control of the General Specifications. Use of other erosion and sediment control measures to prevent sediment runoff during period of rains and non-working hours.

The Contractor will provide street cleaning, such as sweeping or vacuuming, at locations around the project ingress/egress where plugging operations has caused tracking of sediments onto roadways. Mechanical sweepers shall be vacuum-type or regenerative sweepers. Sweeping speed will not exceed 6 mph. A minimum of two passes shall be made. Streets must be cleaned daily before the end of the workday. If excess sediments have been tracked onto the streets or if rain is expected, the Division may direct the Contractor to clean the street as often as necessary to keep the street clean at all times.

The Contractor shall be required to remove and dispose of sediments properly. Removal of collected sediment deposits will be disposed on the project site. If sediment deposits cannot be disposed of on-site, an alternative location will be approved by the Division. No offsite disposal will be in or adjacent to a stream and/or floodplain. Sediments to be placed at the project site will

be in conjunction with site restoration and should be spread, compacted, covered, and stabilized in accordance with the site restoration line item. **Sediment will not be allowed to flush into stream or drainage way and washing or flushing of sediments into adjacent drainage systems is prohibited.** If sediment has been contaminated, it will be disposed of in accordance with the contaminated material disposal line item.

The cost of this work shall be included in Contract bid prices for items of which this work is a component.

PART 8: PROTECTION OF EXISTING UTILITIES

Before construction begins, the Contractor, acting as an agent for the Division, shall locate all utilities in the vicinity of the work. The Contractor shall be responsible for complying with the regulations pertaining to utilities in the State of Ohio. The Contractor shall assume all risk for all utilities located in the vicinity of the work, whether above or below the surface of the ground. The Contractor shall also be responsible for all damages and assume all expense for direct or indirect injury, caused by his work, to any of the utilities, or any person or property by reason of injury to them, whether such utilities are or are not shown on the drawings, once they have been uncovered by the work. **In compliance with Ohio Revised Code 3781, two working days before digging the Contractor shall contact the Ohio Utility Protection Service (OUPS) and Oil and Gas Producers Underground Protection Service (OGPUPS) using the Ohio811 one call service by calling 811 or by using the i-dig login found on the internet at OHIO811.org. The Contractor shall maintain a current OUPS/OGPUPS call ticket during the entire project.**

PART 9: EROSION AND SEDIMENT CONTROL

Temporary erosion control measures are required during the course of this project. These measures may consist of the installation of straw bale dikes, silt fence, filter socks, inlet protection structures, erosion control blankets, energy dissipation, and temporary seeding and mulching.

Once construction begins, the Contractor shall be solely responsible for all construction related to the control of off-site sedimentation. This sediment shall be removed by the Contractor at the Division's direction.

9.1 Temporary Measures

Temporary erosion control structures shown on the Drawing Plan Set, identified with these specifications, or as directed by the Division shall be placed as soon as construction starts and must be maintained during the course of the project. At the direction of the Division, the Contractor shall remove the temporary controls when they are no longer needed or when required permanent control measures have been completed.

If sediment escapes the site, accumulations must be removed at a frequency to minimize further negative effects, and whenever feasible, prior to the next rain event.

The contractor shall be responsible for revegetation of all areas in which sediment escapes the site. These areas shall be included in the final stabilization of the project and shall be at the cost of the contractor.

9.2 Maximum Exposed Areas

Stabilization measures must be initiated as soon as practicable in portions of the site where

construction activities have temporarily or permanently ceased, and except as provided below, must be initiated no more than seven (7) days after the construction activity in that portion of the site has temporarily or permanently ceased.

Where the initiation of stabilization measures by the seventh day after construction activity temporarily or permanently ceased is precluded by snow cover, or frozen ground conditions, stabilization measures must be initiated as soon as practicable.

Where construction activity on a portion of the site is temporarily ceased, and earth-disturbing activities will be resumed within fourteen (14) days, temporary stabilization measures do not have to be initiated on that portion of site.

The Division may limit the area of excavation, borrow and embankment operations in progress commensurate with the Contractor's capability and progress in keeping the finished grading, re-soiling, mulching, seeding and other such permanent control measures current in accordance with the acceptable schedule.

9.3 Winterization

When an incomplete project will be left exposed throughout the winter season, the Contractor shall furnish the Division a plan indicating the control measures to be installed and maintained until the next construction season.

If the winter period falls within the anticipated construction period of the Scope of Work and as indicated in the original approved construction schedule, control structures will be paid for by the Division at the unit prices in the Offer.

If the project is not substantially completed prior to the winter season due to the failure of the Contractor to meet the completion date, these necessary control structures will be installed and maintained by the Contractor at his expense and these items will not be paid for under the terms of the Scope of Work, except those that are permanent facilities to be left in place in accordance with the Drawing Plans Set and Specifications.

9.4 Other Controls

Off-site vehicle tracking of sediments and the generation of dust must be minimized, and any waste must be properly disposed.

9.5 Inspections

The Division Inspector shall conduct inspections to ensure that the control practices are functional and to evaluate whether the erosion and sediment control measures are adequate and properly implemented.

9.6 Enforcement

The Division shall take appropriate steps to ensure that sedimentation does not leave the project site. The Division shall require the removal of off-site sediment by the Contractor if such sediment resulted from the Contractor's negligence to place and maintain sediment control structures in accordance with the Drawing Plan Set and Specifications.

PART 10: SPILL PREVENTION AND REMEDIATION

The Contractor is expected to prevent and, if necessary, contain and remediate any spills that may occur at the site due to plugging activities. All stationary plugging equipment on well locations that are in tiled farm fields, residential neighborhoods, parks, or in/adjacent to areas determined by the Division to be environmentally sensitive, will be staged on an impermeable liner and berm. **The Contractor will have oil absorbent pads and booms available onsite during the plugging operations.**

PART 11: HYDROGEN SULFIDE

If the well that is being plugged is known to produce hydrogen sulfide (H₂S), the following considerations must be observed:

- A. The Contractor must provide the appropriate equipment, on-site, to properly detect and abate any H₂S emitted from the well. If the Contractor does not have the appropriate equipment to properly detect and abate any H₂S emitted from the well, they will utilize an appropriate party to provide these services.
- B. The Contractor will shut-in the well each night after the plugging operations have ceased, unless otherwise instructed by the Division. The Contractor will continue this process until the plugging operations are complete and there are no further signs of a gas release.

PART 12: CASING

The Division reserves the right to require the removal and or placement of any tubing, casing, or liners deemed necessary to properly plug and abandon the well. If a string of casing that would normally be pulled cannot be removed, the Contractor may be required to log the well and perforate the casing, in accordance with the Division's instructions, so that cement can be circulated behind the casing.

The Contractor shall run an operational string of casing when caving of the well prevents clean out to depth required in the scope of work.

PART 13: DEFINITIONS

13.1 Clean Out

The process in which the contractor would use a smaller diameter tubular to circulate out material from inside a larger diameter wellbore/tubular. This shall include removing mud-laden fluid, prepared clay, bridge plugs (e.g. brush and stone plugs, surface debris), and wellbore cave-in (e.g. swelling shales, red clays). Equipment needed includes, but is not limited to, tubing, a mud pump, a power swivel/power sub or a tubing swivel, a drill bit with the jets removed and/or a notched collar.

13.2 Drill Out

The process in which the contractor would use a drill string, associated fittings, and a bit to remove an obstruction from inside of the wellbore or casing. This shall include removing cement, grout, wood plugs, or other materials in which a cleanout operation failed to remove. Equipment needed includes, but is not limited to, a mud pump, power swivel/power sub, drill string (including collars and casing or tubing), cross over subs, bit sub, and drill bit.

13.3 Wash Over

A process in which the contractor would use an intermediate size working string of casing, usually equipped with a carbide coated collar on the bottom joint, to run down over the smaller well tubular and clean out the annular space between the well tubulars. This process would include utilizing a power swivel or power sub to rotate the working string of casing and a mud pump to circulate fluid down between the working string and the outside of the smaller well tubular to wash out the material in the annular space between the well tubulars. This shall include removing mud-laden fluid, prepared clay, cement, grout, field packers, and surface debris. When needed, a wash over bit shall be attached on the bottom of the larger casing to act as a cutting edge for the material on the backside of the tubular being washed over.

13.4 Milling

The process in which the contractor shall use a drill string and bit to remove a metal obstruction from inside of the wellbore or casing. Equipment needed includes, but is not limited to, a **positive displacement mud pump with the capacity of pumping at least 3 barrels per minute and able to overcome hydrostatic head**, power swivel/power sub, drill string (includes collars and casing or tubing), cross over subs, bit sub, and mill. The mill type would depend on the material encountered.

13.5 Fishing

The process in which the contractor shall use a specialized tools or fishing tool to eliminate an obstruction from inside of the wellbore or casing. Equipment needed includes, but is not limited to, a fishing tool(s) and fishing string.

13.6 Bail & Grout

The process the contractor shall use when determined that the wellbore can be bailed of all fluid, and grouted. Equipment needed includes, but is not limited to, tubing, a bailer, and a grout pump. Grout shall be gravity feed to the bottom. This can be done in one application or in stages, depending on the well depth and condition. If the well cannot be bailed completely dry the contractor shall use a siphon string/tremie tube to remove the water from the well during grout application.

PART 14: WELL OBSTRUCTION ASSESSMENT

If an obstruction is encountered in the well bore that prevents the Contractor from reaching total depth, the Contractor will attempt to identify/assess the nature of the obstruction and attempt to remove any obstruction deemed an impediment to the plugging operation. **The Contractor will supply impression blocks as part of their normal rig equipment.**

PART 15: REMOVAL OF AN OBSTRUCTION

The removal of an unknown obstruction that is encountered during the cleanout of a well may require the use of milling and/or fishing tooling and equipment. The Contractor will include the costs for these services on the appropriate line items in the contingency section of this offer unless these costs are part of a planned procedure. The Division will approve a method for the Contractor to remove the well obstruction. The Division will first utilize contingency specifications and line items to define this work. **The Division will**

not be responsible for milling or fishing charges that are due to Contractor negligence or Contractor equipment failure.

PART 16: PLUGGED WELL IDENTIFICATION

In compliance with Ohio Administrative Code 1501:9-11-10, a steel plate, a minimum of ¼-inch thick, shall be tack welded on top of all plugged wells. The well's permit number and "ODNR" shall be welded on the plate in numbers/letters as large as practical. Letters shall have a minimum relief of 1/8-inch.

PART 17: TOILET FACILITIES

Where there are no readily accessible public toilet facilities, the Contractor will provide a portable field toilet on the location during plugging operations.

PART 18: COMPLETION, GUARANTEES AND WARRANTIES

Upon completion of the work described in the Project SOW, the Contractor shall request a Project Completion Inspection be performed by the Division. The Division shall inspect the Project site(s) for completeness and acceptance against the Project SOW, and if the Division determines necessary, develop a list of incomplete and unacceptable work and conditions to be corrected by the Contractor. The Division will reinspect the Project site(s) until the Division determines all work described in the Project SOW is complete and acceptable.

The Contractor warrants (represents) that their work will be conducted in accordance with the standards described in the Project SOW (i.e., the SOW Detailed Drawings and Specifications) and that the Contractor's work be free of defects. Contractor guarantees their work and materials for a Warranty Period of one year, unless otherwise stated as a special provision of the SOW Detailed Specifications. The one-year Warranty Period commences on the date of inspection on the Project Completion Inspection form that accepted the work.

Should defects develop with the Contractor's work or materials within the Warranty Period, the Contractor shall, upon written notice of the Division, remedy the defects and any associated disturbance at their own expense. If the Contractor, after receiving the Division's notice, does not remedy the defects to the satisfaction of the Division, the Division may proceed against the Contractor as prescribed by the Department of Administrative Services (DAS), Index Number MAC110. All representations, warranties, and guarantees made in the DAS Index Number MAC110 contract and the Project SOW shall survive final payment and termination or completion of this Contract.



SCOPE OF WORK
ASHTABULA #12 PROJECT
Multiple Orphan Well Sites
Ashtabula County, Monroe & Colebrook Townships

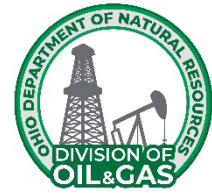

SEQUENCE OF WORK

General: Performance of all work shall be coordinated with the Division of Oil and Gas Resources Management (“Division”) Orphan Well Inspector (“Inspector”). The Sequence of Work shall be repeatable for all the project’s wells. **Work ahead of service rig mobilization shall be at the discretion of the Division.** Work shall not be initiated prior to fourteen (14) days ahead of rig mobilization, **unless approved in writing by the Division.** Any work performed shall be done in accordance with all requirements listed in this Scope of Work.

The Sequence of Work for the Orphan Well Project shall be as follows:

Phase I:

- 1) Contact the Ohio Utility Protection Service and the Ohio Oil & Gas Producers Underground Protection Service.
- 2) Coordinate with the Orphan Well Inspector and the local authorities for the mobilization of equipment over the roads and bridges to the site as applicable.
- 3) Verify with the Orphan Well Inspector that the pre-construction staking (i.e. Construction Work Limits) has been completed by the Division. **The pre-construction staking must be completed prior to mobilization.**

Phase II:

- 1) Mobilize all necessary equipment to the site and develop the site access as shown on the **Drawing Plan Set.**
- 2) Implement site safety and secondary containment as described in the **Detailed Specifications.**
- 3) Install perimeter sediment controls as required by the Division.
- 4) Prepare the well for plugging as described in the **Detailed Specifications, “Well Head Control.”**
- 5) Upon successful installation and approval of the wellhead and establishment of well control, the Contractor shall begin to plug the well as described in the **Plugging Plan and Detailed Specifications, “Well Preparation & Plugging.”**
- 6) **No sooner than three (3) business days after placing the uppermost plug, the Division will inspect the well at surface to determine if any additional plugging work shall be required at that time. If additional work is not needed the Contractor shall cut the casing as defined in the Plugging Plan.**

- 7) The Contractor shall set the plugged well identification as outlined in the **General Specifications** and Ohio Administrative Code 1501-9-11-10.

Phase III:

- 1) Within three (3) working days after Division has determined the plugging operations are completed, the Contractor shall remove all well and well plugging-related equipment, fluids, and cuttings from the site. The Contractor shall also excavate and remove all contaminated soils present onsite if present.
- 2) Within fourteen (14) days after the completion of the plugging operations, the Contractor shall reseed as applicable, final grade, disc, fertilize, seed, and mulch all disturbed areas. **If work cannot be complete due to the season or weather conditions, the site shall be winterized per the General Specifications, Part 9 Erosion and Sediment Control and the site restoration shall be scheduled for completion.**
- 3) All reclamation shall be finished to an equal or better condition than what existed prior to construction. The Division shall give the final approval for the restoration of the site.



SCOPE OF WORK
ASHTABULA #12 PROJECT
Multiple Orphan Well Sites
Ashtabula County, Monroe & Colebrook Townships

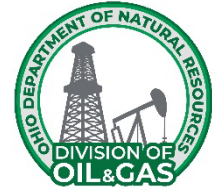

WELL DESCRIPTION

This Well Description is for:

John Pazdziorko #1, API #34-007-2-0034-00-00, Ashtabula County, Monroe Township.

Background: The John Pazdziorko #1 is located 4.75 miles east of Kingsville within a wooded area approximately 520 feet south of Weaver Road. The 7.54-acre parcel (#32-009-00-012-01) is owned by Terry A. Palmer.

Recent Division inspections show that well is equipped with 10.75-inch casing, 5.5-inch casing and 2-inch tubing. The tubing is open above a closed gate valve. There is a tubing head on the 5.5-inch casing with 3.5-inch steel lines tied into it with closed gate valves. The 5.5-inch casing is on a hanger that is resting on the 10.75-inch casing. There is no storage equipment associated with this well.

According to the Geological Survey Well Card on file, the John Pazdziorko #1 was drilled in 1959 to a total depth of 3,145 feet to produce from the Clinton Sandstone. The record shows the following formation information:

Formation	Top (ft)	Bottom (ft)	Remarks
Shale & gravel	0	90	Water at 90 feet
Shale & slate	90	365	
Slate	365	1,000	
Shale	1,000	1,330	
Slate	1,330	1,605	
Shale	1,605	1,690	
Slate, gray	1,690	1,807	
Slate, black	1,807	1,835	
Lime	1,835	2,010	
Oriskany	2,010	2,170	Hole full of water at 2,148 feet
Newburg	2,870	2,935	Hole full of water at 2,885 feet
Bottom lime		2,960	
Shale	2,960	2,987	
Lime	2,987	2,992	
Slate	2,992	3,040	
Little lime	3,040	3,070	
Slate	3,070	3,079	
Red rock	3,079	3,087	
Stray	3,087	3,106	
White Clinton	3,106	3,116	

Sand broken	3,116	3,124	
Sand dark	3,124	3,130	
Red sand	3,130	3,142	
White sand	3,142	3,145	

The completion data for the John Pazdziorko #1 shows the following casing information:

- 10.75-inch diameter casing set to 78 feet
- 8-inch diameter casing set to 365 feet
- 7-inch diameter casing set to 2,342 feet, removed upon completion
- 5-inch diameter casing set to 3,082 feet, cemented
- 2-inch tubing set to 3,140 feet

For the purposes of this Scope of Work it is assumed that the John Pazdziorko #1 was drilled to a total depth of 3,145 feet into the Clinton Sandstone, that it is equipped with 78 feet of 10.75-inch casing, that it is equipped with 365 feet of 8-inch casing, that it is equipped with 3,082 feet of cemented 5.5-inch diameter casing, that it is equipped with 3,140 feet of 2-inch tubing, and that it is unknown if there is pressure on the well.

The deepest underground source of drinking water (USDW) is not mapped in this area. Based on local water well data, offset oil and gas well records within the reviewed area, and published groundwater resources information for Ashtabula County, water wells in this area are developed within interbedded sand and gravel deposits and may yield up to ten gallons per minute. There are no documented water wells within 300 feet of the John Pazdziorko #1. The work zone does not fall within any source water protection areas. According to the Division of Mineral Resources Management, there are no documented underground or surface mines at the well location.

Scope of Work: This project includes the mobilization and access to the site, plugging the orphan well, removal of all oil field equipment, temporary storage and disposal of all fluid and materials removed from the well and well site and regrading and revegetating all areas disturbed by the plugging operation.

It is the Contractor's responsibility to contact all County, Township, State and Municipal Officials having jurisdiction over all roads that are intended to be utilized for this project. The Contractor shall provide written documentation to the Chief, of all road use notifications/approvals prior to mobilizing equipment to the site.



SCOPE OF WORK
ASHTABULA #12 PROJECT
Multiple Orphan Well Sites
Ashtabula County, Monroe & Colebrook Townships

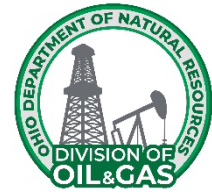

PLUGGING PLAN

This Plugging Plan is for:

John Pazdziorko #1, API #34-007-2-0034-00-00, Ashtabula County, Monroe Township.

For the purposes of this Scope of Work it is assumed that the John Pazdziorko #1 was drilled to a total depth of 3,145 feet into the Clinton Sandstone, that it is equipped with 78 feet of 10.75-inch casing, that it is equipped with 365 feet of 8-inch casing, that it is equipped with 3,082 feet of cemented 5.5-inch diameter casing, that it is equipped with 3,140 feet of 2-inch tubing, and that it is unknown if there is pressure on the well. Further detailing of the Plugging Plan requirements can be found in the Detailed Specifications. Photos are provided in Appendix II.

- 1) The Contractor will safely relieve any pressure that may be built up on this well prior to commencing plugging operations. The Contractor will give the property owner and local fire authorities a minimum of twenty-four (24) hour notice prior to blowing down the well.
- 2) The Contractor shall visually examine the existing casing(s), to evaluate their condition immediately below grade. If the casing(s) are found to be severely degraded, the Contractor will remove the incompetent section of casing and install enough new casing, of similar diameter, to bring the top of the existing casing(s) to a suitable working height.
- 3) The Contractor shall install an appropriately sized and lined temporary cellar around the wellhead to capture any fluids generated during the plugging process.
- 4) The Contractor shall then install an appropriate wellhead and an approved method of well control on the most appropriate sized casing to insure there is control of gas and/or fluids generated from the well. **The Contractor shall establish and maintain well control throughout the entire plugging process** and maintain 200 barrels of freshwater on location for well control.
- 5) The Contractor will remove the 2-inch tubing and stage it on a bermed liner for further evaluation. The Contractor shall provide an accurate measurement of the amount of tubing retrieved from the wellbore.
- 6) Once the tubing is removed, the Contractor will run their tools down the well to verify the well is open to 3,140 feet or a depth approved by the Division.
- 7) Once total depth or a Division approved depth has been verified, the Contractor will load the hole with freshwater and run a Gamma Ray/CCL/Temperature/Bond & Caliper log to verify casing diameter, depth of casing, borehole diameter, and any bond behind casings that are present.
- 8) All cement plugs shall be set through a working string of 1.5-inch minimum inside diameter (ID) tubing using an approved cement with 2% Calcium Chloride, mixed at 15.6 pounds per gallon. **The well shall be in a static condition prior to beginning any cementing activities.** In addition, at the

discretion of the Division, circulation must be established, and all free crude oil shall be circulated from the wellbore prior to setting any plug.

- 9) The Contactor will set a 450-foot bottom plug from 3,140 feet to 2,690 feet to cover the Clinton Sandstone. The Contractor will wait on cement a minimum of eight (8) hours, after which they will run their tools into the hole to verify the depth to the top of the plug. If the plug level has dropped or it is determined that a competent plug has not been achieved, additional plugs may be required, at the discretion of the Division.
- 10) The Contractor will then rip/shoot the 5.5-inch diameter casing at the lowest free point above the salt section, which will be determined by log data (estimated to be at 2,400 feet) and remove it from the wellbore. All casing removed from the well will be staged on a bermed liner for further evaluation. The Contractor will provide accurate measurements for casing retrieved from the wellbore.
- 11) The Contactor will set a 400-foot plug from 2,175 feet to 1,775 feet to cover the top of the Big Lime. The Contractor will wait on cement a minimum of eight (8) hours, after which they will run their tools into the hole to verify the depth to the top of the plug. If the plug level has dropped or it is determined that a competent plug has not been achieved, additional plugs may be required, at the discretion of the Division.
- 12) At the discretion of the division, the Contactor will set a 400-foot plug from 1,100 feet to 700 feet to cover a potential production zone in the Ohio Shale. The Contractor will wait on cement a minimum of eight (8) hours, after which they will run their tools into the hole to verify the depth to the top of the plug. If the plug level has dropped or it is determined that a competent plug has not been achieved, additional plugs may be required, at the discretion of the Division.
- 13) The Contactor will set a 350-foot plug from 550 feet to 200 feet. The Contractor will wait on cement a minimum of eight (8) hours, after which they will run their tools into the hole to verify the depth to the top of the plug. If the plug level has dropped or it is determined that a competent plug has not been achieved, additional plugs may be required, at the discretion of the Division.
- 14) The Contactor will set a surface plug from the top of the previous plug to within 30-inches of ground level, wait on cement a minimum of eight (8) hours, then check the cement level and top off with additional cement if necessary.
- 15) No sooner than three (3) business days after placing the uppermost plug, the Division will inspect the well at the surface to determine if any additional plugging work shall be required at that time. If additional work is not needed the Contractor shall cut to a depth of 30-inches below grade, and the Contractor shall set the plugged well identification as outlined in the General Specifications and Ohio Administrative Code 1501-9-11-10.



SCOPE OF WORK
ASHTABULA #12 PROJECT
Multiple Orphan Well Sites
Ashtabula County, Monroe & Colebrook Townships

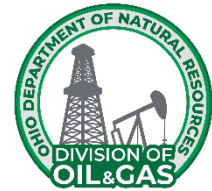

WELL DESCRIPTION

This Well Description is for:

JA Zevchik Unit #1, API #34-007-2-1658-00-00, Ashtabula County, Colebrook Township.

Background: The JA Zevchik Unit #1 is located 3.2 miles east of Orwell within a field approximately 325 feet east of Fenton Road. The 14.26-acre parcel (#10-016-00-010-03) is owned by Nathan and Rudy Miller.

Recent Division inspections show that well consists of 4.5-inch casing swaged down to 2-inch that has been bent over at ground level. The top of the swage is open. No production, transmission, or storage equipment was found to be associated with this well.

According to the Geological Survey Well Card on file, the JA Zevchik Unit #1 was drilled in 1981 to a total depth of 3,840 feet to the Queenston and was completed to produce from the Clinton Sandstone. The record shows the following formation information:

Formation	Top (ft)	Bottom (ft)	Remarks
Ohio shale		2,088	
Big Lime	2,088	2,650	
Salt	2,650	3,154	
Lockport	3,154	3,584	
Packer shale	3,584	3,620	
Clinton	3,620	3,800	
Queenston	3,800	3,840	Total depth

The completion data for the JA Zevchik Unit #1 shows the following casing information:

- 8.63-inch diameter casing set to 300 feet and cemented to surface with 150 sacks
- 4.5-inch diameter casing set to 3,827 feet and cemented with 150 sacks

The 4.5-inch casing was shot 19 times between 3,664 feet and 3,740 feet.

For the purposes of this Scope of Work it is assumed that the JA Zevchik Unit #1 was drilled to a total depth of 3,840 feet into the Queenston formation, that it is equipped with 300 feet of cemented 8.63-inch surface casing, that it is equipped with 3,827 feet of 4.5-inch casing cemented with 150 sacks, and that the 4.5-inch casing is open at the surface and bent over.

The deepest underground source of drinking water (USDW) is not mapped in this area. Based on local water well data, offset oil and gas well records within the reviewed area, and published groundwater resources information for Ashtabula County, water wells in this area are developed in clay, sandy clay, or underlying shale. Many water wells are dry or brackish and typically yield less than three gallons per

minute. There are no documented water wells within 300 feet of the JA Zevchik Unit #1. The work zone does not fall within any source water protection areas. According to the Division of Mineral Resources Management, there are no documented underground or surface mines at the well location.

Scope of Work: This project includes the mobilization and access to the site, plugging the orphan well, removal of all oil field equipment, temporary storage and disposal of all fluid and materials removed from the well and well site and regrading and revegetating all areas disturbed by the plugging operation.

It is the Contractor's responsibility to contact all County, Township, State and Municipal Officials having jurisdiction over all roads that are intended to be utilized for this project. The Contractor shall provide written documentation to the Chief, of all road use notifications/approvals prior to mobilizing equipment to the site.



SCOPE OF WORK
ASHTABULA #12 PROJECT
Multiple Orphan Well Sites
Ashtabula County, Monroe & Colebrook Townships

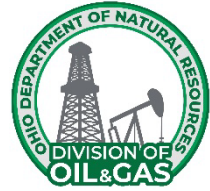

PLUGGING PLAN

This Plugging Plan is for:

JA Zevchik Unit #1, API #34-007-2-1658-00-00, Ashtabula County, Colebrook Township.

For the purposes of this Scope of Work it is assumed that the JA Zevchik Unit #1 was drilled to a total depth of 3,840 feet into the Queenston formation, that it is equipped with 300 feet of cemented 8.63-inch surface casing, that it is equipped with 3,827 feet of 4.5-inch casing cemented with 150 sacks, and that the 4.5-inch casing is open at the surface and bent over. Further detailing of the Plugging Plan requirements can be found in the Detailed Specifications. Photos are provided in Appendix II.

- 1) The Contractor shall visually examine the existing casing(s), to evaluate their condition immediately below grade. If the casing(s) are found to be severely degraded, the Contractor will remove the incompetent section of casing and install enough new casing, of similar diameter, to bring the top of the existing casing(s) to a suitable working height.
- 2) The Contractor shall install an appropriately sized and lined temporary cellar around the wellhead to capture any fluids generated during the plugging process.
- 3) The Contractor shall then install an appropriate wellhead and an approved method of well control on the most appropriate sized casing to insure there is control of gas and/or fluids generated from the well. **The Contractor shall establish and maintain well control throughout the entire plugging process** and maintain 200 barrels of freshwater on location for well control.
- 4) The Contractor will run their tools down the well to verify the well is open to 3,820 feet or a depth approved by the Division. If the well is not open, the Contractor will drill/clean out the well to 3,820 feet or a depth approved by the Division.
- 5) Once total depth or a Division approved depth has been verified, the Contractor will load the hole with freshwater and run a Gamma Ray/CCL/Temperature/Bond & Caliper log to verify casing diameter, depth of casing, borehole diameter, and any bond behind casings that are present.
- 6) All cement plugs shall be set through a working string of 1.5-inch minimum inside diameter (ID) tubing using an approved cement with 2% Calcium Chloride, mixed at 15.6 pounds per gallon. **The well shall be in a static condition prior to beginning any cementing activities.** In addition, at the discretion of the Division, circulation must be established, and all free crude oil shall be circulated from the wellbore prior to setting any plug.
- 7) The Contractor will set a 450-foot bottom plug from 3,800 feet to 3,350 feet to cover the Clinton Sandstone. The Contractor will wait on cement a minimum of eight (8) hours, after which they will run their tools into the hole to verify the depth to the top of the plug. If the plug level has dropped or it is determined that a competent plug has not been achieved, additional plugs may be required, at the discretion of the Division.

- 8) The Contractor will then rip/shoot the 4.5-inch diameter casing at the lowest free point above the salt section, which will be determined by log data (estimated to be at 2,600 feet) and remove it from the wellbore. All casing removed from the well will be staged on a bermed liner for further evaluation. The Contractor will provide accurate measurements for casing retrieved from the wellbore.
- 9) The Contractor will set a 400-foot plug from 2,380 feet to 2,030 feet to cover the top of the Big Lime. The Contractor will wait on cement a minimum of eight (8) hours, after which they will run their tools into the hole to verify the depth to the top of the plug. If the plug level has dropped or it is determined that a competent plug has not been achieved, additional plugs may be required, at the discretion of the Division.
- 10) The Contractor will set a 400-foot plug from 1,300 feet to 900 feet to cover a potential production zone in the Ohio Shale. The Contractor will wait on cement a minimum of eight (8) hours, after which they will run their tools into the hole to verify the depth to the top of the plug. If the plug level has dropped or it is determined that a competent plug has not been achieved, additional plugs may be required, at the discretion of the Division.
- 11) The Contractor will set a 300-foot plug from 500 feet to 200 feet to cover the bottom of the surface casing. The Contractor will wait on cement a minimum of eight (8) hours, after which they will run their tools into the hole to verify the depth to the top of the plug. If the plug level has dropped or it is determined that a competent plug has not been achieved, additional plugs may be required, at the discretion of the Division.
- 12) The Contractor will set a surface plug from the top of the previous plug to within 30-inches of ground level, wait on cement a minimum of eight (8) hours, then check the cement level and top off with additional cement if necessary.
- 13) No sooner than three (3) business days after placing the uppermost plug, the Division will inspect the well at the surface to determine if any additional plugging work shall be required at that time. If additional work is not needed the Contractor shall cut to a depth of 30-inches below grade, and the Contractor shall set the plugged well identification as outlined in the General Specifications and Ohio Administrative Code 1501-9-11-10.



SCOPE OF WORK
ASHTABULA #12 PROJECT
Multiple Orphan Well Sites
Ashtabula County, Monroe & Colebrook Townships

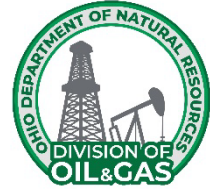

DETAILED SPECIFICATIONS

The Contractor is reminded to review the Scope of Work documents carefully. Coordination, permission, or direction of the Division may be required for use of individual Detailed Specification line items. The Division shall only pay for quantities of items that are correctly installed and completed in accordance with the Detailed Specifications and Drawing Plan Set. The Division shall not guarantee payment of any work completed without or prior to following the conditions described herein of each line item.

MOBILIZATION

- A. Description: This work shall consist of the development of access and the mobilization of the Contractor's forces and equipment necessary for performing the required work under the Scope of Work for the well site.

This item shall include the transportation of personnel, equipment, and supplies to and from each site as well as the maintenance of all onsite access roads.

As part of this line item, the Contractor shall also include any maintenance of traffic required within the road right-of-way per Part 7 of the General Specifications.

Also, the Contractor shall be responsible for cleaning mud and dirt associated with construction from all roadway surfaces (public and private) as per Part 7.1 of the General Specification for the duration of the Project and as directed by the Division.

- B. Execution: No additional compensation shall be made to the Contractor for remobilization after his equipment has been removed from the site. If applicable, this shall include remobilization of equipment if removed due to winterization of the project.

Any damage to the road, drives, and/or culverts caused by the mobilization shall be repaired by the Contractor at the Contractor's expense. All repairs shall be done equal to or better to that which existed prior to construction activities.

Crop removal shall be considered incidental to "**Mobilization**".

- C. Measurement: Measurement for payment will be considered and measured as a unit satisfactorily completed and accepted by the Division.

If any portion of the item is non-performed to the satisfaction of the Division (i.e., the mud and dirt are not cleaned from the roadway, the proper signage is not used as detailed) this is considered unsatisfactory and shall be cause for the rejection of payment of this item.

As part of the consideration to be satisfactorily completed, work shall be per the "Sequence of Work."

- D. Payment: The cost of this work shall be included in the lump sum price for "**Mobilization.**"

CLEARING & GRUBBING

- A. Description: This item covers the removal of the vegetation within the limits shown on the Drawing Plan Set to provide adequate space to maneuver equipment to complete the proposed work at each well.
- B. Execution: The Contractor shall only clear enough of the site within the limits shown on the Drawing Plan Set to provide adequate space to maneuver equipment to complete the proposed work. The Division shall exercise control over clearing and shall designate all trees, plants, shrubs, abandoned material, trash, etc., to be removed or to remain. This work shall also include the preservation from injury or defacement of all trees designated to remain.

If the Contractor clears and/or grubs beyond the construction work limits, whether knowingly or accidentally, the Contractor shall replant and/or otherwise restore all areas outside of the limits to a condition equal to or better than what existed prior to beginning work. This shall be no at no additional expense to the Division.

All tree disturbance (trimming and/or removal) activities shall be coordinated with the Division as these trees may provide suitable roosting, foraging, or traveling habitat for Threatened & Endangered species. To prevent adverse impacts to Threatened & Endangered species, clearing of trees with a DBH (Diameter at Breast Height) greater than 3 inches, **shall not take place between April 1st and September 30th.**

All removed vegetation shall be placed in a stable manner. **Brush and debris shall be stacked to the down slope side of the work, outside of the work limits.** The Division shall make the final determination as to the stability and location of the constructed piles. The log pile(s) shall not exceed four (4) feet in height or eight (8) feet in width, and thirty (30) feet in length. The Contractor shall be responsible for the repair/reconstruction of the piles, at the discretion of the Division, up to the final acceptance of the project.

All stumps shall be cut off flush with the existing ground surface prior to placement of material.

All logs and stumps not suitable for stacking onsite shall be hauled off site. Proper disposal is the Contractor's responsibility. If necessary, logs/vegetation shall be hauled to an authorized OEPA landfill.

Burning of debris materials shall not be permitted on-site.

- C. Measurement: Measurement for payment will be considered and measured as a unit satisfactorily completed and accepted by the Division. This measurement shall be for the entire project as one unit.
- D. Payment: Payment shall be made at the contract lump sum price per "**Clearing & Grubbing.**"

SITE SAFETY

- A. Description: The work will include the installation and implementation of safety procedures for the plugging of the orphan well as described herein.

- B. **Definitions & Installation:** It is the Contractor's responsibility to properly maintain all of the latter mentioned throughout the duration of the project. Any damages shall be repaired or replaced at no additional cost to the Division. Site safety measures shall be removed prior to the demobilization of the Contractor's workforces.

Any release of materials into or onto the ground or surface waters outside of the primary and/or secondary containment shall follow the Ohio One-Call System as described in Appendix I, "One Call". The Ohio One-Call System shall be contacted at 1-844-OHCALL1 within 30-minutes of becoming aware of the occurrence.

1. **Notification:** Due to the close proximity of the wells to residences, buildings and the potential safety issues involved with the plugging procedure, the contractor or contractor's representative will contact the residents two weeks prior to the commencement of plugging activities to notify them of the potential safety issues.
2. **Temporary Construction Fence & Posts:** The temporary construction fencing shall be composite, orange mesh with a minimum overall height of four (4) feet. Fence posts are to be steel five (5) feet t-posts. Fence materials shall meet the ODOT Construction and Materials Specifications (CMS) Item 710.11.

The posts shall be driven or set in holes to a minimum depth of one (1) foot and at intervals not to exceed ten (10) feet. The fence shall be stretched and securely fastened to each post using metal or plastic ties.

Fencing shall be placed around the entire work area. The Contractor shall work in conjunction with the Division for placement of the temporary fence. All fence shall be removed at the completion of the project.

3. **Identifications & Markings:** Any potential ignition sources within a fifty (50) foot radius shall be identified and marked by the Contractor.

All identifications, marking and plugs shall be inspected and approved by the Division prior to commencing with any well plugging activities.

4. **Air Movers (Industrial Fans):** The Contractor will also be required to have onsite industrial fans or air movers in the event natural gas is detected and found to be settling at ground level and not properly dissipating from the site.
5. **Temporary Shut-In:** The Contractor will shut-in the well each night after the plugging operations have ceased, unless otherwise instructed by the Division. The Contractor will continue this process until the plugging operations are complete and there are no further signs of a gas release.
6. **Power/Utility Lines Safety:** Other utility lines also cross the work area which will also need to be worked around to ensure no damage is caused to the lines.

Utility lines cross over the access route which will require warning signs to insure awareness.

7. **Emergency Response Plan:** The Contractor will assemble an Emergency Response Plan (ERP) with all contact information, emergency preventative measures, and for any well-related issues that may occur. ERPs shall be submitted to the Division via email to DOGARM.EMNOTIFY@dnr.ohio.gov for approval prior to beginning work.

The Contractor will be responsible for maintaining this ERP on site during the plugging operations. Ingress/Egress for evacuation and/or public safety will be discussed in the safety meeting to be held on location by the Contractor with local responders and Division personnel. These routes will be listed in the ERP. The Division will review with the Contractor prior to the start of plugging operations.

Well Name	Safety Measures Required
John Pazdziorko #1, JA Zevchik Unit #1	Notification; Temporary Construction Fence & Posts; Identifications & Markings; Air Movers; Temporary Shut-In; Power/Utility Lines Safety; Emergency Response Plan

- C. Measurement: Measurement for payment will be considered and measured as a unit satisfactorily completed and accepted by the Division.
- D. Payment: Payment for this work, including labor, installation, materials and removal shall be made at the lump sum price for "Site Safety."

ROAD MATS

- A. Description: This item shall consist of the transportation, delivery, installation, and removal of road mats as described. The placement of road mats within the limits of construction shall be at the discretion of the Division. This item shall be utilized to protect the existing utilities, driveways, roadway, curbs, sidewalks, and lawn space that will be traversed within the construction work limits. This item shall also include all work required to move between wells included in this contract, that require road mats as shown on the Drawing Plan Set.
- B. Material: Road matting shall be non-permeable, composite mats. Non-permeable, composite mats shall be a minimum of four (4) inches thick with a minimum surface dimension of seven (7) feet wide and thirteen (13) feet long. Non-permeable, composite mats and associated components (i.e. ramps, berms, and fittings) shall be installed per the manufacturer’s recommendations.

All materials delivered to the site must be in a shape to be able to cover the area properly and still have the strength and integrity to complete the required work. The Division may reject any mats determined to be damaged beyond useful life or remove square footage as measured from each individual mat.

- C. Execution: Mats shall be kept clean throughout the project. If it is determined by the Division, the mats do not meet this requirement the Contractor shall have any sediment or mud removed immediately.
- D. Measurement: Measurement for payment for the road mats shall be made by actual field measurements of quantities satisfactorily installed at the site. Each road mat shall be measured for a square foot installed.

Road mats shall be utilized for the duration required to plug the well at each site. Only one measurement and payment shall be made for “Road Mats” upon completion of the well site.

For circumstances in which the Division extends the projected completion date (i.e. well obstructions, required milling operations, etc.), the contractor shall also provide a cost for "Road Mats" as a dollar amount per mat per day under “Contingency Specifications” within

the original Offer. Additional payment will be evaluated and determined by the Division.

- E. Payment: The cost of this work shall be included in the unit price per square foot for "**Road Mats.**"

SECONDARY CONTAINMENT

- A. Description: This item shall include all labor and materials required for the installation, maintenance, and deconstruction of the secondary containment. Onsite materials and equipment required to be stored within the secondary containment shall be as follows: containers that store liquid brine, oilfield waste, and/or fuels as well as any required pumps. In determining the method, design, and capacity for secondary containment, the Contractor shall address the typical failure mode, and the most likely quantity of brine or other oil field waste substance that would be discharged.
- B. Materials: The Contractor shall supply catchment basins or diversion structures to intercept and contain discharges of brine or other oilfield waste substances during the project. Materials shall consist of impermeable containers or liners made of a material that is compatible with the waste stored or used within the containment. Containment materials shall be impervious and have supporting documentation of the permeability, chemical compatibility, and other applicable QA/QC standards, is acceptable. **Use of a liner shall at a minimum be a 20-mil thickness.**

Materials shall be durable enough to support the weight of heavy equipment used for the plugging operations. Materials shall have sufficient strength and thickness to maintain the integrity of the container or liner. The container or liner shall be designed, constructed, and maintained so that the physical and chemical characteristics of the container or liner are not adversely affected by the waste and the container or liner is resistant to physical, chemical and other failure during transportation, handling, installation and use.

Liner walls shall consist of metal, wood, concrete, plastic, or approved equal. Wall materials shall be designed, constructed, and maintained to withstand the overtopping and sliding forces of secondary containment filled to capacity.

The Division shall determine the merit of the proposed materials compatibility, impermeability, integrity, and durability in determining if the material is sufficient for the project.

- C. Installation: Secondary containment shall be installed prior to any drilling or liquid storage at the project site. **Secondary containment shall provide a minimum volume equal to 50% of the primary storage capacity.**

Upon request of the Division, the Contractor shall provide calculations in tabular format of the containment providing both the secondary containment capacity and the on-site material storage. The Division can require that sections of a secondary containment be removed for inspection and sampling if a spill occurs during the project.

Installation of the containers or liners, including seams and pipe penetrations, shall be in accordance with the manufacturer's recommendations. All seams and non-seam area of the container or liner shall be inspected by the Division for defects, holes, and blisters.

Care shall be taken when operating equipment on or near the container or liner to prevent any damage to the secondary containment. If damage occurs, it shall be repaired by the Contractor at

his/her expense prior to continuing the project.

The Contractor shall retain all ownership and responsibility for the secondary containment. All secondary containment shall be removed from the site and retained by the Contractor at the conclusion of the project.

- D. Measurement: Secondary containment, which includes all materials, labor, and equipment necessary to provide the required secondary containment, will be considered and measured as a unit satisfactorily completed and accepted by the Division. Secondary containment shall not be considered complete until all secondary containment has been removed from the site at the completion of the project.
- E. Payment: Payment for this work shall include all material, labor, and equipment necessary to complete the work and be made at the lump sum price for "**Secondary Containment.**"

SILT FENCE

- A. General: This item covers construction of the silt fences and/or straw bale dikes. The Division shall designate utilization of silt fence, straw bale dikes or a combination of both at locations selected for placement.

The placement of silt fence and straw bale dikes within the limits of construction shall be at the discretion of the Division.

During the life of the project, the Contractor shall maintain these silt and erosion-control structures. Accumulated silt shall be removed when it, in the Division's opinion, may damage or reduce the effectiveness of the structure.

- B. Straw Bale Dikes

1. Materials: Straw bale dikes shall be constructed with twine-bound square straw or hay bales, staked to remain in place.
2. Installation and Execution: The location of the dikes shall be as directed by the Division, at the time of construction. When the usefulness of the dikes has ended, they shall be removed and disposed. Dikes may remain in place upon completion of the project only when permitted by the Division.

- C. Silt Fence

1. Materials

- a. The silt fence fabric shall conform to the ODOT Item 712.09, Type C. The silt fence shall be installed in accordance with all manufacturers' instructions.

The fabric shall be free of any treatment that might significantly alter its physical properties. During shipment and storage, the fabric shall be wrapped in a heavy-duty protective covering to protect it from direct sunlight, dirt, and other debris.

The manufacturer shall submit certified test data to cover each shipment of material.

- b. The silt fence used shall be a prefabricated silt fence with fabric already attached to posts or shall be assembled in the field according to the following installation guidelines.

The fabric shall be a pervious sheet composed of a strong, rot-proof polymeric yard or fiber oriented into a stable network, which retains its relative structure during handling, placement, and long-term service. It shall have excellent resistance to deterioration from ambient temperatures, acid, and alkaline conditions, and shall be indestructible to microorganisms and insects. The material shall be resistant to deterioration by ultraviolet light and protected until placement as recommended by the manufacturer such that no deterioration occurs. During shipment and storage, the rolls of fabric shall be protected against deterioration from the sun, mud, dirt, dust, and other harmful conditions at all times until their use.

2. Installation Guidelines for Silt Fence: Silt fence shall be installed in the following manner.

- a. First, a small toe-in trench shall be dug along the line where the silt fence is to be placed. The trench shall be a minimum of 6-inch deep and 6-inch wide. The excavated material shall be placed on the front or uphill side of the trench to facilitate backfilling later.
- b. Next, fence posts shall be driven into the back or downstream side of the trench. The posts shall be driven so that at least one-third (1/3) of the height of the post is in the ground. When installing a prefabricated silt fence with fabric attached to the posts, the posts shall be driven so that at least 6-inch of fabric shall be buried in the ground. Most prefabricated silt fences have posts spaced approximately 6 feet – 8 feet apart, which is usually adequate. If there is a low spot where most sediment tends to collect, the prefabricated silt fences can be backed up with bale backup. Posts shall be hardwood with sufficient strength to support a full load of deposited sediment.
- c. Finally, the trench shall be backfilled with the excavated material and tamped so that at least 6-inch of the fabric is securely toed into the ground to prevent under-mining.
- d. The silt fences shall be maintained throughout construction. The Contractor shall conduct regular inspections and after all heavy rains. Damaged fences must be repaired immediately.
- e. At the completion of construction and upon establishment of suitable vegetation as determined by the Division, all silt fence structures shall be removed. Areas disturbed by the removal operation including temporary access roads shall be revegetated. In general, this operation shall consist of regrading, re-fertilizing, reseeding, and mulching.

D. Measurement: Measurement for payment for the above-described work shall be made by actual field measurements of quantities satisfactorily installed and completed. When using silt fence with bale backup the measurement shall be the length of the silt fence installed, plus the length of the straw bale dike installed.

E. Payment for Silt Fence and Straw Bale Dikes: Payment for this item shall be made at the unit price per linear foot of "**Silt Fence.**" The Division shall only pay for quantities of items that are completed.

EARTHWORK

A. Description: This work consists of all work required to excavate, transport, and redeposit material

to the lines and grades in the areas indicated on the Drawing Plan Set. This line item shall include, but not be limited to, the excavation for development of access, work areas channels, drainage ditches, culverts, test pits, blending excess materials, general grading for sediment controls and final grading.

B. Definitions:

General Soils: Considered to be an unclassified soils unit. It is anticipated that the majority of the material to be removed will consist of a mixture of loose, unconsolidated soil, vegetative debris, and rock. Also, large seams of shale and/or boulders not designated for rock excavation may exist within the proposed excavation areas.

Rock: Rock shall be defined as material that cannot be removed by normal excavation methods and must be removed by means such as blasting, ripping, hoe ram or other methods used in the construction industry that are generally accepted practices.

C. Execution:

1. General:

Perform the required clearing and grubbing before starting the earthwork operations. Coordinate the amount of and limit the areas of the project that are cleared and grubbed with the quantity of erosion controls that are placed according to the Drawing Plan set and/or as advised by the Division.

Profiles, cross sections, and grading plans provided on the Drawing Plan Set are only approximate and are to be used as a guide during construction. Fixed elevations shall not be held to; however, the grades shall not be steeper than three to one (3:1) or **those shown on the Drawing Plan Set** or no less than one percent (1%) grade unless approved by the Division.

At the end of each day's work and throughout the earthwork operations, the work areas shall be graded to drain, and be compacted or re-compacted to a uniformed cross-section. All ruts and low spots that could potentially hold water shall be removed.

Positive drainage shall be provided (greater than one percent (1%) grade) for all areas during and after construction unless approved by the Division. No water shall be impounded during or after construction.

Areas not designated for sheet runoff shall be graded to drain into existing or proposed swale areas. This shall include the use of diversion swales and other measures to direct runoff into storm-water collection features. The Division must approve all additional drainage swales and ditches prior to revegetation.

Slope erosion shall be repaired up to the final acceptance of the project.

All areas that settle below final plan elevation or impound water before completion of the Project shall be filled in, regraded, and reseeded.

If earthwork operations encounter any abnormal material such as, but not limited to, drums, tanks, or stained earth or any unusual odors during operations, temporarily discontinue the work in this area, leave the equipment in place, cordon off the area, and notify the Division.

- a. Follow the requirements of the Ohio EPA when handling any contaminated material.
- b. Excavate the contaminated soils to a depth to be determined by the Division. Material hauled away under the item shall be paid separately and **is not to be included** in this item.

If damage occurs to the project site caused by improper excavation or embankment (fill) methods, the Division shall not pay for removing breakages beyond the limits of the planned finished work.

If the damage was caused by the lack of implementing erosion controls, the Division will not pay for reshaping shoulders, slopes and ditches damaged by erosion during construction.

With the approval of the Division either bury or break up existing boulders, not designated for rock excavation, lying within the reclamation area. A boulder shall be defined as any stone larger than 24-inches in diameter. The Contractor shall place the boulders in a stable manner so it will not move or cause future harm.

2. Excavation (Cut):

All “cut” areas shall be reclaimed to original contour upon completion of the project per line item “Approved Resoil”.

Utilize material removal techniques that are generally considered conducive to retaining stability. This includes, but is not limited to, working slopes from the top to the bottom in a manner as to preclude undermining and maintain the work areas in a fashion that will not induce instability.

All excess cut material shall be stockpiled and “tracked in” in the locations shown on the Drawing Plan Set. All cut shall be stockpiled on site and saved for use as designated by the Division

3. Approved Resoil:

Any encountered resoil shall be stockpiled on site and saved for use as designated by the Division.

Approved Resoil shall not be buried or used for general embankment.

4. Exploratory Excavation (Test Pits):

This shall consist of exploratory excavation to determine subsurface features and materials. The location, type, and size of the excavation shall be as directed by the Division.

Excess material, which is unsuitable for backfill, shall be disposed of on site as directed by the Division.

5. Embankment (Fill):

General Embankment (Fill) material shall be placed in uniform lifts not exceeding eighteen (18) inches in thickness and tracked-in using on-site excavation equipment not less than four (4) passes per lift.

The Division shall be notified a minimum of three (3) business days prior to commencement of embankment construction. The Contractor shall receive approval of the prepared sub grade prior

to placing any embankment or fill.

All areas of embankment shall be keyed into the existing ground. Placement of embankment shall only be made on scarified, moist surfaces. No embankment shall be placed on frozen soil, unstable soil, or soil where water is ponded.

No areas of the embankment shall be more than three (3) feet higher or lower than any other adjacent embankment areas during placement.

Rocks larger than six (6) inch diameter shall not be concentrated in any areas of the fill.

If precipitation saturates the embankment construction area, the Contractor shall stay off the embankment construction area until the embankment dries or stabilizes. Embankment construction may be expedited by removing the saturated embankment or drying the embankment by scarifying, plowing, disking, and re-compacting the embankment.

No side dumping of material on slopes shall be permitted. Dumped material in piles or windrows shall be moved and spread into uniformed lifts as described in these specifications or as detailed on the Drawing Plan Set.

Successive loads of material shall be dumped to the best distribution. The distribution throughout the areas of fill shall be such that the fill will be free from voids, pockets, and bridging of materials.

D. Measurement:

1. The approximate amount of earthwork has been listed on the drawings as a total cubic yardage of "cut". However, this figure shall only be used for estimating purposes. There shall be no final measurement.
2. The Division may use three-dimensional measurements where it is impractical to measure material by the cross-section method due to the erratic location of isolated deposits.

E. Payment: Payment for this work, which includes excavation and re-depositing material to the grades as indicated on the Drawing Plan Set, placement, construction of swales and ditches, construction of temporary erosion control measures, test pits, burial, disposal of boulders, segregation, stockpiling of resoil material and offsite disposal shall be made at the contract lump sum price for "**Earthwork**".

12" PE/PVC CULVERT

A. Description: This item covers the quality, material placement and requirements for the installation of the culvert for the temporary stream crossing. This item shall also include the removal of the pipe which shall become the property of the Contractor.

B. Materials:

1. Culvert Pipe: The culvert pipe shall be 12" corrugated N-12 HDPE smooth interior pipe or approved equal and shall meet the AASHTO M294 specification, except the average elongation shall not exceed 7.5 percent when tested as described in that specification. Manufacturer's certification shall be furnished to the Division.
2. Backfill: Backfill material shall be placed around the pipe to as shown on the Drawing Plan

Set. Backfill material shall be included in the unit price for "**No. 304 Aggregate Base**".

- C. Installation: The Division shall verify locations prior to commencing installation. Installation shall be in compliance with all manufacturer's specifications.

The temporary culvert shall be removed at the completion of the project. **The culvert shall become the property of the Contractor at the completion of the project and shall be removed and reused or disposed of at the Contractor's expense.**

- D. Measurement: Measurement of 12" PE/PVC Culvert shall be by actual linear feet of pipe installed as measured in the field.

- E. Payment: The cost for work under this item, including HDPE pipe and installation, shall be at the unit price per linear foot for "**12" PE/PVC Culvert**".

No. 304 AGGREGATE BASE

- A. Description: This work covers the quality, material placement and requirements as an aggregate for the project access as shown in the Drawing Plan Set.

- B. Materials: The materials shall consist of sound and durable rock, gravel or stone of the proper gradation meeting ODOT specifications. The material shall be free from cracks, seams, and other defects, which tend to increase deterioration from natural causes. It shall be highly resistant to weathering and disintegration under freezing and thawing and wetting and drying as evidenced by laboratory tests and/or service records. The Division at any time during the project may reject any materials, at the source or job site, not meeting the requirements of these specifications.

Acceptability of material will be determined by laboratory tests, visual inspection and/or service records as required by the Division. Service records will include documentation to show the material has performed satisfactory on similar structures.

- C. Installation: Upon delivery of the material to the site the Contractor shall install the material in place as shown on the Drawing Plan Set.

The Contractor shall remove the topsoil prior to installation of any access road or work area stone. Topsoil shall be stockpiled adjacent to the location it is removed from. At the conclusion of the project, all topsoil will be replaced it original location as part of the line item "**Site Restoration.**"

All No. 304 aggregate base shall be removed at the completion of the project to allow for the completion of the "**Site Restoration**" line item. **The No. 304 aggregate base shall become the property of the Contractor at the completion of the project and shall be removed and reused or disposed of at the Contractor's expense.**

- D. Measurement: The material shall be measured for payment by the ton (2,000 pounds) for material acceptably placed in the work as determined by certified scale weight tickets.

All material wasted or used by the Contractor for other purposes and any material not placed in the work in accordance with the requirements of the work order and these specifications and drawings shall be measured and not included for payment by weight. A conversion factor of 1.5 ton per cubic yard of No. 304 aggregate base shall be used if necessary.

- E. Payment: Payment this work as specified above shall be made based on the unit price per ton for **"No. 304 Aggregate Base."**

FILTER FABRIC

- A. General: This item shall include all material, labor, and equipment necessary for the installation of the filter fabric for the base of the entrance apron & access drive that will be temporary as specified on the Drawing Plan Set.
- B. Materials: The filter fabric shall be composed of strong, rot-proof polymeric fibers formed into a fabric meeting Ohio Department of Transportation Specifications, Section 712.09, Type "D".
- C. Installation: At the time of installation, fabric shall be rejected if it has defects, rips, holes, flaws, deterioration, or damage incurred during manufacture, transportation, or storage. It shall be laid smooth and free from tension, stress, folds, wrinkles, or creases. The strips shall be placed to provide a minimum width of 6 inches of overlap for each side or end. Any damage to the fabric during its installation or during placement of the stone shall be replaced or repaired by the Contractor at no cost to the Division. The filter fabric shall be protected from damage due to placement of the stone or other materials by limiting the height of the drop of the material.

The Contractor shall install the filter fabric once **the subgrade has been properly prepared and approved by the Division** and prior to the stone in the areas of the entrance apron & access drive that is required to be temporary as described on the Drawing Plan Set. The fabric shall be removed and properly disposed of by the contractor at the completion of this project and shall be part of line item **"Filter Fabric."**

- D. Measurement: Measurement shall be determined in the field by the Chief's representative with no allowance for the overlap of 6-inch recommended above. Measurement shall be based on the length and height of the underdrain/stone drain as indicated on the Drawing Plan Set.
- E. Payment: Payment for all of the work specified above shall be made at the unit price per square yard for **"Filter Fabric"**.

WELL HEAD CONTROL

- A. Description: This work consists of all labor, equipment, and material necessary to establish control of the well. This item shall include the installation of a wellhead control device/flow diverter on the most appropriate well casing as described in the plugging plans.

In the event Division UPC work has been completed on the well, resulting in surface equipment (swages, fittings, valves, gauges, etc.) being installed, the Contractor shall coordinate with the inspector in returning this equipment to the Division for future use. At no point shall the Contractor assume ownership of any surface equipment associated with the well.

- B. Execution: The Contractor is responsible for installing, according to best management practices, a wellhead control device/flow diverter on the well casing.

The casing shall be free from any damages or defects. If required, the casing shall be cut and cleaned of any dirt, oils, and debris prior to welding extensions and/or installation of the diverter.

The Contractor shall supply a cellar with a cement base around the wellhead. This cellar shall be set around the well and extended up to working elevation, as the depressed area around the well head will be modified to establish workable base. This cellar shall be made of steel, concrete, or polyethylene pipe. **The cellar shall be a minimum of 48 inches in diameter. This work shall include a six (6) inch minimum of Approved Cement as specified or Portland Cement in the cellar base with a three (3) inch minimum port near the well. The port shall extend up to within three (3) inches of the well at working height and be used to monitor and contain any gas/oil escaping around the back side of the casing.**

Once a well head control device is installed, all fluids, gases and solids generated by the plugging process shall be diverted into a tank. This tank shall be set a minimum of twenty (20) feet from the well. The Contractor shall also maintain an adequate supply of freshwater at the well for possible well control emergencies, which shall be paid under the line item "**Well Control Fluid.**" The injection point for the kill line will be a minimum of twenty (20) feet from the well.

For the duration of this project the following wellhead control will need to be utilized. The wellhead control device/flow diverter assembly will have two 4.5-inch diameter discharge ports. The diverter lines running from both 4.5-inch diameter discharge ports on the wellhead assembly to the above ground steel tank will consist of two (2) – 4.5-inch diameter steel lines. Both diverter lines will have inline valves (rated minimum 1,000 psi) for control of flow. These lines will discharge into the tank at a downward angle or at an angle that will reduce fluids from splashing or spraying out of the tank if a sustained blow is encountered while drilling out the plugged wells. These lines will be firmly secured to the steel pit with equipment that is capable of withstanding the possible pressures encountered. One of the 4.5-inch diverter lines will be equipped with a 2-inch diameter port and valve that will serve as the kill line access. This port and valve will be installed between the wellhead and the 4.5-inch inline valve.

No plugging operations shall begin until a satisfactory inspection of the prepared well has been completed by the Division.

- C. Measurement: Measurement for payment shall be made by field inspection of units satisfactorily completed and accepted by the Division.
- D. Payment: Payment for the above-described work, which includes all labor, materials, equipment necessary for the well head control shall be made at the cost proposal lump sum price for "**Well Head Control.**"

WELL CONTROL FLUID

- A. Description: The work covered by this section shall consist of furnishing all labor, equipment, and material necessary to provide and use water as a "kill" fluid for the drilling and plugging process of the well.
- B. Requirements: The Contractor shall receive prior approval from the Division before using any onsite waters for the plugging process (i.e. streams, lakes, or ponds). If approved, withdrawing waters of the state shall not exceed 100,000 gallons per day from an individual water source.

The Division will require a minimum of 200 barrels of freshwater well control fluid be maintained on the site during the plugging project.

A mud pump (or equivalent) of sufficient size/capacity shall be required to be onsite at all times

during plugging operations as means to pump well control fluid when required.

- C. **Measurement:** Measurement for payment for the above-described work shall be made by the actual quantity of barrels (bbls) of water used to successfully plug and/or drill the orphan as approval by the Division. The Division will at a minimum pay for the quantity required to be maintained on site.
- D. **Payment:** Payment for the above work shall be made at the unit price per barrel (bbls) for "**Well Control Fluid.**"

LOGGING

- A. **Description:** This work consists of all labor, equipment, and material necessary to determine the total depth of the well and the casing, if a packer is present (along with its depth and thickness), determine bond quality behind the casing and the free point of the casing. The Log should also confirm zones of gas production and formation tops for cementing purposes.
- B. **Execution:** The contractor shall complete the logging of the well bore, casing, tubing, packer, and/or cement to the depth of the existing well bore, casing, tubing, packer, and/or cement. The methods of logging to be used shall be as indicated on the individual plugging plan and may include but not be limited to **gamma ray (GR), casing collar locator (CCL), temperature, bond, and caliper log as well as perforating, shooting etc..** Prior to use, the Contractor shall propose the method of logging and shall be approved by the Division.

The Contractor shall complete the shooting of the casing or tubing at a depth approved by the Division. The Contractor shall propose the material and method for shooting of the casing or tubing, which shall be approved by the Division.

A copy of the completed Log must be submitted to the Division via email at OrphanWellProgram@dnr.state.oh.us.

- C. **Measurement:** Measurement for payment shall be made by field inspection of units satisfactorily completed and accepted by the Division.
- D. **Payment:** Payment for the above-described work, which includes all labor, materials, equipment necessary for the investigation of the well shall be included at the per unit price per each for "**Logging.**"

SHOOTING

- A. **Description:** This work consists of all labor, equipment, and material necessary to sever/shoot a casing or tubing at a determined depth for the purpose of removing the casing or tubing string by the means of shooting.
- B. **Execution:** The Contractor shall complete the shooting of the casing or tubing at a depth approved by the Division. This work shall include logging the well with a standard logging suite at the discretion of the Division to locate free point of casing or tubing in the well.

The Contractor shall propose the material and method for shooting of the casing or tubing, which shall be approved by the Division.

- C. Measurement: Measurement for payment shall be made by field inspection of units satisfactorily completed and accepted by the Division.
- D. Payment: Payment for the above-described work, which includes all labor, materials, equipment necessary for the shooting the casing or tubing made at the unit price per each for "**Shooting**".

WELL PREPARATION & PLUGGING

- A. Description: This work consists of all labor, equipment, and material necessary to prepare the well for plugging and complete all required plugs. This shall include cleanout, drillout, and washover of the well bore to the total depth of the well based on the well description(s) and plugging plan(s), circulating the well bore prior to each plug, setting all required plugs, and verification of each plug depth.
- B. Execution: The Contractor shall supply all equipment needed to complete the well preparation in an efficient manner that will be approved by the Division. This shall include but not be limited to the rig, drill pipe, collars, mud pump, circulating fluid, cementing equipment, mix water, and associated equipment.

Cable tool/spudding rigs shall not be permitted for use unless otherwise authorized by the Division as described under the General Conditions, Part 13 "Substitution During the Project".

Once well head control has been established, the Contractor will cleanout, drillout and/or washover and then circulate the well bore prior to setting any casing or well plugs. The Contractor shall be responsible for having a minimum of two (2) hole volumes of fluid available for circulation.

The Contractor shall identify the diameter of the well bore below the surface casing and cleanout or drillout with a full-size bit to total depth. **In addition to the full-sized bit, the contractor shall also supply a bore brush and/or casing scraper at the appropriate size to fully clean out any casing remaining per the plugging plan.** In any case where an obstruction is encountered and total depth cannot be achieved, the Contractor shall immediately notify the Division. The Contractor shall propose a plan to assess the nature of the obstruction that shall be approved by the Division. Additional work associated with removal of the obstruction shall be described and paid for under the Contingency Specifications and as listed on the Quantity Sheet and agreed upon by the Division.

The Contractor shall trip out or up into the nearest competent cased string and secure all tools at the end of each workday or when work shall be paused for an extended time. Any tools left in the hole during such paused work time shall be at the Contractor's own risk. Any tools or tubing that are lost due to the Contractor's failure to complete the task of tripping out during paused work times shall be at their own expense as well as any work required to then prepare the hole to continue the plugging process (this shall include but not be limited to shooting, fishing, over drilling, lost or damaged tools, etc.). The tripping out of the tools during paused work times shall be incidental to this line item.

Formations within the well bore known to be producing H₂S gas will not be circulated prior to setting a plug.

Prior to setting any plugs the Contractor shall remove all free crude oil by **circulating the wellbore two-hole volumes or until the well is static; a minimum of ten (10) barrels of gel is required to be run ahead of each cement plug that may come into contact with open hole formation at**

the discretion of the Division. This work shall be considered incidental to this line item. No additional payment shall be made for circumstances where the Contractor does not have the appropriate material on location.

Lost Circulation Material (LCM) may be used to aid in obtaining circulation, as approved by the Division. **Lost Circulation Material (LCM) shall NOT be used when tubing smaller than 1.5 inch inside diameter will be utilized. Circulation must be established prior to conducting cementing procedures.** Use of LCM shall be per the “**Lost Circulation Material**” specification included in the Contingency Specification. LCM shall be available at the site during the completion of this line item “**Well Preparation & Plugging.**” **The well shall be in a static condition prior to beginning any cementing activities.**

The Contractor shall set all plugs as described in the **Plugging Plan** to the depths described with the materials described. This shall include setting the bottom plug, intermediate plugs, and the surface plug. All plugs shall be allowed to set for the periods described in the **Plugging Plan**. The Contractor shall determine with the required tools if any plug has dropped. **If a plug has dropped or is determined to not be a competent plug, then drill out of the plug or additional staged plugs may be required at the discretion of the Division as a part of this line item. The Division reserves the right to adjust the Plugging Plan during the plugging process based on site conditions.**

- C. Measurement: Measurement for payment shall be made by field inspection of units satisfactorily completed and accepted by the Division.
- D. Payment: Payment for the above-described work, which includes all labor, materials, equipment necessary for the well preparation and plugging shall be made at the lump sum price for “**Well Preparation & Plugging.**”

TUBING

- A. Description: This item covers all labor, equipment, and material required to supply tubing at the site for the purposes of placement of cement and spacers.
- B. Materials: The Contractor shall supply a 1.5-inch inside diameter (ID) or larger tubing in a condition that will allow for the pumping of cement for the purposes of plugging the well.

For this project the Contractor shall supply up to 3,900 feet of 1.5-inch ID or larger tubing to all the project wells.

- C. Installation: The Contractor will install and remove the tubing as necessary in order to complete the **Plugging Plan**. The Contractor shall maintain ownership at the conclusion of the project of all tubing that was brought to the site for these purposes.
- D. Measurement: Measurement for payment of the above-described work shall be made by actual field measurements per linear foot of tubing delivered to the site.

Tubing shall be measured as one use for the duration of the project.

- E. Payment: Payment for this item shall be made at the lump sum price for “**Tubing.**”

APPROVED CEMENT

- A. **Description:** This item shall cover all labor, materials, and equipment necessary to plug the well as specified in the **Plugging Plan**.
- B. **Materials:** Cement materials shall be approved prior to placement. The cement must conform to the following options:
- a. API Class "A"
 - b. API Class "L"
 - c. ASTM C150 Type 1
 - d. ASTM C595 Type 1L

(Note: These are the only material options that will be approved, any other materials may be submitted to the Division for review but will **not** be approved for this project)

The cement shall contain 2% Calcium Chloride, properly blended, **only if directed** by the Division in advance of placing the cement. **Coordinate with the Division prior to ordering cement.**

The cement shall not contain bentonite or extenders which delay set time or decrease the overall compressive strength unless otherwise noted.

Water used for cementing shall be free of any impurities that will adversely affect set time and compressive strength.

- C. **Installation:** **The Contractor shall notify the Division at least 24 hours in advance of placing the cement, including notification of the type of cement being used for approval.**

Additional wait times may be required for the type of cement used. This wait time shall be incidental to this line item. Upon approval of the type of cement the Division shall inform the Contractor of the required wait times for each staged plug.

Preparation of the well bore, including the running of gel flush ahead, shall be completed per line item **"Well Preparation & Plugging"** prior to placement of the cement.

The cement slurry shall be mixed at the API recommendation, between 15.4 and 15.8 pounds per gallon.

The Cement shall be placed to the depths and intervals described in **Plugging Plan**.

It is the Contractor's responsibility to provide a mud scale for weighing the cement slurry.

When using API Class "L" cement or ASTM C595 Type 1L cement, all the following conditions apply:

- Mill test information must be provided to the applicable Division inspector prior to utilization of API Class L cement or ASTM C595 Type 1L cement. The mill test information must be of a representative sample of the mixture of cement proposed to be used to plug the well. A person is not required to provide the mill test information if the Division already has the mill test information of the mixture of cement for a batch.

- Performance data shall be provided in compliance with Ohio Administrative Code 1501:9-11-07 prior to usage. To determine if Ohio Administrative Code 1501:9-11-07 is met, test results shall include at a minimum slurry density, composition, compressive

strength, free fluids, thickening time, curing pressure, and curing temperature. The data also shall include percent limestone and percent pozzolan material.

- For blended cement containing limestone and pozzolanic material, the combination of the materials shall not exceed fifty per cent by volume.

- A sample of at least 20lbs representative of the of cement mixture proposed to be used in a well must be provided to the Division at the request of the Division.

- A person using API Class L cement or ASTM C595 Type 1L cement shall leave the plugged well in a manner that will allow for further inspection past the contract requirement of three days after the completion of the uppermost plug unless the applicable Division inspector determines that the contract requirement of three days is sufficient.

- D. Setting: Setting times shall be completed as described in the **Plugging Plan**. For the surface plug any void space between the top of the cement and the top of the casing shall be filled to achieve a level cement line with the top of the casing. This shall be done at no additional cost to the Division.

The cement must develop a minimum compressive strength of 500 PSI after 24 hours at well bore temperatures. The Division reserves the right to collect test cylinders throughout the duration of the cementing process.

- E. Measurement: Measurement for payment shall be based on the actual quantity of sacks of cement acceptably placed and shall be verified with delivery tickets. A sack shall be considered to be 94 pounds prior to mixing.
- F. Payment: The above-described work shall be paid for at the unit price per sack for "**Approved Cement.**"

CEMENT MIXING & PUMPING

- A. Description: This item shall cover all labor, materials, and equipment necessary to mix and pump cement as specified in the **Plugging Plan**.
- B. Execution: Cementing equipment required on site to mix and pump casing cement and cement plugs shall be provided until each individual casing cementing or plug cementing is completed. This shall include but not be limited to pump truck, mud pump, and associated equipment.
- C. Measurement: Measurement for payment shall be for each trip to the project site in order to complete the plug(s) as described in the **Plugging Plan**. Payment for staged plugs shall be measured as one unit.
- D. Payment: Payment for the above-described work, which includes all labor, materials, equipment necessary for the mixing & pumping of cement into the well shall be made at the unit price per each for "**Cement Mixing & Pumping.**"

FLUID DISPOSAL

- A. Description: This item shall consist of removing and disposing of the fluid generated from the well plugging process. Fluids to be removed shall be at the discretion of the Division and shall be injected at an approved Class II disposal well as provided by the Contractor prior to removal from the site.

- B. Material: Materials will be defined below as described for the purposes of this scope of work.

Contaminated Fluids: Contaminated fluid will be considered as all fluids used in the circulation of the well bore, fluids utilized as a “kill” substance and/or fluids generated from the well. The Division reserves the right to deem a fluid “contaminated” at its discretion.

Contaminated fluids are further defined as water that contains quantifiable concentrations of oil, natural gas(es), condensate, brine, plugging products, or other oil field waste substances.

Freshwaters: Water that has not been classified as a contaminated fluid and has been stored in an uncontaminated container shall be visually inspected for oil sheen, and field tested for pH and chlorides. The chloride concentration shall be less than 250 mg/L and the pH shall be within a range of 6.5-8.5 standard units (SU). If a water is deemed as freshwater based on these inspections and tests, the Contractor may discharge freshwater into or onto the land in an appropriate manner. Freshwater disposal shall not be paid for under this line item "**Fluid Disposal.**"

- C. Off-Site Disposal: Fluids designated as “contaminated” shall be hauled to an appropriate Class II disposal well. Proof of disposal from the disposal well shall be furnished within three (3) days of acceptance to the Division.

No additional compensation shall be made for onsite fluid storage. If contaminated fluids remain onsite, proper containment shall be established meeting all requirements as described in line item "**Secondary Containment**" at no additional cost to the Division. Onsite storage time shall not exceed 72 hours after plugging activities have been completed.

- D. Measurement: Measurement for payment shall be verified based on documentation proof of a quantity of disposal from the disposal well utilized. Documentation required shall include driver’s haul tickets, fluid disposal tickets and a copy of the paid invoice from the Class II disposal well (dollar amounts may be redacted from the invoice copy).
- E. Payment: Payment shall be made at the unit price per barrel for "**Fluid Disposal.**"

CONTAMINATED MATERIAL DISPOSAL

- A. Description: This item shall consist of removing contaminated soils and cuttings from the site for off-site disposal. Soils and cuttings to be removed shall be at the discretion of the Division and shall be disposed of at an approved EPA licensed landfill as provided by the Contractor prior to removal from the site.

- B. Material:

Contaminated Soils/Cuttings/Drill Fluids: Contaminated soils, cuttings and drill fluids are defined as soils, cuttings and materials in which oil, gas, condensate, brine, plugging products, or oil field waste substances have been released in or on the land and/or materials generated by the Contractor while working on the well.

Contaminated Soils: The Contractor will excavate and properly dispose of all soils from the location that are visibly impacted with oilfield contaminants. Areas to be excavated shall be at the discretion of the Division and/or as shown on the Drawing Plan Set.

Contaminated soils shall be loaded and hauled away as they are excavated.

Cuttings/Drill Fluids: Cuttings and drill fluids generated as part of the plugging process shall be temporarily stored onsite. The Division reserves the right to require removal of these materials at any time. The Contractor shall be aware at all times of capacity limitations. Should removal of materials be required, the Contractor shall be responsible for properly cleaning onsite tanks. Any downtime associated with the removal shall be done so at no additional expense to the Division.

The Contractor shall solidify any residual fluid associated with these materials with Portland Cement or by other means approved by the Division, prior to removal as a part of this line item. Prior to solidification of contaminated materials, the Contractor shall use due diligence to remove fluids from the contaminated materials. Fluids removed from the contaminated materials shall be disposed of per line item "**Fluid Disposal.**"

Soils/material deemed "contaminated" as a result of Contractor negligence during the plugging process will be removed and disposed of at the Contractor's expense. Disposal procedures will conform to all requirements stated within this line item.

- C. Off-Site Disposal: Material designated as "contaminated" shall be hauled to an appropriate licensed landfill. Copies of truck weight tickets from the landfills shall be furnished within 3 days of acceptance to the Division.

No additional compensation shall be made for onsite contaminated material storage. If materials remain onsite, proper containment shall be established meeting all requirements as described in line item "**Secondary Containment**" at no additional cost to the Division. Onsite storage time shall not exceed 72 hours after plugging activities have been completed.

- D. Measurement: Measurement for payment shall be verified based on quantities disposed at the approved EPA licensed landfill. Documentation required shall include driver's haul tickets, certified scale tickets and a copy of the paid invoice from the landfill/waste facility (dollar amounts may be redacted from the invoice copy).
- E. Payment: Payment shall be made at the unit price per ton for "**Contaminated Material Disposal.**"

SALVAGE MATERIAL DISPOSAL

- A. Description: This item shall consist of preparing, removing, and salvaging all materials from the site that have a salvage value as shown on the Drawing Plan Set or as required by the Division. All items to be salvaged shall include all surface equipment, well casing, and production equipment. Salvage items shall also include any hydrocarbon materials (oil, condensate, etc.) that have a marketable value. Salvage items shall be stored onsite within the construction project limits until removed for salvage.
- B. Off-Site Disposal: Prior to removal from the site the Contractor shall supply in writing to the Division an inventory of all materials to be salvaged. On the behalf of the Division the Contractor shall salvage materials inventoried. Once materials have been salvaged the contractor shall reimburse the Division for the salvage value per the line item "**Salvage Material Reimbursement.**"

At the request of the Division, surface equipment deemed as reusable shall be forfeited directly to the Division's onsite representative. This shall include but not be limited to swages, wellheads, fittings, appurtenances, etc. At no time shall salvageable material become property of the

Contractor.

Prior to disposal of any salvage materials from the project site, the Division will complete a radiological assessment of salvage materials that have been provided on an inventory to the Division. **The Division shall be given a minimum of two (2) working days notice to complete the assessment.** Salvage materials staged on the project site shall be staged on a pipe rack where determined applicable by the Division. Salvage materials shall be on an impervious liner that will collect any residual fluids or scale.

Prior to disposal of any salvage materials the Contractor shall prepare, including cleaning, the salvage materials for lawful salvage.

All salvageable material shall be cleaned onsite. The final product shall be non-hazardous and, in a condition, to not cause offsite pollution/contamination during transport and/or disposal. Any downtime associated with proper decommissioning shall be considered incidental to this line item.

- C. Execution: The Contractor shall include in this line item any expense incurred with the removal and the salvaging.
- D. Measurement: Measurement for payment shall be made by field inspection of units satisfactorily completed and accepted by the Division.
- E. Payment: Payment shall be made at the lump sum price for "**Salvage Material Disposal.**"

APPROVED RESOIL

- A. Description: This work shall consist of furnishing all labor, material, and equipment necessary for the hauling, spreading, and grading of the resoil material for the replacement of the removed contaminated soils. This work shall also include shaping for positive drainage and matching the surrounding contours.
- B. Material: Material shall be a good quality resoil and **not** include rocks, stones, and objectionable material over three (3) inches in any one dimension. All resoil that will compose the top eighteen (18) inches of resoil at the ground surface shall be topsoil. Topsoil shall be defined as during excavation having a brown matrix color, less than 50% clay content, and enough organic materials to be generally suitable for vegetative growth.
- C. Installation: Care shall be taken to keep heavy equipment off the surface material after it has been spread. If the resoiling material becomes compacted, the Contractor shall disc the material to a depth of four (4) inches at the Contractor's expense.
- D. Measurement: The material shall be measured for payment by the ton (2,000 pounds) for material acceptably placed in the work as determined by certified scale weight tickets.

All material wasted or used by the Contractor for other purposes and any material not placed in the work in accordance with the requirements of the work order and these specifications and drawings shall be measured and not included for payment by weight.

- E. Payment: Payment for this work shall be made at the unit price per ton for "**Approved Resoil.**"

SITE RESTORATION

A. Description: This work shall cover all operations incidental to the establishment of grasses within the areas disturbed by the Contractor, including the furnishing and sowing of seed; and furnishing and applying of mulch materials, all in accordance with these specifications. Additionally, this work shall include, but not be limited to, repair of grounds and vegetation, including landscaping amenities, ornamental shrubs and trees damaged in any manner during the work operations. All areas shall be properly graded to a smooth final grade with topsoil and blended into adjoining areas at the most moderate slope possible. Seedbed preparation through the use of scarifying equipment is also required. All site restoration work is to be completed within **fourteen (14) days** of the completion of the construction activities. The Contractor may request in writing to the Division an extension for site restoration. Requests shall only be granted based on season or weather conditions.

The area within the fields shall only use Temporary Ground Cover materials.

B. Materials: The materials to be used for restoration shall conform to the applicable requirements of these specifications.

1. Lime: Pelletized lime shall be applied at a maximum rate of 400 pounds per acre. Rates may be adjusted by the Division at the time of application.
2. Fertilizer: Fertilizer shall be commercial grade (19-19-19) and shall be applied at a rate up to a maximum of 20-lbs/1000 sq. ft. Rates may be adjusted by the Division at the time of application.
3. Seed: The varieties of grass seed to be furnished to the project shall bear a tag on each bag of each species showing the lot number, grower's name, percent of purity, percent of germination, and weed content. Tags shall be provided to the Division.

All seeds shall be free from noxious weeds and under no condition shall the total weed content of any lot of seed or seed mixture exceed one-half of one percent by weight.

No seed shall be utilized which has a mix date older than one year. The Division reserves the right to test, reject, or approve all seed after delivery to the project.

Species Composition:

Shade Seed shall be applied to the project area at a rate of 6 lbs/1000 sq. ft. and shall conform to the following seed mixture ratio:

Annual Rye (<i>Lolium multiflorum</i>)	40%
Kentucky Bluegrass (<i>Poa pratensis</i>)	30%
Red Fescue (<i>Festuca rubra</i>)	30%

All areas not designated as yard, shade seed, farm field, or wetland shall use the following seed mix, and shall be sown at the indicated rate. This mixture is listed by recommended planting season and for existing site conditions, and/or intended use. Further information may be found in the Agronomy Guide, Bulletin 472, Cooperative Extension Service, The Ohio State University.

<u>GENERAL SEED MIX</u>	<u>lbs/acre</u>
Orchardgrass (<i>Dactylis glomerata</i>)	15.0
98/85 Kentucky Bluegrass	12.0

Timothy (Phleum pratense)	12.0
Birdsfoot Trefoil (Lotus sp.)	9.0
Red Clover (Trifolium pratense)	8.0
White Clover (Trifolium repens)	7.0
Annual Ryegrass (Lolium multiflorum)	8.5
<u>Perennial Ryegrass (Lolium perenne)</u>	<u>3.5</u>
Total lbs/acre	75

Other types of seed may be substituted if requested by the property owner(s). If such substitutions are made, they are to be made at no additional cost to the Division.

4. Mulching Material: All mulch material shall be free from mature seed-bearing stalks or roots or prohibited or noxious weeds. Any type of hay is not acceptable. Mulch shall include baled wheat straw or oat straw. It shall be dry and reasonably free of weeds, stalks, or other foreign material.
5. Temporary Ground Cover: All crop field areas shall be seeded with Cereal Rye at a rate of 150 lbs/acre. The seed shall be broadcast over the entire disturbed area as a temporary ground cover until the next growing season. Areas of Temporary Ground Cover shall not include lime, fertilizer, or mulching requirements.

For all required materials listed above, the Division reserves the right to request receipts, material specifications and/or weight tickets for verification.

C. Installation:

1. Start of Work: Site restoration work shall begin as soon as possible after the completion of construction. Final site restoration operations shall be completed within fourteen (14) working days of the final construction activities. The Contractor may request in writing to the Division an extension for site restoration. Requests shall only be granted based on **season or weather conditions**.
2. Area Preparation of Soil: Spread and grade available topsoil uniformly over all disturbed areas. All areas to be seeded shall be loosened by discing, harrowing, or other approved methods immediately prior to seeding. The soil shall be loosened to a depth of approximately three inches.

Hand raking shall be required in all areas where machines do not obtain the results desired by the Division.

Following tilling of the soil, the seedbed shall be allowed to firm up.

Final prepared surface shall have a smooth final grade and be appropriate for a residential yard, free from rocks, large dirt clumps and any other foreign debris.

Immediately following area preparation for seeding, materials shall be applied in the following order:

- Lime, as applicable
- Fertilizer, as applicable
- Seed, after broadcasting or otherwise applying the seed, the surface of the seedbed shall be loosely disturbed by hand raking, dragging, and/or cultipacking.

Lime, fertilizer and/or seed shall be sown by approved methods that provide for uniform distribution of the mixes as specified above.

3. Mulching: Apply the equivalent of 100 pounds per 1,000 square feet of clean straw mulch. Mulch shall not be applied in areas requiring Temporary Ground Cover.

Apply mulch to the sown area within 24 hours of seeding at the rate per square feet as specified above and spread to a uniform depth.

The straw shall be placed in a moist condition or shall be moistened immediately after placement.

4. Maintenance and Repairs: The Contractor shall, during construction and prior to acceptance, properly care for all areas mulched and perform all mulching operations necessary to provide protection and establish growth of the seeded areas. Mulch that becomes displaced shall be reapplied at once, together with any necessary reseeding, all at no expense to the Division.

No additional payment shall be made for acts of God, i.e. fire, flood, drought, etc.

- D. Maintenance Period: The permanent planting of trees, shrubs, perennials, annuals, grasses and legumes, etc. shall be deemed to be acceptable if the species that were planted in accordance with the approved plans are established and maintained for one (1) "growing season" as defined below and meeting the following standards:

1. Growing Season: All landscaping shall be guaranteed for a period of one (1) summer growing season after planting. Planting material installed in the Fall shall be in full count and thrifty condition on the next succeeding September 15 at which time replacement shall be determined and scheduled for installation during the planting period of October 15 - December 1 of that same season. Planting material installed in the Spring shall be in full count and thrifty condition on the next succeeding May 15 at which time replacements shall be determined and scheduled for installation prior to June 1 of the same season. All plants installed in the summer shall be guaranteed for one (1) full summer and shall be in full count and thrifty condition the next succeeding September 15.
2. Acceptable Lawn/Turf Areas: A series of four (4) random line transects are to be laid out within the project boundaries. A string one hundred (100) feet long having one (1) foot graduation, shall be placed along the transect line. The person conducting the transect will then walk along the line counting only the markers which are in actual contact with the vegetation. The number of count points are to be recorded as subtotals. When the four transects are completed, the average of the four transects subtotals is then equal to the percent of vegetative cover for the project.
 - a) Residential Lawns: At least one hundred percent (100%) of the land affected shall be judged to be of good quality, and "good" is defined as an area that has at least ninety percent (90%) cover.
 - i. All land affected and having less than ninety percent (90%) cover shall be judged poor and deemed unacceptable; and
 - ii. All areas judged to be good must have species diversity requirements of those recommended for planting.
 - b) Farm & Field Turf: At least ninety percent (90%) of the land affected shall be judged to

be of good quality, and “good” is defined as an area that has at least seventy-five percent (75%) cover.

- i. The remaining ten percent (10%) of the land affected shall be judged to be of fair quality, and “fair” is defined as an area that has at least fifty percent (50%) cover but less than seventy-five percent (75%) cover;
- ii. All land affected and having less than fifty percent (50%) cover shall be judged poor and deemed unacceptable; and
- iii. All areas judged to be good or fair must have species diversity requirements of those recommended for planting.

- c) Severe Decline of a Tree or Shrub: Shall be defined as the death of a major leader or 50 percent of the crown of a tree or shrub or dieback of a plant to the ground, even if that plant is still alive.

E. Measurement: Measurement for payment of site restoration, which includes seedbed preparation, lime, fertilizer as applicable, seeding, mulching, and replacement of landscape amenities (i.e. shrubs, trees, etc.) shall be considered and measured as a unit satisfactorily completed and accepted by the Division.

F. Payment: Payment for this work, which includes seedbed preparation, liming, fertilizing, seeding, mulching, required replacement of all shrubs, trees and landscaping amenities, etc., and general cleanup shall be made at the lump sum price for "**Site Restoration.**"

DEMOBILIZATION

A. Description: This work shall consist of the demobilization of all personnel, plugging related equipment and materials as well as the cleanup of all areas upon completing all other work required under the scope of work for the well site.

B. Execution: Any damage to the road, drives, and/or culverts caused by the demobilization shall be repaired by the Contractor at the Contractor’s expense. All repairs shall be done equal to or better to that which existed prior to construction activities.

This item shall also include the continued and proper use of any maintenance of traffic required within the road right-of-way per Part 7 of the General Specifications.

Also, the Contractor shall be responsible for cleaning mud and dirt associated with construction from all roadway surfaces (public and private) as per Part 7.1 of the General Specification for the duration of the Project and as directed by the Division.

C. Measurement: Measurement for payment will be considered and measured as a unit satisfactorily completed and accepted by the Division. **Demobilization of equipment from the well site to well site for this project shall be considered incidental to this line item.**

If any portion of the item is non-performed (i.e., the mud and dirt are not cleaned from the roadway, damaged items not restored to the satisfaction of the Division, etc.) this is considered unsatisfactory and shall be cause for the rejection of payment of this item.

- D. Payment: The cost of this work shall be included in the lump sum price for "**Demobilization.**"

DETAILED SPECIFICATIONS
FIXED PRICE ITEMS
(Values set by the Division.)

SALVAGE MATERIAL REIMBURSEMENT

- A. Description: This item shall consist of reimbursing the Division for all materials removed from the site for salvage including all surface equipment, well casing, tubing, production equipment, and marketable hydrocarbons.
- B. Reimbursement: The Contractor shall supply salvage receipts to the Division for materials inventoried and removed from the site for salvage. The Division shall use these receipts as deduction of payment that will be represented on the Offer for this line item for this project.
- C. Measurement: Measurement shall be made by salvage receipts amounts.
- D. Payment: Deduction shall be entered as an amount for "**Salvage Material Reimbursement.**"

CROP DAMAGE

- A. Description: This work covers the payment to the owner of the crops on the property for the crop damages/lost yields required to complete the project. The owner of the crop may be the property owner or a tenant of the property owner, either way it must be verified with the landowner who the owner of the crop is prior to making the payment.
- B. Execution: The contractor will verify with the property owner the owner of the crop on each property. The owner of the crop shall receive a payment for the damages associated with plugging the wells. If it is verified that the crops are all the same owner, one payment for all the wells on that property may be paid to the owner of those crops.

The Contractor shall directly pay the owner of the crop. The Contractor shall pay the balance of money due to the crop owner prior to the request of final payment from the Division. Receipt of payment (i.e., landowner waiver) from the landowner shall be furnished to the Division. Final payment will not be made to the Contractor without receipt.

- C. Measurement: Crop damage shall be measured on a per acre bases. Areas for crop damage have been predetermined by the Division according to the construction work limits as shown on the Drawing Plan Set. Any crop damage that occurs outside of these limits shall be paid for by the Contractor.
- D. Payment: Payment for this work as specified above shall be made based on the unit price per acre for "**Crop Damage.**" For corn crops the damages shall be based on a prime farmland yield of 179.7 bushels per acre of corn crop at a market value of \$4.04per bushel or \$726.00 per acre. For

soybean crops the damages shall be based on a prime farmland yield of 46.3 bushels per acre of soybean crop at a market value of \$11.17 per bushel or \$518.00 per acre. Other crops will be paid as determined by the Division. The value per acre is a set value not to be changed by the Contractor.

CONTINGENCY SPECIFICATIONS

CONTINGENCY SPECIFICATIONS WILL ONLY BE DIRECTED VIA A FIELD ORDER FROM THE DIVISION. THE FIELD ORDER WILL DEFINE THE QUANTITY APPROVED. CONTINGENCY SPECIFICATION USE WILL BE DETERMINED BASED ON-SITE CONDITIONS THAT ARE DETERMINED BY THE DIVISION.

ALTERNATIVE WELL CONTROL FLUID

- A. Description: The work covered by this section shall consist of furnishing all labor, equipment, and material necessary to provide and use a weighted brine as a “kill” fluid for the plugging process of the well.
- B. Materials: The Contractor shall provide a ten (10) pound per gallon brine solution.

The Division will require a minimum of 200 of alternative well control fluid be maintained at required sites during the plugging project, as defined in the plugging plan.

A mud pump (or equivalent) of sufficient size/capacity shall be required to be onsite at all times during plugging operations as means to pump well control fluid when required.

- C. Measurement: Measurement for payment for the above-described work shall be made by the actual quantity of barrels (bbls) of kill fluid used to successfully plug and/or drill the orphan well. The Division will at a minimum pay for the quantity required to be maintained on site.
- D. Payment: Payment for the above work shall be made at the unit price per barrel (bbls) for "**Alternative Well Control Fluid.**"

FISHING

- A. Description: This work consists of all labor, equipment, and material necessary to remove and/or clear the well bore as needed in order to reach total depth by the means of fishing the obstruction in the well bore.
- B. Execution: The Contractor shall supply the equipment needed to complete the fishing in an efficient manner that will be approved by the Division. This shall include but not be limited to the rig, impression blocks, and associated equipment. **This shall not include the fishing tools required to complete this work. The Division will develop a negotiated change order to deliver and use the appropriate fishing tools required based on the unforeseen conditions.** Appropriate fishing tools shall be provided for the circumstances encountered.
- C. Measurement: Measurement for payment shall be made by field inspection of the actual quantity of hours in which the drilling rig and other fishing equipment were diligently operating in a manner to remove the obstruction.
- D. Payment: Payment for the above-described work, which includes all labor, materials, equipment necessary for the obstruction removal shall be made at the unit price per hour for "**Fishing**".

MAGNET

- A. Description: This work consists of all labor, equipment, and material necessary to supply a magnet and the required subs as the fishing tool.
- B. Execution: The Contractor shall supply all equipment needed for a magnet fishing tool to be used for fishing out the well bore to the depth of the current obstruction and extracting it. This shall include but not be limited to the rig, subs, and associated equipment. Appropriate tools shall be provided for the circumstances encountered. The work to complete the fishing shall be per line item "**Fishing**".
- C. Measurement: Measurement for payment shall be made by the delivery of the magnet to extract the obstruction as satisfactorily completed and accepted by the Division.
- D. Payment: Payment for the above-described work, which includes all labor, materials, equipment necessary to supply the magnet to extract the obstruction shall be made at the per unit price per each for "**Magnet**".

MILLING/DRILLOUT

- A. Description: This work consists of all labor, equipment, and material necessary to remove an obstruction from inside the wellbore or casing as needed in order to reach a required depth by means of milling/drilling.

This work may include removing metal, cement, grout, wood plugs, failed cement plugs and/or other materials in which typical cleanout operations failed to remove.
- B. Execution: The Contractor shall supply the equipment needed to complete the work in an efficient manner that will be approved by the Division. This shall include but not be limited to the rig, a mud pump, power swivel/power sub, drill string (including collars and casing or tubing) and associated equipment.

This shall not include the bits required to complete this work. The Division will develop a negotiated change order to deliver and use the appropriate bit(s) required based on the unforeseen conditions. Bit types shall be based on the type of material encountered. Bits shall be factory made unless otherwise approved in writing by the Division.
- C. Measurement: Measurement for payment shall be made by field inspection of the actual quantity of hours in which the drilling rig and equipment were diligently operating in a manner to remove the obstruction.
- D. Payment: Payment for the above-described work, which includes all labor, materials, equipment necessary for the obstruction removal shall be made at the unit price per hour for "**Milling/Drillout**".

SEVERING

- A. Description: This work consists of all labor, equipment, and material necessary to sever a casing at a determined depth for the purpose of removing the casing string from the wellbore.

- B. Execution: The Contractor shall complete the severing of the casing at a depth approved by the Division. The Contractor shall propose the material and method for severing of the casing, which shall be approved by the Division. This includes, but is not limited to, locating free point, ripping, shooting, or cutting.
- C. Measurement: Measurement for payment shall be made by field inspection of units satisfactorily completed and accepted by the Division.
- D. Payment: Payment for the above-described work, which includes all labor, materials, equipment necessary for the severing the casing made at the unit price per each for "**Severing**".

LOST CIRCULATION MATERIALS

- A. Description: This work shall include furnishing all labor, materials, equipment, and supplies necessary to expose portions of the well bore to lost circulation materials (LCM) as determined necessary. Lost circulation materials shall be implemented to aid in obtaining well bore circulation prior to any cementing operations.
- B. Materials: Lost circulation materials shall be selected by the Contractor based on site conditions encountered and proposed to the Division for approval.
- C. Measurement: Measurement for payment shall be based on the actual quantity of sacks of lost circulation materials satisfactorily placed and shall be verified with delivery tickets. For estimating purposes, it has been assumed that one (1) sack is equal to fifty (50) pounds.
- D. Payment: Payment for all the above-described work shall be made at the unit price per sack for "**Lost Circulation Materials**".

DRILLING MUD

- A. Description: The work covered by this section shall consist of furnishing all labor, equipment, and material necessary to provide and use a water-based drilling mud for the drilling and plugging process of the well.
- B. Materials: Based on the onsite conditions the Contractor shall propose a water-based drilling mud for approval from the Division. Once a material is approved the Division will require a minimum quantity be maintained at the site during the plugging project based on circumstances encountered.
- C. Measurement: Measurement for payment for the above-described work shall be made by the actual quantity of sacks (50 lbs) of additives for the water-based drilling mud used to successfully plug the orphan well.
- D. Payment: Payment for the above work shall be made at the unit price per sack for "**Drilling Mud**."

NINE SACK GROUT

- A. Description: This work shall include furnishing all labor, materials, equipment, and supplies necessary to plug the well as specified in the **Plugging Plan**.

B. Materials: Nine Sack Grout shall consist of the following materials and requirements:

Constituent	SSD Weight (lbs.)	Volume (ft.³)
Cement Type I-II	846.00	4.30
Sand	2550.00	15.54
Water	417.00	6.68

(SSD means saturated surface dry)

1. Cement Type I-II: Cement shall conform to ODOT CMS Item 701.02 and 701.04.
2. Sand: Sand shall be in accordance with ASTM C150.
3. Water: Water shall be in accordance with ASTM C1602.
The grout shall contain a maximum of 1% entrapped air.

Grout shall have a water to cement ratio (W/C) equal to 0.50 and an overall unit weight of 142.30 pounds per cubic foot.

Slump tests may be done at the discretion of the Division. Slump requirements shall be determined in the field at the time of construction.

The Division has accounted for excess materials due to loss in the wellbore in the quantities on the **Quantity Sheet**.

C. Installation: **The Contractor shall notify the Division at least 24 hours in advance of placing grout.** The surface plug shall be grouted to the depth described in the **Plugging Plan**.

Well preparation and circulation shall be achieved as detailed in the "**Well Preparation & Plugging**" line item and the **Plugging Plan**.

D. Setting: Setting times shall be completed as described in the **Plugging Plan**. For the casing any void space between the top of the grout and the top of the casing shall be filled to achieve a level grout line with the top of the casing. This shall be done at no additional cost to the Division.

E. Measurement: Measurement for payment for the above-described work shall be based upon material quantities satisfactorily installed as well as delivery tickets furnished to the Division.

F. Payment: Payment for all the above-described work shall be made at the unit price per cubic yard for "**Nine Sack Grout**."

DOWNHOLE VIDEOGRAPHY

A. Description: This work consists of all labor, equipment, and material necessary to video record the well bore in order to assess a well bore obstruction.

B. Execution: The Contractor shall supply all equipment needed and complete the videography recording of the well bore to the depth of the current obstruction. The Contractor shall supply the Division with an electronic copy of the videography recorded in a format viewable in readily available current software.

- C. Measurement: Measurement for payment shall be made by the delivery of an acceptable video and photos to the Division of the current obstruction. Measurement shall be per obstruction, not per video or photo.
- D. Payment: Payment for the above-described work, which includes all labor, materials, equipment necessary for the video recording of the current obstruction made at the per unit price per each for "**Downhole Videography**".

WELL CASING TAP

- A. Description: This work consists of all labor, equipment, and material necessary to establish pressure relief control of the well. This item shall include the installation of a tap and valve onto the existing well casing as determined by the Division in the field.
- B. Execution: The contractor is responsible for tapping the well casing, installing a new valve and "relieving" the well of any pressure according to best management practices.

All components associated with the tapping process shall be of size to properly fit the steel casing of interest and be able to withstand a minimum gas pressure of 1000 psi.

The Division shall make the determination for the overall exposed depth of casing. The casing shall be free from any damages or defects. If required, the casing shall be cleaned of any dirt, oils, and debris prior to the installation of the saddle. At the discretion of the Division, further investigation of the well may be required in order to determine the adequacy of casing. This shall be paid for under line item "**Logging**".

After the well casing is cleaned and the saddle is installed, the Contractor will then install the valve and all associated appurtenances. Upon approval from the Division, the Contractor may tap the casing. After tapping, the Contractor shall remove the tap along with the generated "coupon" and close the installed valve.

Once the valve is operational, the Contractor shall attach a 2-inch diameter (minimum) line to the valve which will be placed into a tank. This tank will be set a minimum of twenty (20) feet from the well. The Contractor will then slowly open the valve to relieve the pressure in the well. All fluids, gases and solids generated during this process will be diverted into the tank.

No plugging operations shall begin until the well pressure has ceased, and a satisfactory inspection of the well has been completed by the Division.

- C. Measurement: Measurement for payment shall be made by field inspection of units satisfactorily completed and accepted by the Division.
- D. Payment: Payment for the above-described work, which includes all labor, materials, equipment necessary for the well tap, valve and "relieving" process shall be made at the unit price per each for "**Well Casing Tap**".



SCOPE OF WORK
ASHTABULA #12 PROJECT
Multiple Orphan Well Sites
Ashtabula County, Monroe & Colebrook Townships

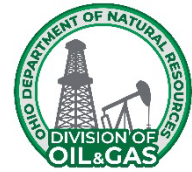

APPENDIX I – OHIO ONE-CALL

THE FOLLOWING ARE REPORTABLE INCIDENTS: *(OAC 1501:9-8-02)*

TYPE OF INCIDENT <small>(All Incident types associated with production operation or other activity regulated under Chapter 1509)</small>	QUANTITY <small>(GAL, BBL,PPM)</small> NOTE: 1 Barrel = 42 US Gallons	ADDITIONAL FACTORS
Release of Gas	<u>Any</u> amount	Resulting from a Blow out; OR
		Uncontrolled Pop-off Valve (in Urban Area); OR
		Any gas release that is a threat to public safety
Release of Hydrogen Sulfide(H₂S) Gas <small>(within the Working Area)</small>	Exceeding 20 ppm (Sustained airborne concentration); For duration > 10 min	OR any H ₂ S release resulting in injury or death of person
Fire / Explosion	N/A	In which a reporting person has called an emergency responder (9-1-1 or Fire Dept)
Release of Oil, Condensate, or Materials Saturated with Oil or Condensate	> 210 US gallons in any 24-hr period (Estimated)	AND the release is OUTSIDE secondary containment & into the environment
Release of Oil, Condensate, or Materials Saturated with Oil or Condensate	> 25 US gallons in any 24-hr period (Estimated); AND the release is outside secondary containment and into the environment	In an urban area; OR
		In an Emergency Management Zone of a surface water public drinking supply; OR
		In a 5-year time of travel with a groundwater-based public drinking supply; OR
		In a 100-year flood hazard area as delineated on the federal emergency management agency's (FEMA) national flood insurance rate map
Release of Refined Oil Products <small>(EX: oil-based drilling fluid, petroleum distillate, spent or unused paraffin solvent, gasoline, fuel oil, diesel fuel, or lubricants)</small>	> 25 US gallons in any 24-hr period	AND the release is OUTSIDE secondary containment & into the environment
Release of Oil, Condensate, or Materials Saturated with Oil or Condensate; OR Refined Oil Products	<u>Any</u> amount	That enters waters of the state in an amount that causes a film or sheen on the surface of the water
Release of Brine or Semi-Solid Waste <small>(EX: drilling mud, sludge, or tank bottom sediments)</small>	> 42 US gallons in any 24-hr period	AND the release is OUTSIDE secondary containment & into the environment
Release of Brine from a Vehicle, Vessel, Railcar, or Container	> 42 US gallons	AND is operated by a person to whom a registration certificate has been issued (ORC 1509.222), or to whom a resolution has been issued (ORC 1509.226)
		AND enters the environment

Release of Hazardous Substance (HS)/ Extremely Hazardous Substance (EHS); OR Mixture or Solution including a HS or EHS	<p>An amount Equal to or > than applicable reportable quantities listed in 40CFR tables; in any 24-hr period</p> <p>If the amount of one or more HS or EHS released is in an unknown mixture or solution, notify when the total amount of the mixture or solution released is <u>equal to or > than</u> the reportable quantity for the HS or EHS with the lowest reportable quantity</p>	<p>List available at: http://oilandgas.ohiodnr.gov/portals/oilgas/pdf/emergency/list_of_lists.pdf</p> <p><i>Code of Federal Regulations (C.F.R.) References:</i> HS- <i>Appendix A 40 CFR Part 302.4</i> EHS- <i>Appendix A 40 CFR Part 355</i></p>
---	---	--

THE FOLLOWING ARE NOT REPORTABLE INCIDENTS: (OAC 1501:9-8-02 (A)(7))

1. Controlled flaring or controlled burns authorized under Chapter 1509. of the Revised Code or under 1501:9 of the Administrative Code or authorized by the terms and conditions of a permit issued under Chapter 1509. of the Revised Code;
2. Properly functioning emission control devices authorized pursuant to Revised Code Section 3704.03;
3. Subsurface detonation of perforation-guns;
4. Seismic shots;
5. Controlled blasting for well site construction

Date Last Edited & Printed: 9/27/2018



SCOPE OF WORK
ASHTABULA #12 PROJECT
Multiple Orphan Well Sites
Ashtabula County, Monroe & Colebrook Townships

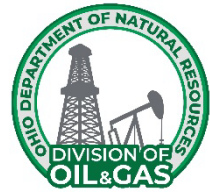

APPENDIX II: Well Photos

John Pazdziorko #1
API #34-007-2-0034-00-00
Ashtabula County, Monroe Township



APPENDIX II: Well Photos

**JA Zevchik Unit #1
API #34-007-2-1658-00-00
Ashtabula County, Colebrook Township**



APPENDIX II: Well Cards

John Pazdziorko #1
 API #34-007-2-0034-00-00
 Ashtabula County, Monroe Township

Ohio Division Of Geological Survey 20034

County ASHTABULA Township MONROE Permit No. 34
 Section 4 N Lot 4 N Tract MONROE Permit Issued 8/29/58
 Measured 625' S/N line and 500' E/W line of farm Quadrangle _____
(30 acres, Lot 4, . . .) 127 acres Twp. Quarter _____
 Land Owner John Pazdziorko Well No. 1 Date Commenced 12/16/58
 Operator Russell McConnell Well No. _____ Date Completed 2/28/59
 Elevation Bar _____ S.L. 894' Total Depth 3145 Plugged Back _____
 Formation Drl'd. To. Clinton Prod. Form. _____ Prod. Nat. 1,460 M
 I.P. _____
 Init. Rock Press. 1000#'/s/96 hrs.
 Casing Record 10 3/4-78'4"; 8-365; 7-2342'3"; 5-3082; 2-3140. Abandoned _____

Formation	Top	Bottom	Remarks	Formation	Top	Bottom	Remarks
shale & gravel	0	90	water @ 90'	slate	2992	3040	
shale & slate	90	365		Little Lime	3040	3070	
slate gray	365	1000		slate	3070	3079	
shale brown	1000	1330		Red Rock	3079	3087	
slate gray	1330	1605		Stray	3087	3106	
shale brown	1605	1690		White Clinton	3106	3116	
slate gray	1690	1807		Sand broken	3116	3124	
slate black	1807	1835		Sand dark	3124	3130	
lime	1835	2010		Red sand	3130	3142	
Oriskany	2010	2170	HFW @ 2118'	White sand	3142	3145	1,460 M Nat
Newburg	2870	2935	HFW @ 2885'				3134-3142
Bottom Lime		2960					
shale	2960	2987					
Lime	2987	2992					

APPENDIX II: Well Cards

**JA Zevchik Unit #1
API #34-007-2-1658-00-00
Ashtabula County, Colebrook Township**

East: GRN, Cal, D		OHIO DIVISION OF GEOLOGICAL SURVEY		21658		Permit No. <u>1658</u>
County <u>ASHTABULA</u>	Township <u>COLEBROOK</u>			Permit Issued <u>2-19-81</u>	Quadrangle <u>Orwell</u>	
Section _____	Lot <u>80</u>	Tract _____		Twp. Quarter _____		
Measured <u>625' NL & 325' WL of Lot 80</u>						
<u>52.0 Acres</u>			<u>"Clinton" - Out - FL.R.T.</u>			
Land Owner <u>J.A. Zevchik Unit</u>	Well No. <u>1</u>	Date Commenced <u>5-9-81</u>				
Operator <u>Giant Petroleum Corporation</u>	Well No. _____	Date Completed <u>5-14-81</u>				
Elevation Bar <u>888'</u>	<u>898'</u> KB	Total Depth <u>3840'</u>	Plugged Back _____			
Formation Drd. To _____	Prod. Form. _____	Prod. Nat. _____				
<u>F/W 62M gal. wtr & 70M#'s sand; Pf(19)3664-3740</u>				I.P. _____		
Init. Rock Press. _____						
Casing Record <u>8 5/8" 300', 150 sks., 4 1/2" 3827', 150 sks.</u>						Abandoned _____

Formation	Top	Bottom	Remarks	Formation	Top	Bottom	Remarks
COMPLETION	3-9-82			X=2,463,000			
Ohio shale		2088		Y= 679,900			
Big Lime	2088	2650					
Salt	2650	3154					
Lockport	3154	3584					
Pkr. shale	3584	3620					
Clinton	3620	3800					
Queenston	3800	3840	LTD				

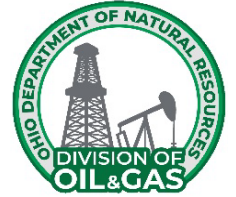

Scope of Work
Quantity Sheet
Ashtabula #12 Project
Ashtabula County, Monroe & Colebrook Townships
Well Name: John Pazdziorko #1, JA Jevchik Unit #1

Permit Number: 34-007-2-0034, 2-1658-00-00

TD = 3154', 3840'

Line Number	Description	Quantity	Unit	
1	Mobilization	2	Lump Sum	
2	Clearing & Grubbing (Pazdziorko #1)	1	Lump Sum	
3	Site Safety	2	Lump Sum	
4	Road Mats	5915	Sq. Ft.	
5	Secondary Containment	2	Lump Sum	
6	Silt Fence	200	Linear Ft	
7	Earthwork (+/-10 Cu. Yd.)	1	Lump Sum	
8	12" PE/PVC Culvert	60	Linear Ft	
9	No. 304 Aggregate Base	30	Ton	
10	Filter Fabric	30	Sq. Yd.	
11	Well Head Control	2	Lump Sum	
12	Well Control Fluid	400	BBL	
13	Logging (GR/CCL/Bond/Caliper/Temp)	2	Each	
14	Shooting	2	Each	
15	Well Prep & Plugging (Pazdziorko #1)	1	Lump Sum	
16	Well Prep & Plugging (Zevchik #1)	1	Lump Sum	
17	Tubing	1	Lump Sum	
18	Approved Cement	1095	Sack	
19	Cement Mixing & Pumping	12	Each	
20	Fluid Disposal	500	BBL	
21	Contaminated Material Disposal	20	Ton	
22	Salvage Material Disposal	1	Lump Sum	
23	Approved Resoil	6	Ton	
24	Site Restoration (Pazdziorko #1)	1	Lump Sum	
25	Site Restoration (Zevchik #1)	1	Lump Sum	
26	Demobilization	2	Lump Sum	
<u>Fixed Price Items</u>				
27	Salvage Material Reimbursement	N/A	Each	N/A
28	Crop Damage (Corn)	\$ 726.00	Acre	\$101.64
29	Crop Damage (Soybean)	\$ 518.00	Acre	\$72.52

Additional/Contingency Services

30	Road Mats	325	Mat/Day
31	Logging (GR/CCL/Temp/Bond/Caliper)	1	Each
32	Alternative Well Control Fluid	400	BBL
33	Fishing	16	Hour
34	Magnet	1	Each
35	Milling/Drillout	16	Hour
36	Severing	2	Each
37	Lost Circulation Materials	50	Sack
38	Drilling Mud	50	Sack
39	Nine Sack Grout	7	Cubic Yard
40	Downhole Videography	1	Each
41	Well Casing Tap	1	Each

Note: This quantity sheet is provided for reference only. The Contractor's Offer must be submitted online through OhioBuys (<https://procure.ohio.gov/bidders-and-suppliers>). Quantities are only an estimate. Payment shall be based on quantities satisfactorily completed.

Each contractor is responsible for logging into OhioBuys and submitting an offer that is responsive to all amendments issued. All offers submitted prior to an amendment being issued shall become null/void and not considered in the opening. All amendments shall become part of the Scope of Work.

Offers must be fully submitted online through OhioBuys (<https://procure.ohio.gov/bidders-and-suppliers>) not later than, 12:00 PM on December 19, 2024.

SHEET INDEX

TITLE SHEET	1
SITE PLAN JOHN PAZDZIORKO #1	2
SITE PLAN JA ZEVCHIK UNIT #1	3
DETAILS	4-5

CONTACT INFORMATION

DIVISION OF OIL & GAS RESOURCES MANAGEMENT
OHIO DEPARTMENT OF NATURAL RESOURCES
2207 REISER AVE. SE
NEW PHILADELPHIA, OHIO 44663
PH: (330) 308-0007 FAX: (330) 308-0011

REGIONAL PROGRAM MANAGER
THOMAS HUFFMAN
PH: (330) 605-2879

ORPHAN WELL INSPECTOR
DAVID MORRISON
PH: (330) 323-9743

PROJECT ENGINEER
JAMES J. JUDGE, P.E.
PH: (614) 314-6153

**OHIO DEPARTMENT OF NATURAL RESOURCES
DIVISION OF OIL & GAS RESOURCES MANAGEMENT**

**ASHTABULA #12
MULTIPLE
ORPHAN WELL SITES**

ORPHAN WELL INFORMATION

WELL NAME	API NUMBER	COUNTY	TOWNSHIP	LATITUDE	LONGITUDE
JOHN PAZDZIORKO #1	34-007-2-0034-00-00	ASHTABULA	MONROE	41.868866°	-80.588229°
JA ZEVCHIK UNIT #1	34-007-2-1658-00-00	ASHTABULA	COLEBROOK	41.520606°	-80.809030°

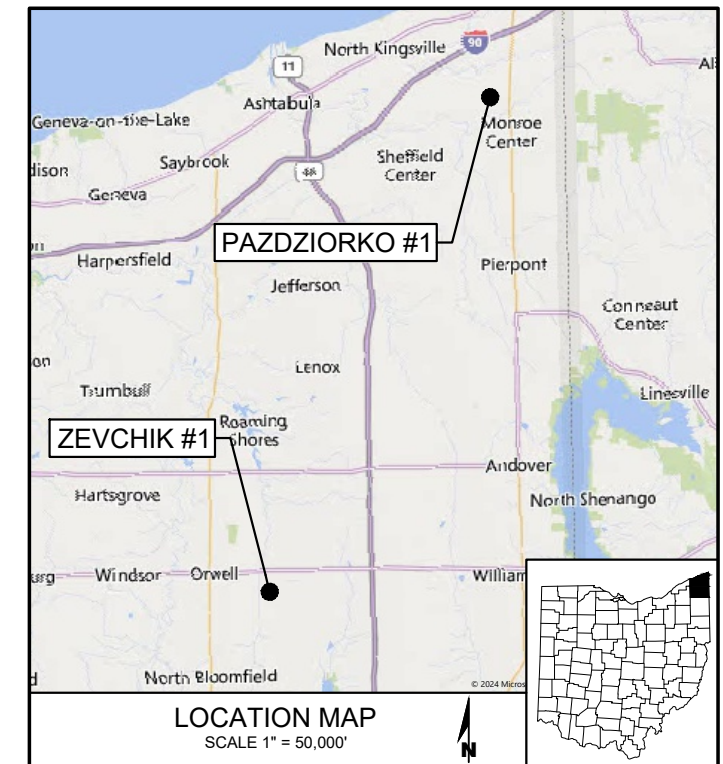

**DIVISION OF OIL & GAS
RESOURCES MANAGEMENT
IDLE & ORPHAN WELL PROGRAM**
<http://oilandgas.ohiodnr.gov>



TITLE SHEET

**ASHTABULA #12
MULTIPLE
ORPHAN WELL SITES**



Call Before You Dig

CALL TWO WORKING DAYS BEFORE YOU DIG
(NON MEMBERS MUST BE CALLED DIRECTLY)

THE LOCATIONS OF EXISTING UNDERGROUND UTILITIES ARE SHOWN APPROXIMATELY, BASED EITHER ON REPORTING BY RESPECTIVE OWNERS AND/OR BY FIELD LOCATION. HOWEVER, THE CONTRACTOR SHALL DETERMINE THE EXACT LOCATION OF ALL EXISTING UTILITIES PRIOR TO COMMENCING WORK AND AGREES TO BE FULLY RESPONSIBLE FOR ALL DAMAGES THAT MIGHT OCCUR BY THE CONTRACTOR'S FAILURE TO EXACTLY LOCATE AND PRESERVE ALL UNDERGROUND UTILITIES. THE CONTRACTOR SHALL MAINTAIN A CURRENT 10 DAY OUPS/OGPUPS TICKET DURING THE ENTIRE PROJECT BY CONTACTING OUPS EVERY 10 DAYS. BOTH OUPS AND OGPUPS CAN BE COMPLETED USING THE OHIO 811 ONE CALL SERVICE BY PHONE OR ON THE WEB.

LEGEND

PROPOSED WORK LIMITS	CWL	EXISTING ORPHAN WELL	
PROPOSED STONE		EXISTING POWER POLE	
PROPOSED MATTING		EXISTING GAS VALVE	
PROPOSED SILT FENCE	SF	EXISTING ELECTRIC METER	
EXISTING EDGE OF PVMT		EXISTING LIGHT POLE	
EXISTING EDGE OF DRIVE		EXISTING IRON PIN FOUND	I.P.F.
EXISTING BUILDING			
EXISTING PROPERTY LINE			
EXISTING TOP OF BANK			
EXISTING TOE OF SLOPE			
EXISTING 1' CONTOUR			
EXISTING 5' CONTOUR			
EXISTING BURIED ELECTRIC	E		
EXISTING OVERHEAD ELEC.	OHP		
EXISTING GAS	G		

THIS DOCUMENT WAS ORIGINALLY
ISSUED BY JAMES J. JUDGE, P.E.
**THIS DOCUMENT IS NOT CONSIDERED A
SEALED DOCUMENT & IS FOR
OFFER SUBMITTAL PURPOSES ONLY**

JAMES J. JUDGE, P.E.
OHIO DEPARTMENT OF NATURAL RESOURCES
DIVISION OF OIL & GAS RESOURCES MGMT

71899

NO.

DATE

REVISION

DESIGN UNIT

O&G ENGINEERING

DRAWN BY: S.T.L.

CHECKED BY: J.J.J.

DATE: 06/28/2024

SHEET NO.

1 OF 5

EDIT DATE: 11/20/2024 11:17 AM EDIT BY: 10185856 DRAWING FILE: M:\ORPHAN WELL PROGRAM\PROJECTS\ASHTABULA COUNTY\ASHTABULA12\ENGINEERING DESIGN\DRAWINGS\FINAL DRAWING\ASHTABULA 12.DWG

GENERAL NOTES:

- UTILITY LINES AND APPURTENANCES ARE SHOWN AS LOCATED IN THE FIELD AND/OR AS REPORTED BY THE RESPECTIVE OWNERS. NEITHER THE NUMBER, TYPE, SIZE, OR LOCATION CAN BE GUARANTEED, AND IT IS THEREFORE, THE RESPONSIBILITY OF THE CONTRACTOR TO VERIFY ALL UTILITY LOCATIONS.
- THE CONTRACTOR SHALL BE RESPONSIBLE FOR ADEQUATELY PROTECTING THE EXISTING BURIED UTILITIES DURING CONSTRUCTION. THIS WORK SHALL BE CONSIDERED INCIDENTAL TO LINE ITEM "MOBILIZATION".**
- THE HORIZONTAL DATUM IS BASED ON NAD83 (2011) OHIO STATE PLANE NORTH 3401, AND THE VERTICAL DATUM IS BASED ON NAVD88 GEOID 12A CORS DERIVED.
- PHOTO IMAGE DATE OBTAINED FROM OHIO GEOGRAPHICALLY REFERENCED INFORMATION PROGRAM (OGrip) FROM THE OHIO STATEWIDE IMAGERY PROGRAM (OSIP III).
- THE CONTRACTOR SHALL WORK WITHIN THE WORK LIMITS AT ALL TIMES DURING CONSTRUCTION.
- TRAFFIC CONTROLS SHALL BE IN ACCORDANCE WITH THE DETAILED SPECIFICATIONS FOR "MOBILIZATION".
- A FLAGGER IN EACH DIRECTION SHALL BE USED WHEN MATERIALS ARE BEING UNLOADED WITHIN THE ROAD RIGHT OF WAY.
- TREE AND OVERHANGING LIMB REMOVAL SHALL BE AS DESIGNATED BY THE DIVISION. REMOVALS SHALL PROVIDE THE CONTRACTOR WITH ADEQUATE SPACE REQUIRED TO COMPLETE THE PROJECT. TRIMMING OF TREES SHALL BE CONSIDERED INCIDENTAL TO LINE ITEMS AS SPECIFIED.
- THE DIVISION MUST BE PRESENT DURING ALL CLEARING OPERATIONS. NO TREES ARE TO BE REMOVED UNLESS DESIGNATED BY THE DIVISION.
- ANY REMOVED TREES AND VEGETATION SHALL BE PLACED INTO BRUSH PILES AT THE DISCRETION OF THE DIVISION.
- ALL "CUT" MATERIAL SHALL BE STOCKPILED ON LOCATION FOR REUSE. STOCKPILES SHALL BE STABILIZED PER LINE ITEM "SITE RESTORATION" UPON ESTABLISHMENT OF TEMPORARY GRADE IF AREAS ARE TO REMAIN OPEN FOR 14 DAYS OR LONGER.
- THE PROPOSED GRADES SHOWN ARE TEMPORARY; UPON PLUGGING THE WELL, THE CONTRACTOR SHALL REESTABLISH EXISTING CONTOUR PER LINE ITEM "MOBILIZATION" USING ONSITE MATERIALS.
- ALL STONE PLACED USING SIX (6) INCH MAXIMUM LIFTS, SHALL BE COMPACTED WITH A MINIMUM OF THREE (3) PASSES PER LIFT USING ONSITE EQUIPMENT.
- AT THE DISCRETION OF THE DIVISION, ALL STONE, FABRIC AND/OR GEOGRID SHOWN ON THE SITE PLAN SHEET(S) AS TEMPORARY SHALL BE REMOVED UPON COMPLETION OF THE PROJECT AND RESTORED PER LINE ITEM "SITE RESTORATION".
- ALL COMPOSITE MATTING INSTALLED SHALL BE INTERLOCKED PER THE MANUFACTURER'S REQUIREMENTS. IN AREAS WHERE POOR SUBGRADE IS ENCOUNTERED MATS CAN BE STACKED OVER TOP OF ONE ANOTHER AT THE DISCRETION OF THE DIVISION.
- SEDIMENT CONTROLS SHALL BE PLACED AT THE DISCRETION OF THE DIVISION.

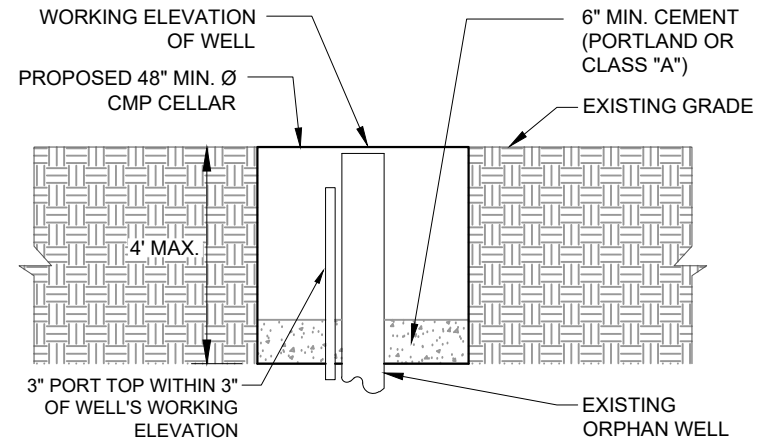

NOTES:
 ALL WORK & MATERIAL ASSOCIATED WITH THE INSTALLATION & REMOVAL OF THE CELLAR SHALL BE CONSIDERED INCIDENTAL TO LINE ITEM "WELL HEAD CONTROL".

TEMPORARY CELLAR
 NOT TO SCALE

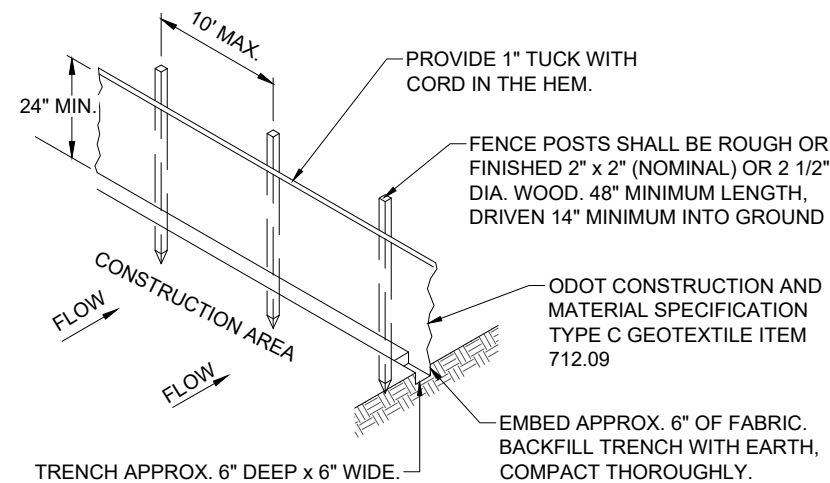

NOTES:
 1. FABRIC TO BE FASTENED SECURELY TO FENCE POST AS PER MANUFACTURER'S RECOMMENDATIONS.
 2. ENDS OF INDIVIDUAL ROLLS OF FABRIC SHALL BE SECURELY FASTENED TO A COMMON POST OR OVERLAPPED 3" MIN.

SILT FENCE DETAIL
 NOT TO SCALE



W21-1
 (500' FROM W20-7,
 BOTH SIDES OF THE
 ENTRANCE)



W20-7
 COVER OR TURN DURING EVENINGS
 OR WHEN BOTH LANES ARE OPEN
 (500' FROM FLAGGER, BOTH SIDES OF
 ENTRANCE)

NOTES:

- THIS WORK SHALL BE PER THE GENERAL SPECIFICATIONS, PART 7: MAINTENANCE OF TRAFFIC AND SHALL BE INCIDENTAL TO LINE ITEM "MOBILIZATION" FOR EACH SITE, UNLESS OTHERWISE NOTED. **THIS WORK SHALL INCLUDE ALL REQUIRED PERMITS FROM THE LOCAL ROAD AUTHORITIES.**
- ALL SIGNS MAY BE MOUNTED PORTABLE MOUNTS.
- CONTRACTOR SHALL FOLLOW THE MANUAL OF UNIFORM TRAFFIC CONTROL DEVICES (MUTCD) FIGURE 6H-1, IN BOTH DIRECTIONS ALONG THE ROADWAY. W21-1 SHALL BE IN PLACE AS SOON AS THE CONTRACTOR ARRIVES TO THE SITE EACH DAY.
- CONTRACTOR SHALL FOLLOW THE MANUAL OF UNIFORM TRAFFIC CONTROL DEVICES (MUTCD) FIGURE 6H-13, LANE CLOSURE ON A TWO-LANE ROAD USING FLAGGERS (TA-13).
- FLAGGERS SHALL HAVE PROPER COMMUNICATION DEVICES AND SHALL BE POSITIONED 20' FROM EACH EDGE OF THE CONSTRUCTION WORK LIMITS. ANY VARIATION MUST BE APPROVED PER LOCATION. **TEMPORARY CLOSURES SHALL NOT BE COMPLETED WITHOUT A FLAGGER.**
- TEMPORARY CLOSURES SHALL BE MINIMIZED TO LESS THAN 20 MINUTES AND THEN THE ROAD SHALL BE FULLY REOPENED TO TRAFFIC.
- ANY WORK IN THE ROADWAY THAT IS REQUIRING MORE THAN 20 MINUTES SHALL BE COMPLETED PER GENERAL SPECIFICATIONS, PART 7: MAINTENANCE OF TRAFFIC WITH THE PROPER PERMITS FROM THE LOCAL ROAD AUTHORITIES AND APPROVAL FROM THE DIVISION.

FLAGGER & CONSTRUCTION SIGNAGE NOTES
 NOT TO SCALE

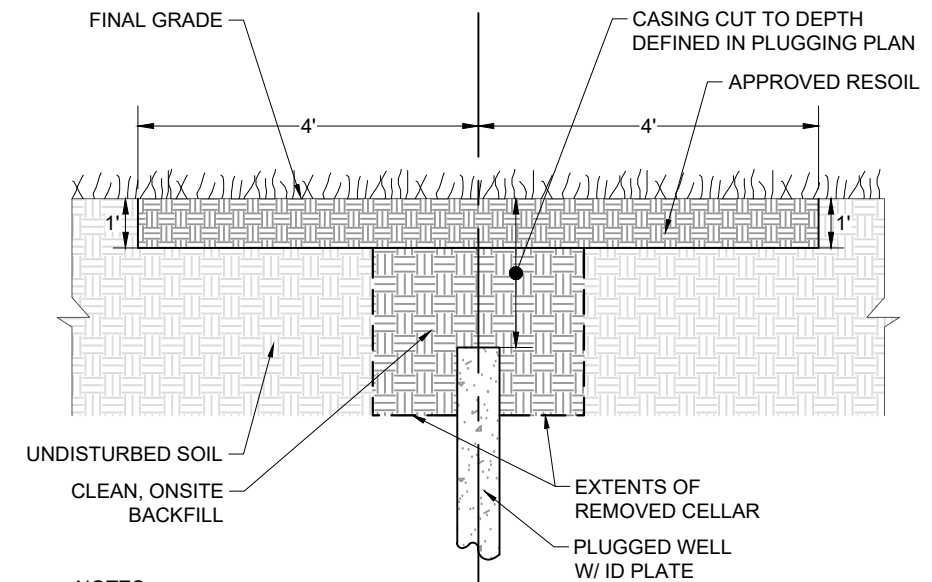

NOTES:
 1. ANY REMOVED MATERIAL FROM AROUND THE WELL HEAD SHALL BE SEGREGATED TO PREVENT ADDITIONAL CONTAMINATION.
 2. ONCE THE WELL IS CUT BELOW GRADE, AN EIGHT (8) FOOT BY EIGHT (8) FOOT AREA, ONE (1) FOOT DEEP SHALL BE EXCAVATED AROUND THE WELL HEAD & REPLACED WITH "APPROVED RESOIL".
 3. REMOVED MATERIAL SHALL BE DISPOSED OF PER LINE ITEM "CONTAMINATED MATERIAL DISPOSAL".
 4. PRIOR TO DELIVERY TO THE SITE OF "APPROVED RESOIL", ON SITE TOPSOIL MAY BE UTILIZED AT THE APPROVAL OF THE DIVISION
 5. ALL WORK NOT INCLUDED IN "APPROVED RESOIL" OF "CONTAMINATED MATERIAL DISPOSAL" SHALL BE INCIDENTAL TO LINE ITEM "SITE RESTORATION".

WELL RESTORATION SECTION
 NOT TO SCALE

EDIT DATE: 11/20/2024 11:17 AM EDIT BY: 10185856 DRAWING FILE: M:\ORPHAN WELL PROGRAM\PROJECTS\ASHTABULA COUNTY\ASHTABULA12\ENGINEERING DESIGN\DRAWINGS\FINAL DRAWING\ASHTABULA 12.DWG



DIVISION OF OIL & GAS
RESOURCES MANAGEMENT
IDLE & ORPHAN WELL PROGRAM
<http://oilandgas.ohiodnr.gov>



DETAILS

ASHTABULA #12
MULTIPLE
ORPHAN WELL SITES

REVISION	
DESIGN UNIT	O&G ENGINEERING
DRAWN BY:	S.T.L.
CHECKED BY:	J.J.J.
DATE:	06/28/2024
SHEET NO.	4 OF 5

EDIT DATE: 11/20/2024 11:17 AM EDIT BY: 10185856 DRAWING FILE: M:\ORPHAN WELL PROGRAM\PROJECTS\ASHTABULA COUNTY\ASHTABULA12\ENGINEERING DESIGN\DRAWINGS\FINAL DRAWING\ASHTABULA 12.DWG



DIVISION OF OIL & GAS
RESOURCES MANAGEMENT
IDLE & ORPHAN WELL PROGRAM
<http://oilandgas.ohiodnr.gov>



DETAILS

ASHTABULA #12
MULTIPLE
ORPHAN WELL SITES

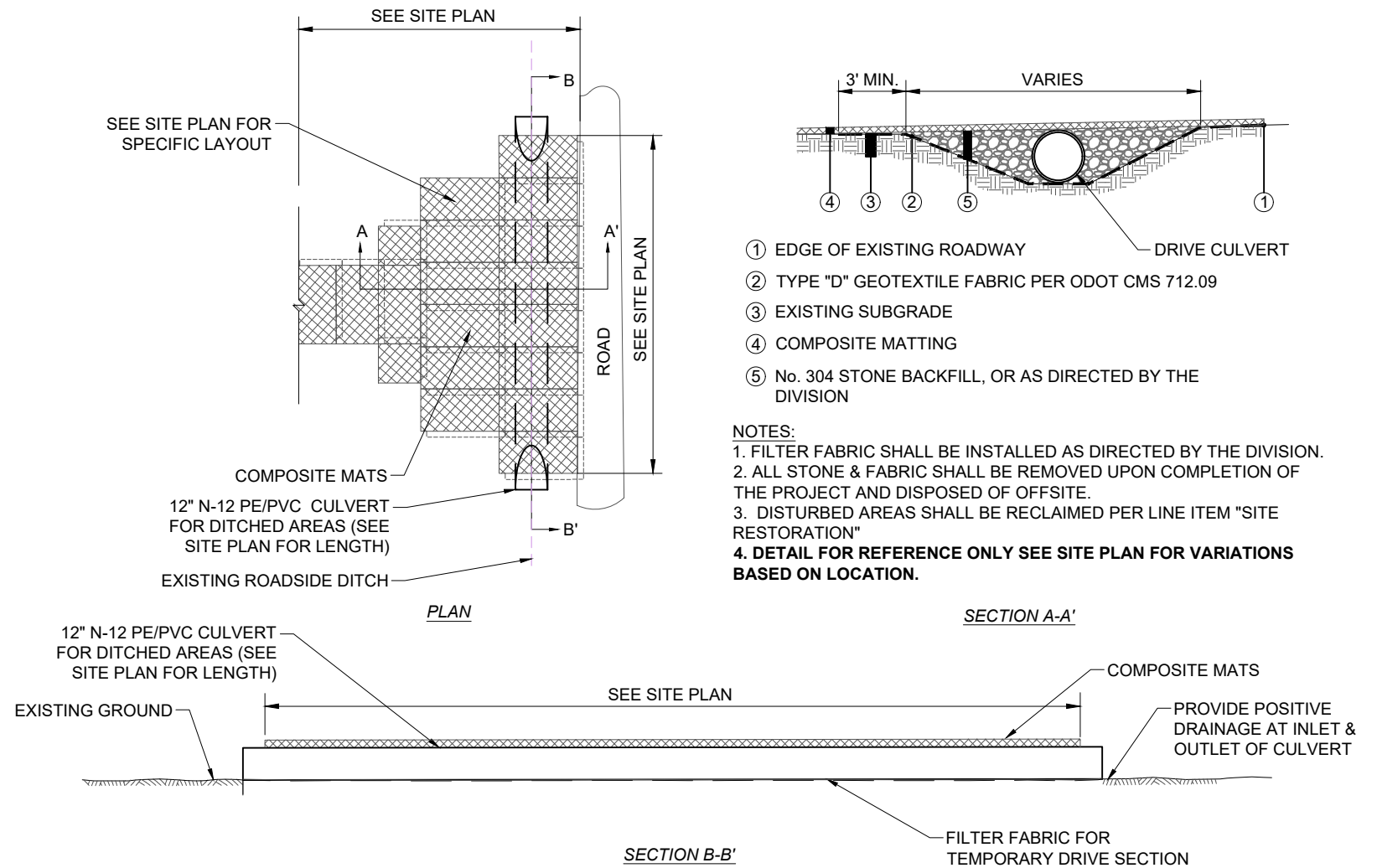

TEMPORARY MATTED ENTRANCE
APRON & ACCESS DRIVE W/ CULVERT
NOT TO SCALE

REVISION
DESIGN UNIT O&G ENGINEERING
DRAWN BY: S.T.L.
CHECKED BY: J.J.J.
DATE: 06/28/2024
SHEET NO. 5 OF 5