

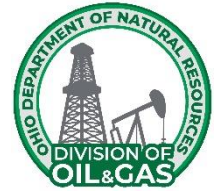

SCOPE OF WORK
GALLIA #6F PROJECT
Quickle Farms #1
Gallia County, Springfield Township



PROJECT DESCRIPTION

FEDERAL FUNDED PROJECT:

Note: This project will be **FEDERALLY FUNDED**. Contractors/subcontractors shall comply with additional requirements related to this project being federally funded.

The Gallia #6F Project shall include the following wells:

<u>Well Name</u>	<u>API Number</u>	<u>County</u>	<u>Township</u>	<u>Ingress/Egress Latitude, Longitude</u>	<u>Wellhead Latitude, Longitude</u>
Quickle Farms #1	34-053-9-0012-00-00	Gallia	Springfield	38.923452, -82.293803	38.926061,-82.295757

PROJECT SCOPE OF WORK:

This project includes mobilization, access and well site development, drilling or cleaning out of and plugging of the above Orphan Well, storage and disposal of all materials generated during the plugging of the wells, decommissioning, removal, storage and disposal of all casing, tubing, well and production equipment and affiliated lines and restoration of all areas disturbed during this project.



SCOPE OF WORK
Gallia 6F PROJECT
QUICKLE FARM
Gallia County, Springfield Township

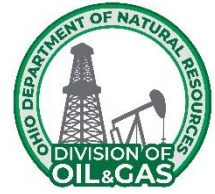

GENERAL SCOPE OF WORK

The Contractor, the Contractor's agents, representatives, and subcontractors shall perform this Plugging Project in accordance with Ohio Revised Code 1509, Ohio Administrative Code Chap. 1501:9-11 and 1501:9-12, the Agreement, and in accordance with the following documents that are attached hereto and made a part hereof:

1. Project Description;
2. General Scope of Work;
3. Davis Bacon Wage Requirements
4. General Conditions;
5. General Specifications;
6. Sequence of Work;
7. Well Description;
8. Plugging Plan;
9. Detailed Specifications;
10. Appendix I – Ohio One-Call;
11. Appendix II – Well Records;
12. Quantity Sheet;
13. & Drawing Plan Set.

Subject to the Contractor's compliance with this Scope of Work, Contractor is solely responsible for and has control over all plugging and reclamation construction means, methods, manners, techniques, sequences, and procedures, for safety precautions and programs in connection with the Plugging Project, and for coordinating all portions of the Plugging Project.



SCOPE OF WORK
Gallia 6F PROJECT
QUICKLE FARM
Gallia County, Unknown Township

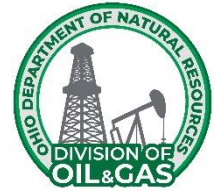

DAVIS-BACON WAGE REQUIREMENTS

PART 1: PAYMENT OF PREVAILING WAGES

- 1.1 The Contractor/Subcontractor shall pay the prevailing wage rates of the Project locality, as determined by the U.S. Secretary of Labor, to laborers and mechanics performing Work on the Project.
- 1.2 The Contractor/Subcontractor shall comply with the provisions, duties, obligations, and is subject to the remedies and penalties of 40 U.S.C. parts 3141-3144, 3146 3147; 42 U.S.C. part 3212 The Davis- Bacon Act; and 40 U.S.C. parts 3701-3708 The Contract Work Hours and Safety Standards Act.
- 1.3 The Contractor/Subcontractor shall submit all payroll reports in compliance with the requirements of Section 1.2 for all employees.
- 1.4 By executing a Contract, the Contractor/Subcontractor certifies that it based its Bid upon the prevailing rates of wages as ascertained by the U.S. Secretary of Labor.
- 1.5 The Contractor/Subcontractor may access the U.S. Secretary of Labor at its website, **<https://sam.gov/content/wage-determinations>**, to obtain the current wage rates. A copy of the current wage rates is included herein.

PART 2: PAYROLL SCHEDULE

- 2.1 Within 10 days of the date of the Notice to Proceed, the Contractor/Subcontractor shall provide the Contracting Authority's Prevailing Wage Coordinator with a schedule of dates during the term of the Contract on which wages shall be paid to employees for the Project.

PART 3: PAYROLL REPORTS

- 3.1 The Contractor/Subcontractor shall submit payroll reports with each Payment Request, which reports shall be certified by the Contractor/Subcontractor that the payroll is correct and complete, and that the wage rates shown are not less than those required by the Contract.
 - 3.1.1 Each payroll report shall indicate the period covered and include a list containing the name, address, and last four digits of the social security number of each employee of the Contractor/Subcontractor paid for the Work.

- 3.1.2 Each payroll report shall list the number of hours each employee worked each day on the Project during the reporting period, the total hours each day on the Project per job classification, the total hours each week on the Project, the employee's hourly rate of pay, job classification, hourly rate of fringe benefits, all deductions from wages and net pay (actual wages paid).
- 3.1.3 Each payroll report shall list each fringe benefit and state if it is paid as cash to the employee or to a named plan.
- 3.1.4 The Contractor/Subcontractor shall submit apprenticeship agreements for all apprentices utilized on the Project.
- 3.2 The Contractor/Subcontractor shall maintain payrolls and basic payroll records during the course of the work and shall preserve them for a period of three years from the completion of the Contract for all laborers and mechanics, including guards and watchmen, working on the Contract.
- 3.3 The records to be maintained under this paragraph shall be made available by the Contractor/Sub-contractor for inspection, copying, or transcription by authorized representatives of the Contracting Authority and the U.S. Department of Labor, and the Contractor or Subcontractor will permit such representatives to interview employees during working hours on the job.
- 3.4 Certified payroll submittal shall be made via software designated by the Division.



SCOPE OF WORK
Gallia 6F PROJECT
QUICKLE FARM
Gallia County, Springfield Township

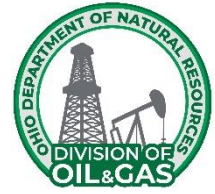

GENERAL CONDITIONS

PART 1: OHIO DEPARTMENT OF TRANSPORTATION SPECIFICATIONS

This Gallia 6 Project (Project) references the Ohio Department of Transportation (ODOT) Construction and Material Specifications (ODOT CMS). Any reference to these specifications is to ODOT's most current version of the specifications. The ODOT CMS can be found at:

<https://www.dot.state.oh.us/Divisions/ConstructionMgt/OnlineDocs/Pages/2023-Online-Spec-Book.aspx>

PART 2: PRE-SITE MEETING

The Contractor or a Contractor's representative must attend the pre-site meeting. A contractor representative may only be a representative for one DAS pre-qualified contractor on a project.

Failure to attend the pre-site meeting is grounds for the Division to reject the Contractor's Offer. A Contractor or Contractor's representative must be present for the entire pre-site meeting to be considered in attendance.

The Ohio Department of Natural Resources, Division of Oil & Gas Resources Management (Division) intends to begin the pre-site meeting on time. At the meeting, the Division will circulate and collect attendance sign-in forms to all contractors or contractors' representatives present. Only those contractors or contractors' representatives in attendance throughout the pre-site meeting, including the discussion of the Scope of Work, will be considered present for the pre-site meeting.

PART 3: MODIFICATIONS TO THE SCOPE OF WORK PRIOR TO AWARD

The Scope of Work may only be altered by written modification. The Division may issue an Amendment to the Scope of Work and will provide notification of the Amendment by email to all Department of Administrative Services (DAS) pre-qualified Contractors. Each Contractor is responsible for logging into OhioBuys and submitting an offer that is responsive to all Amendments issued. All offers submitted prior to an Amendment being issued shall become null/void and not be considered in the opening. All Amendments shall become part of the Scope of Work.

Any interpretation or clarification of the Scope of Work made by any person other than the Division, or in any manner other than a written Amendment, is not binding and the Contractor cannot rely upon any such interpretation or clarification.

The Contractor cannot, at any time after the award of the Scope of Work, be compensated for any issue with the Scope of Work, including alleging insufficient data, incomplete, ambiguous, conflicting, or erroneous language, or incorrectly assumed conditions regarding the nature or character of the work.

PART 4: PERMIT AND INSPECTION REQUIREMENTS

The Division will obtain and pay for all building and U.S. Army Corps of Engineers permits unless otherwise specified in the Detailed Specifications. However, the Contractor shall determine and include in the Contractor's Offer Sheet the costs required to obtain and pay for all other requirements by the applicable governmental agencies; including but not limited to, all certificates of inspection/operation, guarantees, licenses, etc. required to complete the work as described within this document. The contractor shall follow all applicable laws and permit requirements, the Division will not be held responsible for damages that result from violation of laws or permits.

PART 5: INSTRUCTIONS FOR PREPARING AN OFFER

A Contractor's offer must be submitted online through **OhioBuys**. (<https://procure.ohio.gov/bidders-and-suppliers>). **All offers submitted prior to an Amendment being issued shall automatically become null/void and not be considered in the opening.**

Offers shall include labor, equipment, and material cost plus a proportionate share of the Contractor's overhead costs, other indirect costs, and anticipated profit. The offer must be mathematically and materially balanced. A "mathematically unbalanced offer" is an offer containing lump sum or unit price items that do not include reasonable labor, equipment, and material costs plus a reasonable proportionate share of the Contractor's overhead costs, other indirect costs, and anticipated profit. A mathematically unbalanced offer typically contains token prices (i.e. \$1 prices), front loadings, or prices with large variations from the engineer's estimate. A "materially unbalanced offer" is a mathematically unbalanced offer that will not result in the lowest ultimate cost to the Division.

During the Division's initial review of offers, if the Division finds an offer may be mathematically unbalanced, the Contractor may be required to submit proof of the mathematically unbalanced line items' proposed cost within 24 hours after notification from the Division. At a minimum, a Contractor may be required to submit copies of all material/rental quotes, intended labor costs (hours/rates), and contract agreements with subcontractors to support their offer. If the Contractor fails to submit the required proof, the Contractor's offer shall be deemed withdrawn from consideration. The Division shall evaluate the documentation and may verify quotes with vendors. After a review of the documentation, the Division will reject any offer it determines is mathematically and materially unbalanced.

A DAS pre-qualified Contractor shall not submit offers on a project in which the contractor has committed as a subcontractor, who will perform more than 50 percent of the project as a subcontractor, to another DAS pre-qualified Contractor submitting an offer on the same project. Any DAS pre-qualified Contractor who submits an offer and will not self-perform more than 50 percent of the work shall self-report to the Project Engineer in writing prior to award the project's subcontractors and each subcontractor's percent award of the project. Any DAS pre-qualified Contractor who submits an offer shall supply upon request to the Project Engineer the project's subcontractors and each subcontractor's percent award of the project. Substitution of subcontractors after award shall be per the DAS contract. A DAS pre-qualified Contractor who will perform more than 50 percent of the work on a project as a subcontractor will have this project considered when reviewing whether the Contractor is behind schedule for awarding work. Additionally, when the Division is considering if a Contractor is behind schedule, all Orphan Well Program work and deadlines will be considered (Construction Manager at Risk subconsultant work and Landowner Pass-through Payment Program).

A Contractor shall maintain an up-to-date schedule on file with the Division that sets forth dates by which the Contractor will plug each well that the Division previously awarded to the Contractor. A Contractor

shall update their work schedule as often as necessary to maintain a current schedule with the Division. To be awarded new contracts, the Contractor must be able to complete all previously awarded work within the due dates set in each contract with the Division. Upon request, a Contractor shall provide an up-to-date schedule to the Division that reflects when all awarded work will be completed.

Please note that a Contractor's offer must be submitted online through OhioBuys.

1. Refer to the Scope of Work posted in OhioBuys with this solicitation.
2. **Only Contractors who are pre-qualified to offer this service on an existing State Contract beginning with CSP900-922 (DAS Index No. MAC110) may respond to this solicitation.** All CSP900922 Contract Terms & Conditions apply to this solicitation. No additional terms and conditions will be accepted. The Division will reject Offers from any Contractor that is not pre-qualified.
3. Completion of the grid is required and will be considered the response for evaluation. No outside or additional documentation will be considered.
4. Fixed prices will be automatically added to Contractor's proposals when shown. Contractors are not to enter pricing for fixed price items.
5. Confirm that your offer has been successfully imported into OhioBuys for all items before submitting. Incomplete offers and/or attachments will not be evaluated.
6. The most recent offer submitted in OhioBuys will be the offer that is evaluated, all prior offers submitted in the same solicitation will not be evaluated.
7. **The Contractor or Contractor's representative must attend the pre-site meeting.** Failure to attend the site meeting is grounds for the Division to reject the Contractor's Offer.

PART 6: DIVISION'S OFFER SELECTION

Except when the Division rejects an offer, the Division will select the lowest offer submitted to the Division. The Division may reject an offer if any one of the following applies to the Contractor's offer:

- Is not submitted online through **OhioBuys**;
- Fixed reference prices and/or any other imported information is incorrectly and/or not imported into **OhioBuys**;
- Is conditional;
- Is a mathematically unbalanced offer and a materially unbalanced offer;
- Is behind schedule on other projects with the Division;
- Is not able to schedule this project within the contract due dates.
- Is committed to perform more than 50 percent of the work on this project as a subcontractor to another DAS pre-qualified Contractor on the project;
- Is a prime Contractor who has more than 50 percent of the work committed by a subcontractor who also submitted an offer as prime Contractor; or
- Failed to identify prior to award project subcontractors and their percent award upon request.

PART 7: WITHDRAW OF OFFERS

At any time prior to the opening of the Offers, a Contractor may submit a written request to the Division, at the location where the Offers are received, to withdraw its Offer. The request to withdraw the Offer must be signed by the person who executed the Offer.

PART 8: EFFECTIVE DATE AND TERM

The effective date of this Project is the date of the Letter to Proceed that is sent to the Contractor. The Contractor must start work at the project site within three (3) months of the end of the contract and the Contractor shall continue diligently working toward the completion of the project once work has commenced. The Project must be completed **six (6) months after the effective date** or by June 30, 2027, whichever is sooner. If the Project terminates on June 30, 2027 and the Project is not completed, the Scope of Work may be renewed on the same terms if the Division sends written notice to the Contractor. Failure to complete work by the contract due dates may result in the suspension or termination of the contract and may result in the Division pursuing the Suspension and Termination and/or the Contract Remedies sections defined in the MAC 110 contract.

PART 9: TERMINATION AT WILL

The Division may terminate this Scope of Work without cause. Any payment due to the Contractor at the time of termination by the Division shall be paid to the Contractor on a pro rata basis.

PART 10: RELATIONSHIP BETWEEN COMPONENTS OF THE SCOPE OF WORK

This Scope of Work includes drawings that are duplicates of drawings on file with the Division. The Scope of Work documents are complementary. All sections of the Scope of Work are binding. The titles and headings in the Scope of Work are for reference and in no way affect the interpretation of the provisions of the Scope of Work. Further, if any part of this Scope of Work is found to be unenforceable, no such event will affect the enforceability or applicability of any other part of the Scope of Work.

If a conflict between the drawings and the specifications arises, the Contractor must notify the Division. In the event of a conflict of any provision in the Scope of Work the order of priority within the Scope of Work is as follows: Drawings, Detailed Specifications, General Specifications, Plugging Plan, and Sequence of Work.

PART 11: CONTRACTOR'S RESPONSIBILITY FOR SUBCONTRACTORS

The Contractor is responsible for the conduct of its subcontractors and for persons its subcontractors directly or indirectly employ.

PART 12: USE OF DOMESTIC STEEL AND BUY AMERICAN ACT (For Federally Funded Projects only)

For infrastructure projects that utilize federal funds, the contractor and subcontractors shall comply with Executive Order No. 14005 Ensuring the Future Is Made in All of America by All of America's Workers; the Code of Federal Regulations Title 2, Subtitle A, Chapter I, Part 184; U.S.C. 52.225-11 Buy American-Construction Materials under Trade Agreements (Nov 2023) clause; and Buy America Preferences for Infrastructure Projects and the Infrastructure and Jobs Act (Public Law 117-58) Division D, Title IX, Subtitle A, Part I, Buy America Sourcing Requirements. The Contractor and subcontractors are required by law to supply domestically produced iron or steel products, manufactured products, and construction materials such as non-ferrous metals (steel, iron, aluminum), plastics, PVC pipe, glass, fiber optic cable, optical fiber, engineered wood, and lumber products for infrastructure on all projects funded in whole or in part with federal funds. The Infrastructure, Investment, and Jobs Act (Public Law 117-58) Division D, Title IX, Subtitle A, Part I, Buy America Sourcing Requirements exempts cement, cementitious materials, aggregates such as stone, sand, gravel, or aggregate binding agents or additives from these requirements.

PART 13: STANDARDS

If the Division identifies a “standard” by reference to manufacturer and/or model number, all offers will be evaluated to ensure that the identified standard is used. The Division will not consider an offer in which a substitution for the standard is offered. After the Letter to Proceed is issued, the Contractor may submit a written proposal for a substitution of a standard.

PART 14: SUBSTITUTIONS DURING THE PROJECT

After the Letter to Proceed is issued, the Contractor may offer substitutions for the standards set forth in the Scope of Work. The decision to allow substitution is solely within the discretion of the Division, which will consider, among other factors, availability, time of delivery, the aesthetic value of the proposed substitution, general differences in the knowledge of the product, service history, quality, efficiency, performance, and architectural, engineering, inspection, testing and administrative expenses. Any changes to the Offer price and/or Scope or Work must be memorialized by a Field Order or Change Order, as applicable. The savings in cost in allowing any substitutions during the Project will be solely to the benefit of the Division.

PART 15: QUANTITIES OF WORK

15.1 Unit Price Items

For items in the Offer that require a unit price, the quantities listed on the Offer Sheet are an approximation and are to be used only for the comparison of offers. The scheduled quantities may be increased or decreased without invalidating or altering the Offer and will be considered within the Scope of Work.

Payments for unit price items will be made to the Contractor for actual quantities of work performed and materials furnished in accordance with the Scope of Work; however, the Contractor may not exceed the unit quantities shown on the Offer Sheet without prior written approval of the Division through a Field Order. Even if the Contractor determines that additional unit priced quantities (above and beyond the original Offer Sheet quantity) are required to meet plan and/or specification dimensions, the Contractor must not exceed the Offer Sheet quantities without prior written approval of the Division. The Division will not pay for quantities above and beyond the Offer Sheet quantity without prior written approval of the Division.

15.2 Lump Sum Items

For items in the Offer Sheet that require a lump sum price, the Division will not pay for work, materials, or equipment that exceeds the amount provided by the Contractor on the Offer Sheet. The lump sum price on the Offer Sheet must include all work, materials, and equipment necessary to properly complete the Project.

15.3 Additional/Contingency Items

The contingency items set forth in the Offer Sheet are not projected as necessary to complete the Project. Rather, the contingency items will first be used when unforeseen work arises, and the Division determines the contingency item is applicable. To be compensated for contingency items, the Contractor must have a written Field Order from the Division authorizing the contingency item in a specified quantity. Use of contingency items will not require the execution of a Change Order. The Contractor must be prepared to supply all items identified in the contingency specifications for use on this Project.

PART 16: OMISSIONS IN THE SCOPE OF WORK

If the Contractor notices an error or omission in the Scope of Work during performance of the Project, the Contractor shall immediately notify the Division of such omission or error and shall not proceed with the Project until directed by the Division. Any work performed by the Contractor prior to clarification by the Division may not be entitled to compensation.

PART 17: INTERPRETATIONS CONCERNING THE SCOPE OF WORK

During the Project, if a question arises on the Scope of Work, the labor or materials to be supplied, or costs potentially exceeding the Contractor's Offer, such questions must, prior to the work being performed, be submitted to the Division for a determination. A Division determination will be issued in writing and any work performed prior to such a determination will be performed at no cost to the Division. The Division will also begin executing a Change Order, when appropriate.

If the Division receives a written question concerning the Project, the Division will determine if the work must be performed by the Contractor at no increase in price to the Scope of Work. If so, the Division will issue a Field Order setting forth the Division's determination. Each Field Order issued must be signed by the Contractor acknowledging receipt. If the Contractor disagrees with the Division's interpretation in a Field Order, the Contractor may submit a protest by certified mail to the Chief within ten (10) days following the date of issuance of the protested Field Order. However, the Contractor must immediately proceed with the instructions given in the issued Field Order.

If, upon receipt of a written protest of a Field Order, the Division determines that the work referred to in the protest is outside the Scope of Work, the Division will not issue a Field Order and instead will issue a Change Order.

Field Orders, which are interpretations of the requirements of the Scope of Work, may be issued by the Division at any time during the performance of the work. The Contractor, at all times, is required to immediately execute the instructions of all issued Field Orders, which includes acknowledgment and signature of issued Field Order documents.

PART 18: CHANGES IN THE SCOPE OF WORK

18.1 The Division's Right to Require Change Orders

The Division may issue a Change Order directing the Contractor to immediately perform extra work that differs from the Scope of Work. The Contractor shall perform the work as directed. The changes in the work will consist of additions, deletions, or other revisions. When the Contractor performs the work, the Offer amount will be adjusted as described within this Scope of Work.

If the Contractor protests the issuance of the Change Order, any such protest has no bearing on any work requirements arising out of the Change Order in that the Contractor must immediately perform the work required in the Change Order so as not to delay the progress of the work at the Project.

18.2 Unauthorized Work

Only work performed under the Scope of Work or work authorized by a Field Order or a Change Order is eligible for compensation. If the Contractor performs any work or purchases any materials without an approved, applicable Field Order or Change Order, such work performed, and purchases made are within the Scope of Work at no additional cost to the Division.

18.3 Contractor's May Request Change Orders

If the Contractor determines that the Scope of Work does not address conditions at the Project, the Contractor may provide written notice to the Division of the conditions and request a Change Order. No oral communications will be acceptable as justification for a Change Order.

Fishing/milling tools and associated appurtenances submitted as Change Order items shall be at cost. No markup on these items will be accepted by the Division.

18.4 Determining Price of a Proposed Change Order

The following methods will be used to determine the price of a proposed Change Order:

- a. If a Change Order involves items not listed on the Offer Sheet, the Contractor must present the Division with labor and/or material price quotes for the proposed Change Order item(s). The Division may request these quotes either in unit prices or as lump sums; or
- b. If the work involved in the Change Order is not definable, the Division may request the work be performed on a time and material basis and include a maximum amount to be paid for the work. The method will be based on unit prices for both labor and materials agreed to by the Division prior to the Contractor commencing the work.

18.5 Disputes Regarding Change Order Prices

If the Contractor and the Division cannot agree on the cost of the work for a Change Order, using site-specific information including, but not limited to, Division historic public offer information, the Division will determine and set a fair price for the work and materials that are the subject of the Change Order.

PART 19: PAY ESTIMATES

19.1 General Information

Payments issued to the Contractor as the work progresses are not acceptance of any portion of the work not completed in accordance with the Scope of Work nor do such payments relieve the Contractor of liability with respect to any obligation or any expressed or implied warranties or responsibilities for faulty materials or workmanship.

19.2 Required Review by the Division

Prior to the submittal of each invoice, the Contractor and the Division must meet at the Project site to review the Project progress. The Contractor and the Division's Project Representative must mutually agree on quantity and percentage of work completed for all offer items prior to submittal of each invoice. No invoice will be approved for work that has not been approved by the Division's Project Representative. Field verification of all lump sum quantities and weight slips for all unit price quantities invoiced must be submitted to the Division's Project Representative for review during the meeting.

All Field Orders and/or Change Orders issued prior to an invoice must be signed/acknowledge by the Contractor for the Division to consider an invoice for approval.

The Contractor's payment must be submitted to the division via the Orphan Well Project Management Contractor Portal (<https://dnr-ow-prod.powerappsportals.us/>). The invoice must include back up documentation. The Division will confirm the invoice is accurate.

For Federally Funded Projects: The Contractor/Subcontractor shall submit payroll reports with each Invoice. Payroll reports shall be completed according to Part 3 of the **Davis-Bacon Requirements** included in the Scope of Work.

Invoices received by the Division containing errors or requesting amounts that cannot be approved will be returned to the Contractor. The Contractor may resubmit an invoice after correcting errors.

19.3 Documents to be Submitted for Payment

With each request for payment the Contractor certifies that:

- a. The request for payment is accurate as to materials and the work completed under the terms and conditions of the Scope of Work and any Change Order, as applicable, including full compliance with all labor provisions; and
- b. All subcontractors and material suppliers have been paid for the work or materials that are applicable to all previous invoices. As certification, each request for payment, at the Division's request, may need to be accompanied with a properly executed "Waiver of Liens" from all subcontractors and material suppliers to show that all previous payments made by the Division to the Contractor have been applied to fulfill, in full, all of the Contractor's obligations reflected in prior requests for payment.

19.4 Effect of Liens on Invoices

All work, materials, and equipment covered by any request for payment, whether incorporated in the Project or not, will pass to the Division at the time of payment free and clear of all liens, claims, security interests and encumbrances.

If there is evidence of any lien or claim that is chargeable to the Contractor, the Division will withhold all payments due to the Contractor to secure such lien or claim. If there are any previous liens or claims after payments are made to the Contractor, the Contractor may be required to refund to the Division a sum of money equal to the sum of all monies that the Division may be compelled to pay in discharging any lien or claim as a result of the Contractor's default.

PART 20: RETAINAGE FOR FINAL RESTORATION

If the Scope of Work requires revegetation of disturbed area, the Division will retain five percent (5%) of the sum of (1) the Offer amount and (2) all approved Change Orders. The five percent (5%) amount retained shall be released once the Division completes a Final Restoration Inspection and determines that vegetation has reached final stabilization. "Final stabilization" means vegetation established in a uniform perennial vegetative cover and meets all requirements listed in the Detailed Specifications under "Site Restoration". "Final stabilization" also means that no large barren areas exist, and the vegetation is of an equal or better condition than before the project started. The Contractor must remove all temporary erosion and sediment controls once final stabilization is achieved.

PART 21: REDUCED GAS EMISSIONS CREDITS

No one may directly or indirectly use the reduced gas emissions from wells plugged with State of Ohio funds or Infrastructure, Investment and Jobs Act funds, in whole or in part, to monetize, generate, or collect credits to include but not be limited to carbon, methane, or fugitive emissions, or otherwise use the plugging of wells funded with State of Ohio funds or with Infrastructure, Investment and Jobs Act funds to generate income of any type by offsetting their own or another party's gas emissions.



SCOPE OF WORK
Gallia 6F PROJECT
QUICKLE FARM
Gallia County, Springfield Township

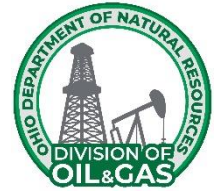

GENERAL SPECIFICATIONS

Unless there is a specific pay item in the Detailed Specifications, the work defined in the General Specification shall be incorporated into other items of work.

PART 1: HOURS OF WORK

The Contractor, the Contractor's agents, representatives, and subcontractors shall perform plugging projects during the days of Monday through Friday. Work will not be conducted on weekends or state/national holidays except with Division approval or during emergency situations. A workday is defined as eight (8) hours. However, additional hours may be worked with Division approval or during emergency situations.

PART 2: EQUIPMENT

The Contractor equipment shall pass all safety requirements of local, state, and federal agencies. The Ohio Department of Natural Resources, Division of Oil and Gas Resources Management reserves the right to inspect the equipment prior to the Recommendation of Award.

Unless otherwise noted, all equipment and materials required to complete the work described shall be provided by the Contractor.

PART 3: NOTIFICATIONS

3.1 Seven Working Day Notice

The Contractor shall log into the Orphan Well Project Management System (OWPMS) no less than seven (7) working days prior to commencement of work. Notice will be sent using the system and may be sent for each well that work will be started on at that time. This notice will allow the appropriate Division staff time to mark the approved access route and any sensitive areas that need to be left undisturbed.

The Contractor, the Contractor's agents, representatives, and sub-contractors shall contact each utility company that has utilities that directly affect plugging activities at the well location(s).

3.2 Public 48 Hour Notice

Prior to initiating well plugging operations, the Contractor shall give a minimum of 48-hour notice to the local fire department. Confirmation of this notification shall also be made to the Inspector or the Division Regional Office.

3.3 Emergency Notification

When emergency conditions are encountered, such as a release of hydrogen sulfide gas (H₂S), natural gas, crude oil, condensate, or brine that threatens human health, safety or the environment, as described in Ohio Administrative Code 1501:9-08-02, the Contractor shall notify the local fire

department, the Local Emergency Planning Committee (LEPC) and call the 24/7 incident notification number: 1-844-OH-Call1 (1-844-642-2551) within 30 minutes of the occurrence.

3.4 Plugging Completion Notice

No sooner than three business days after emplacing the uppermost plug, the Division will review the well to determine if any additional plugging work shall be required at that time. If additional work is needed, a Field Order will be issued by the Division. The Field Order shall state what must be completed and what, if any, Change Orders shall be required. If additional work is not needed the contractor shall cut the casing as defined in the Plugging Plan and set the plugged well identification as outlined in these **General Specifications** and Ohio Administrative Code 1501-9-11-10.

PART 4: ACCESS AND PRESERVATION OF SITE

All costs for the adequate access to the well site for the plugging equipment shall be included in the Offer. Unless waived, placement of all tanks and equipment shall be subject to Division's approval. If requested by the Division, access roads will be chained or cabled to prevent unauthorized use.

Special attention shall be given to maintaining trees and other vegetation that have scenic value, provide shade, reduce erosion and runoff, or add to the aesthetics of the area. No trees three (3) inches or larger in diameter shall be removed without the Division's permission. Any alterations to the natural topography required to provide ingress and egress to the well site must be approved by the Division before work begins.

PART 5: DAMAGE CAUSED BY CONTRACTOR

All damage caused by the Contractor's negligence in carrying out of this scope of work to any public or private property of any nature whatsoever, including trees, shrubs, and crops, shall be corrected to Division's satisfaction at the expense of the Contractor. If crops are damaged and the Contractor, landowner, or tenant cannot reach a settlement, the County Cooperative Extension Service shall set a fair price for crop damages and the decision shall be final and binding upon all parties. All subsequent payments due the Contractor shall be withheld until the Contractor provides proof of payment of any such claim.

The Contractor shall be responsible for all costs of repairing or replacing any survey monument that is disturbed or destroyed by the Contractor. The Contractor shall utilize a professional surveyor who is licensed and registered by the State of Ohio to perform the re-establishment of said monuments according to the standards set forth by the governing body or law of said monument. For the purpose of this scope of work, the term survey monument shall apply to any property boundary marker, federal, state or county geodetic benchmark, state, or county right of way monument, FEMA benchmarks or flood elevation markers.

PART 6: SAFETY

6.1 Public Safety Coordination Meeting

The Contractor shall hold a safety meeting with the County EMA, local fire department, Division Emergency Operations staff and Inspector, and other applicable contracting staff prior to commencement of plugging activities. The meeting shall review 1) the safety of the public during operations, 2) the safety of workers during operations, 3) emergency notifications of events, 4) site set up and layout, 5) general overview of operations, 6) nearest hospital's address and directions.

This meeting shall be led by the Contractor and is intended to be well specific. At the discretion of the Division, this requirement may be waived for the remaining wells should these wells be part of

the same lease\property.

6.2 Daily Safety Meetings

The Contractor shall hold a daily safety meeting for all personnel on-site prior to the commencement of work. The Contractor shall provide and maintain a sign in/out sheet for all people on location. The Contractor shall immediately report any accidents and/or safety concerns to the Inspector.

6.3 Operational Standards

The Contractor shall follow the rules established by Occupational Safety and Health Administration (OSHA) Safety and Health Regulations for Construction 29 CFR 1926 and OSHA General Industry 29 CFR 1910 on all onsite project operations.

6.4 Excavation and Trenching Requirements

The Contractor shall follow the notification protocol as specified in Part 3 of the General Specifications before the start of any excavating activities. The Contractor will comply with OSHA Construction Standards for excavation and trenching under 29CFR 1926 Subpart P.

6.5 Hazardous Communications Requirements

The Contractor shall maintain Safety Data Sheets (SDS) for all chemicals stored and/or used. SDS sheets will be stored onsite with the Emergency Response Plan (ERP). A copy of SDS sheets and the ERP will be stored at the project entrance in a container labeled "ERP/SDS". A copy of all SDS will be supplied to the local Fire Department and/or to the Division when requested.

6.6 Site Security

The Contractor shall provide and install protective barriers/fencing around the work area to prevent unauthorized access. Ingress and Egress access must be maintained at all times.

6.7 Wind Direction Indicator

The Contractor shall install a windsock in an open area of the well location where it is visible to all onsite personnel. It shall be constructed of high visibility material and deployed no less than six (6) feet above grade during the plugging operations.

6.8 Muster and Smoking Areas

The Contractor shall mark and assign a primary and a secondary muster area daily upwind of the well location. These are to be determined based on prevailing wind direction, as indicated by the windsock. The Contractor will establish a safe location for a designated smoking area.

6.9 Ignition Sources and Parking Areas

The Contractor shall identify and mark all potential ignition sources within a 50-foot radius of the well. The Contractor shall mitigate or remove as many ignition sources as possible from the working area. The designated parking area will be outside the 50-foot radius from the well.

6.10 Air Monitoring and Worker Safety

The Contractor shall supply and place a 4-gas monitor at the wellhead. The gas monitor must be calibrated and maintained to monitor Methane (CH₄), Oxygen (O₂), Carbon Monoxide (CO) and Hydrogen Sulfide (H₂S).

Stop work must be followed when any of the levels listed below occur:

- Methane - 1000 parts per million (ppm)/2% Lower Explosive Limit (LEL),
- Oxygen - saturation below 19.5% or above 23%,
- Carbon Monoxide – 50 ppm,
- Hydrogen Sulfide – 10 ppm.

The levels stated above are directly from the Occupational Safety and Health Administration (OSHA) and The National Institute for Occupational Safety and Health (NIOSH) and are standard for air monitoring procedures for safety and work environments. If any of the above levels are alarmed, all personnel will shut down ignition sources and report to the muster area.

Division Emergency Operations personnel or the Inspector has the right to stop work if the actions are unsafe or the actions cause or are likely to cause danger to the workers, public, or the environment.

PART 7: MAINTENANCE OF TRAFFIC

The Contractor shall at all times install, maintain, and operate all traffic and traffic control devices in conformance with the requirements of the "Ohio Manual of Uniform Traffic Control Devices for Streets and Highways," hereinafter called The Ohio Manual.

The Contractor shall notify the appropriate public officials and the Division and shall obtain all required permits prior to any lane closure of a public road.

The Contractor shall maintain ingress/egress to all properties associated with the project at all times during the project unless agreed upon in writing by the Division and the landowner.

7.1 STREET CLEANING

The Contractor shall be required to provide street cleaning services in order to remove sediment/debris tracked from the construction site/access drive onto private or public roadways during all phases of the Project.

The Contractor shall work diligently to minimize the amount of sediment tracked onto roadway. The Contractor will conduct all construction and ingress/egress operations in conformance with Part 9: Erosion and Sediment Control of the General Specifications. Use of other erosion and sediment control measures to prevent sediment runoff during period of rains and non-working hours.

The Contractor will provide street cleaning, such as sweeping or vacuuming, at locations around the project ingress/egress where plugging operations has caused tracking of sediments onto roadways. Mechanical sweepers shall be vacuum-type or regenerative sweepers. Sweeping speed will not exceed 6 mph. A minimum of two passes shall be made. Streets must be cleaned daily before the end of the workday. If excess sediments have been tracked onto the streets or if rain is expected, the Division may direct the Contractor to clean the street as often as necessary to keep the street clean at all times.

The Contractor shall be required to remove and dispose of sediments properly. Removal of collected sediment deposits will be disposed on the project site. If sediment deposits cannot be disposed of on-site, an alternative location will be approved by the Division. No offsite disposal will be in or adjacent to a stream and/or floodplain. Sediments to be placed at the project site will be in conjunction with site restoration and should be spread, compacted, covered, and stabilized in accordance with the site restoration line item. **Sediment will not be allowed to flush into stream or drainage way and washing or flushing of sediments into adjacent drainage systems is prohibited.** If sediment has been contaminated, it will be disposed of in accordance with the contaminated material disposal line item.

The cost of this work shall be included in Contract bid prices for items of which this work is a component.

PART 8: PROTECTION OF EXISTING UTILITIES

Before construction begins, the Contractor, acting as an agent for the Division, shall locate all utilities in the vicinity of the work. The Contractor shall be responsible for complying with the regulations pertaining to utilities in the State of Ohio. The Contractor shall assume all risk for all utilities located in the vicinity of the work, whether above or below the surface of the ground. The Contractor shall also be responsible for all damages and assume all expense for direct or indirect injury, caused by his work, to any of the utilities, or any person or property by reason of injury to them, whether such utilities are or are not shown on the drawings, once they have been uncovered by the work. **In compliance with Ohio Revised Code 3781, two working days before digging the Contractor shall contact the Ohio Utility Protection Service (OUPS) and Oil and Gas Producers Underground Protection Service (OGPUPS) using the Ohio811 one call service by calling 811 or by using the i-dig login found on the internet at OHIO811.org. The Contractor shall maintain a current OUPS/OGPUPS call ticket during the entire project.**

PART 9: EROSION AND SEDIMENT CONTROL

Temporary erosion control measures are required during the course of this project. These measures may consist of the installation of straw bale dikes, silt fence, filter socks, inlet protection structures, erosion control blankets, energy dissipation, and temporary seeding and mulching.

Once construction begins, the Contractor shall be solely responsible for all construction related to the control of off-site sedimentation. This sediment shall be removed by the Contractor at the Division's direction.

9.1 Temporary Measures

Temporary erosion control structures shown on the Drawing Plan Set, identified with these specifications, or as directed by the Division shall be placed as soon as construction starts and must be maintained during the course of the project. At the direction of the Division, the Contractor shall remove the temporary controls when they are no longer needed or when required permanent control measures have been completed.

If sediment escapes the site, accumulations must be removed at a frequency to minimize further negative effects, and whenever feasible, prior to the next rain event.

The contractor shall be responsible for revegetation of all areas in which sediment escapes the site. These areas shall be included in the final stabilization of the project and shall be at the cost of the contractor.

9.2 Maximum Exposed Areas

Stabilization measures must be initiated as soon as practicable in portions of the site where construction activities have temporarily or permanently ceased, and except as provided below, must be initiated no more than seven (7) days after the construction activity in that portion of the site has temporarily or permanently ceased.

Where the initiation of stabilization measures by the seventh day after construction activity temporarily or permanently ceased is precluded by snow cover, or frozen ground conditions, stabilization measures must be initiated as soon as practicable.

Where construction activity on a portion of the site is temporarily ceased, and earth-disturbing activities will be resumed within fourteen (14) days, temporary stabilization measures do not have to be initiated on that portion of site.

The Division may limit the area of excavation, borrow and embankment operations in progress commensurate with the Contractor's capability and progress in keeping the finished grading, re-soiling, mulching, seeding and other such permanent control measures current in accordance with the acceptable schedule.

9.3 Winterization

When an incomplete project will be left exposed throughout the winter season, the Contractor shall furnish the Division a plan indicating the control measures to be installed and maintained until the next construction season.

If the winter period falls within the anticipated construction period of the Scope of Work and as indicated in the original approved construction schedule, control structures will be paid for by the Division at the unit prices in the Offer.

If the project is not substantially completed prior to the winter season due to the failure of the Contractor to meet the completion date, these necessary control structures will be installed and maintained by the Contractor at his expense and these items will not be paid for under the terms of the Scope of Work, except those that are permanent facilities to be left in place in accordance with the Drawing Plans Set and Specifications.

9.4 Other Controls

Off-site vehicle tracking of sediments and the generation of dust must be minimized, and any waste must be properly disposed.

9.5 Inspections

The Division Inspector shall conduct inspections to ensure that the control practices are functional and to evaluate whether the erosion and sediment control measures are adequate and properly implemented.

9.6 Enforcement

The Division shall take appropriate steps to ensure that sedimentation does not leave the project site. The Division shall require the removal of off-site sediment by the Contractor if such sediment resulted from the Contractor's negligence to place and maintain sediment control structures in

accordance with the Drawing Plan Set and Specifications.

PART 10: SPILL PREVENTION AND REMEDIATION

The Contractor is expected to prevent and, if necessary, contain and remediate any spills that may occur at the site due to plugging activities. All stationary plugging equipment on well locations that are in tiled farm fields, residential neighborhoods, parks, or in/adjacent to areas determined by the Division to be environmentally sensitive, will be staged on an impermeable liner and berm. **The Contractor will have oil absorbent pads and booms available onsite during the plugging operations.**

PART 11: HYDROGEN SULFIDE

If the well that is being plugged is known to produce hydrogen sulfide (H₂S), the following considerations must be observed:

- A. The Contractor must provide the appropriate equipment, on-site, to properly detect and abate any H₂S emitted from the well. If the Contractor does not have the appropriate equipment to properly detect and abate any H₂S emitted from the well, they will utilize an appropriate party to provide these services.
- B. The Contractor will shut-in the well each night after the plugging operations have ceased, unless otherwise instructed by the Division. The Contractor will continue this process until the plugging operations are complete and there are no further signs of a gas release.

PART 12: CASING

The Division reserves the right to require the removal and or placement of any tubing, casing, or liners deemed necessary to properly plug and abandon the well. If a string of casing that would normally be pulled cannot be removed, the Contractor may be required to log the well and perforate the casing, in accordance with the Division's instructions, so that cement can be circulated behind the casing.

The Contractor shall run an operational string of casing when caving of the well prevents clean out to depth required in the scope of work.

PART 13: DEFINITIONS

13.1 Clean Out

The process in which the contractor would use a smaller diameter tubular to circulate out material from inside a larger diameter wellbore/tubular. This shall include removing mud-laden fluid, prepared clay, bridge plugs (e.g. brush and stone plugs, surface debris), and wellbore cave-in (e.g. swelling shales, red clays). Equipment needed includes, but is not limited to, tubing, a mud pump, a power swivel/power sub or a tubing swivel, a drill bit with the jets removed and/or a notched collar. *A positive displacement mud pump with the capacity of pumping at least 3 barrels per minute and able to overcome hydrostatic head is required for this process.*

13.2 Drill Out

The process in which the contractor would use a drill string, associated fittings, and a bit to remove an obstruction from inside of the wellbore or casing. This shall include removing cement, grout, wood plugs, or other materials in which a cleanout operation failed to remove. Equipment needed includes, but is not limited to, a mud pump, power swivel/power sub, drill string (including collars

and casing or tubing), cross over subs, bit sub, and drill bit. *A positive displacement mud pump with the capacity of pumping at least 3 barrels per minute and able to overcome hydrostatic head is required for this process.*

13.3 Wash Over

A process in which the contractor would use an intermediate size working string of casing, usually equipped with a carbide coated collar on the bottom joint, to run down over the smaller well tubular and clean out the annular space between the well tubulars. This process would include utilizing a power swivel or power sub to rotate the working string of casing and a mud pump to circulate fluid down between the working string and the outside of the smaller well tubular to wash out the material in the annular space between the well tubulars. This shall include removing mud-laden fluid, prepared clay, cement, grout, field packers, and surface debris. When needed, a wash over bit shall be attached on the bottom of the larger casing to act as a cutting edge for the material on the backside of the tubular being washed over. *A positive displacement mud pump with the capacity of pumping at least 3 barrels per minute and able to overcome hydrostatic head is required for this process.*

13.4 Milling

The process in which the contractor shall use a drill string and bit to remove a metal obstruction from inside of the wellbore or casing. Equipment needed includes, but is not limited to, a mud pump, power swivel/power sub, drill string (includes collars and casing or tubing), cross over subs, bit sub, and mill. The mill type would depend on the material encountered. *A positive displacement mud pump with the capacity of pumping at least 3 barrels per minute and able to overcome hydrostatic head is required for this process.*

13.5 Fishing

The process in which the contractor shall use a specialized tools or fishing tool to eliminate an obstruction from inside of the wellbore or casing. Equipment needed includes, but is not limited to, a fishing tool(s) and fishing string.

13.6 Bail & Grout

The process the contractor shall use when determined that the wellbore can be bailed of all fluid, and grouted. Equipment needed includes, but is not limited to, tubing, a bailer, and a grout pump. Grout shall be gravity feed to the bottom. This can be done in one application or in stages, depending on the well depth and condition. If the well cannot be bailed completely dry the contractor shall use a siphon string/tremie tube to remove the water from the well during grout application.

PART 14: WELL OBSTRUCTION ASSESSMENT

If an obstruction is encountered in the well bore that prevents the Contractor from reaching total depth, the Contractor will attempt to identify/assess the nature of the obstruction and attempt to remove any obstruction deemed an impediment to the plugging operation. **The Contractor will supply impression blocks as part of their normal rig equipment.**

PART 15: REMOVAL OF AN OBSTRUCTION

The removal of an unknown obstruction that is encountered during the cleanout of a well may require the use of milling and/or fishing tooling and equipment. The Contractor will include the costs for these services on the appropriate line items in the contingency section of this offer unless these costs are part of a planned procedure. The Division will approve a method for the Contractor to remove the well obstruction. The Division will first utilize contingency specifications and line items to define this work. **The Division will not be responsible for milling or fishing charges that are due to Contractor negligence or Contractor equipment failure.**

PART 16: PLUGGED WELL IDENTIFICATION

In compliance with Ohio Administrative Code 1501:9-11-10, a steel plate, a minimum of ¼-inch thick, shall be tack welded on top of all plugged wells. The well's permit number and "ODNR" shall be welded on the plate in numbers/letters as large as practical. Letters shall have a minimum relief of 1/8-inch.

PART 17: TOILET FACILITIES

Where there are no readily accessible public toilet facilities, the Contractor will provide a portable field toilet on the location during plugging operations.

PART 18: COMPLETION, GUARANTEES AND WARRANTIES

Upon completion of the work described in the Project SOW, the Contractor shall request a Final Restoration Inspection be performed by the Division. The Division shall inspect the Project site(s) for completeness and acceptance against the Project SOW, and if the Division determines necessary, develop a list of incomplete and unacceptable work and conditions to be corrected by the Contractor. The Division will reinspect the Project site(s) until the Division determines all work described in the Project SOW is complete and acceptable.

The Contractor warrants (represents) that their work will be conducted in accordance with the standards described in the Project SOW (i.e., the SOW Detailed Drawings and Specifications) and that the Contractor's work be free of defects. Contractor guarantees their work and materials for a Warranty Period of one year, unless otherwise stated as a special provision of the SOW Detailed Specifications. The one-year Warranty Period commences on the date of inspection on the Final Restoration Inspection form that accepted the work.

Should defects develop with the Contractor's work or materials within the Warranty Period, the Contractor shall, upon written notice of the Division, remedy the defects and any associated disturbance at their own expense. If the Contractor, after receiving the Division's notice, does not remedy the defects to the satisfaction of the Division, the Division may proceed against the Contractor as prescribed by the Department of Administrative Services (DAS), Index Number MAC110. All representations, warranties, and guarantees made in the DAS Index Number MAC110 contract and the Project SOW shall survive final payment and termination or completion of this Contract.



SCOPE OF WORK
Gallia 6F PROJECT
QUICKLE FARM
Gallia County, Springfield Township

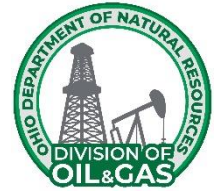

SEQUENCE OF WORK

General: Performance of all work shall be coordinated with the Division of Oil and Gas Resources Management (“Division”) Orphan Well Inspector (“Inspector”). The Sequence of Work shall be repeatable for all the project’s wells. **Work ahead of service rig mobilization shall be at the discretion of the Division.** Work shall not be initiated prior to fourteen (14) days ahead of rig mobilization, **unless approved in writing by the Division.**

The Sequence of Work for the Orphan Well Project shall be as follows:

Phase I:

- 1) Contact the Ohio Utility Protection Service and the Ohio Oil & Gas Producers Underground Protection Service.
- 2) Coordinate with the Orphan Well Inspector and the local authorities for the mobilization of equipment over the roads and bridges to the site as applicable.
- 3) Verify with the Orphan Well Inspector that the pre-construction staking (i.e. Construction Work Limits) has been completed by the Division. **The pre-construction staking must be completed prior to mobilization.**

Phase II:

- 1) Mobilize all necessary equipment to the site and develop the site access as shown on the **Drawing Plan Set.**
- 2) Implement site safety and secondary containment as described in the **Detailed Specifications.**
- 3) Install perimeter sediment controls as required by the Division.
- 4) Prepare the well for plugging as described in the **Detailed Specifications, “Well Head Control.”**
- 5) Upon successful installation and approval of the wellhead and establishment of well control, the Contractor shall begin to plug the well as described in the **Plugging Plan and Detailed Specifications, “Well Preparation & Plugging.”**
- 6) **No sooner than three (3) business days after placing the uppermost plug, the Division will inspect the well at surface to determine if any additional plugging work shall be required at that time. If additional work is not needed the Contractor shall cut the casing as defined in the Plugging Plan.**
- 7) The Contractor shall set the plugged well identification as outlined in the **General Specifications**

and Ohio Administrative Code 1501-9-11-10.

Phase III:

- 1) Within three (3) working days after Division has determined the plugging operations are completed, the Contractor shall remove all well and well plugging-related equipment, fluids, and cuttings from the site. The Contractor shall also excavate and remove all contaminated soils present onsite if present.
- 2) Within fourteen (14) days after the completion of the plugging operations, the Contractor shall reseed as applicable, final grade, disc, fertilize, seed, and mulch all disturbed areas. **If work cannot be complete due to the season or weather conditions, the site shall be winterized per the General Specifications, Part 9 Erosion and Sediment Control and the site restoration shall be scheduled for completion.**
- 3) All reclamation shall be finished to an equal or better condition than what existed prior to construction. The Division shall give the final approval for the restoration of the site.



SCOPE OF WORK
GALLIA #6F PROJECT
Quickle Farm #1 Well Site
Gallia County, Springfield Township

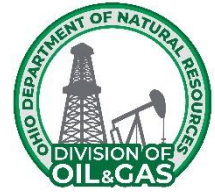

WELL DESCRIPTION

This Well Description is for:

Quickle Farm #1, 34-053-9-0012-00-00, Gallia County, Springfield Township

Background: The Quickle Farm #1 is located on a 28-acre parcel (02800176900) owned by Haskell and Nisa Spurlock. The address is 90 Vale Rd, Bidwell, OH 45614.

The well was brought to the attention of the division by the landowner. Division inspection noted the well to be open 10-inch casing with possible plugging material at the surface, and it had gas and fluids bubbling from the casing. In 2025, a UPC work contract noted the 10.75-inch casing with material inside but was unable to safely install wellhead control. Contaminated materials were removed from around the wellhead and a 48-inch corrugated HDPE riser was installed around the well.

Ohio Fuel Gas map information states the Quickle Farm #1 was drilled to 1,751 feet and completed open hole in the Berea sandstone.

There are no casing records for the Quickle Farm #1; however, an offset well the Hoffert #1-29 (34-053-2-0586-00-00), located approximately 4,400 feet to the Southeast was drilled in 1980 to a depth of 3,880 feet and produced out of the Queenston sandstone.

Formation data for the Quickle Farm #1, 34-053-9-0012-00-00 was transcribed directly from the OFG map and is reflected below:

Formation	Top	Bottom	Remarks
1 st Cow run sandstone	389	400	
2 nd Cow run sandstone	500	511	
Maxburg 800	800	875	Gas @ 800 feet
Keener sand	1,179	1,200	
Big Injun sandstone	1,210	1,230	
Squaw	1,240	1,247	
Stray sand	1,420	1,437	
Berea sandstone	1,655	1,668	Show of Oil
Total Depth		1,710	

Casing data for the Hoffert #1-29, 34-053-2-0586-00-00 shows the following:

- 13-inch conductor set at 83 feet with 100 sacks
- 8.63-inch surface casing set at 1,545 feet with 325 sacks
- 4.5-inch production casing set at 3,870 feet with 150 sacks

For the purposes of this scope of work, it is assumed that Quickle Farm #1 was drilled to a total depth of 1,710 feet and originally produced from the Berea sandstone and is equipped with 83 feet of 10.75-inch surface casing.

The deepest underground source of drinking water (USDW) is not mapped in this area. Based on local water well data, offset oil and gas well records within the reviewed area, and published groundwater resources information for Gallia County, the bedrock consists of alternating layer of Shales and thin Sandstones. The primary aquifer can be found in interbedded sedimentary rock. Water well depths vary wildly from 60-120 feet and produce less than 15 gallons per minute.

According to the Division of Mineral Resources Management, there are no mines located in the area of review.

Scope of Work: This project includes the mobilization and access to the site, plugging the orphan well, as well as regrading of disturbed areas as described.

Designated Route: The contractor shall utilize Vale road to access the site during all phases of the plugging operations.

It is the Contractor's responsibility to contact all County, Township, State and Municipal Officials having jurisdiction over the roads that are intended to be utilized for this project. The Contractor shall provide written documentation to the Division, of all road use notifications/approvals prior to mobilizing equipment to the site.



SCOPE OF WORK
GALLIA #6F PROJECT
Quickle Farm #1 Well Site
Gallia County, Springfield Township

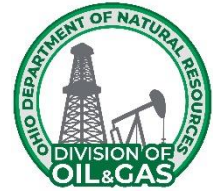

PLUGGING PLAN

This Plugging Plan is for:

Quickle Farm #1, 34-053-9-0012-00-00, Gallia County, Springfield Township

For the purposes of this scope of work, it is assumed that Quickle Farm #1 was drilled to a total depth of 1,710 feet and originally produced from the Berea sandstone and is equipped with 83 feet of 10.75-inch surface casing.

The Contractor shall maintain a minimum of 100 barrels of 9 pound-per-gallon weighted brine on location throughout the entire plugging process for use as a well kill fluid.

- 1) The Contractor will safely relieve any pressure that may be built up on this well prior to commencing plugging operations. The Contractor will give the property owners and local fire authorities a minimum of twenty-four (24) hour notice prior to blowing down the well.
- 2) The Contractor shall then install an appropriately sized and lined temporary cellar around the wellhead to capture any fluids generated during the plugging process.
- 3) The Contractor shall visually examine the existing casings, to evaluate their condition immediately below grade. If the casing is found to be severely degraded, the Contractor will remove the incompetent section of casing and install enough new casing, of similar diameter, to bring the top of the existing casing to a suitable working height.
- 4) The Contractor shall then install an appropriate wellhead and an approved method of well control on the most appropriately sized casing string to insure there is control of any gas and/or fluids generated from the well. **The Contractor shall establish and maintain well control throughout the entire plugging process.**
- 5) The Contractor shall clean out the material in the well bore to a depth of 280 feet or another depth approved by the Division. The Contractor shall provide up to 260 barrels of freshwater on location for use as circulation fluid.
- 6) The Contractor shall then run new 7-inch OD surface casing to 250 feet, or a depth approved by the Division. This casing shall be equipped with stabilizers and a float shoe on the bottom joint. The Contractor shall then cement the annulus of this casing to surface with an approved cement, mixed at 15.6 pounds per gallon. The Contractor shall wait on the cement for a minimum of eight (8) hours.
- 7) If a successful surface casing cement job is not achieved the contractor shall load the surface casing with fresh water and run a Bond log and CCL to verify top of cement and determine remedial actions before drilling out the shoe.

- 8) The Contractor shall then install an appropriate wellhead and an approved method of well control on the most appropriately sized casing string to insure there is control of any gas and/or fluids generated from the well. **The Contractor shall establish and maintain well control throughout the entire plugging process.**
- 9) The Contractor shall then drill out the float shoe and clean out the wellbore to a depth of 1,710 feet or a depth approved by the Division. The Contractor shall provide up to 260 barrels of freshwater on location for use as circulation fluid.
- 10) All cement plugs shall be set through a working string of 1.5-inch minimum inside diameter (ID) tubing using an approved cement with 2% Calcium Chloride, mixed at 15.6 pounds per gallon. **The well shall be in a static condition prior to beginning any cementing activities.** In addition, circulation must be established, and all free crude oil shall be circulated from the wellbore prior to setting any plug. **A minimum of ten (10) barrels of gel is required to be run ahead of each cement plug that may come into contact with open hole formations.**
- 11) The Contractor will set a 450-foot bottom hole cement plug from 1,710 feet to 1,260 feet to cover the Berea sandstone. The Contractor will wait on cement for a minimum of eight (8) hours and then run their tools into the well to verify the depth to the top of the plug. If the plug has dropped or it is determined that a competent plug has not been achieved, additional plugs may be required at the discretion of the Division.
- 12) The Contractor will set a 225-foot cement plug from 925 feet to 700 feet to cover the Maxburg sandstone. The Contractor will wait on cement for a minimum of eight (8) hours and then run their tools into the well to verify the depth to the top of the plug. If the plug has dropped or it is determined that a competent plug has not been achieved, additional plugs may be required at the discretion of the Division.
- 13) The Contractor will set a 300-foot cement plug from 700 feet to 400 feet to cover the 2nd Cow Run sandstone. The Contractor will wait on cement for a minimum of eight (8) hours and then run their tools into the well to verify the depth to the top of the plug. If the plug has dropped or it is determined that a competent plug has not been achieved, additional plugs may be required at the discretion of the Division.
- 14) The Contractor will set a 250-foot cement plug from 400 feet to 150 feet to cover the bottom of the 7-inch diameter surface casing. The Contractor will wait on cement for a minimum of eight (8) hours and then run their tools into the well to verify the depth to the top of the plug. If the plug has dropped or it is determined that a competent plug has not been achieved, additional plugs may be required at the discretion of the Division.
- 15) The Contractor will set a cement plug from 150-feet to within thirty (30) inches of ground level, wait on cement a minimum of eight (8) hours and top off with additional cement if necessary. Any open annular voids present at the surface shall be filled with cement.
- 16) No sooner than three (3) business days after placing the uppermost plug, the Division will inspect the well at surface to determine if any additional plugging work shall be required at that time. If additional work is not needed the Contractor shall cut to a depth of 30 inches below the surface and the Contractor shall set the plugged well identification as outlined in the General Specifications and Ohio Administrative Code 1501-9-11-10.



SCOPE OF WORK
Gallia 6F PROJECT
QUICKLE FARM
Gallia County, Springfield Township

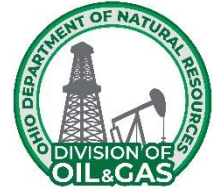

DETAILED SPECIFICATIONS

The Contractor is reminded to review the Scope of Work documents carefully. Coordination, permission, or direction of the Division may be required for use of individual Detailed Specification line items. The Division shall only pay for quantities of items that are correctly installed and completed in accordance with the Detailed Specifications and Drawing Plan Set. The Division shall not guarantee payment of any work completed without or prior to following the conditions described herein of each line item.

MOBILIZATION

- A. **Description:** This work shall consist of the development of access and the mobilization of the Contractor's forces and equipment necessary for performing the required work under the Scope of Work for the well site.

This item shall include the transportation of personnel, equipment, and supplies to and from each site as well as the maintenance of all onsite access roads.

As part of this line item, the Contractor shall also include any maintenance of traffic required within the road right-of-way per Part 7 of the General Specifications.

Also, the Contractor shall be responsible for cleaning mud and dirt associated with construction from all roadway surfaces (public and private) as per Part 7.1 of the General Specification for the duration of the Project and as directed by the Division.

- B. **Execution:** No additional compensation shall be made to the Contractor for remobilization after his equipment has been removed from the site. If applicable, this shall include remobilization of equipment if removed due to winterization of the project.

Any damage to the road, drives, and/or culverts caused by the mobilization shall be repaired by the Contractor at the Contractor's expense. All repairs shall be done equal to or better to that which existed prior to construction activities.

- C. **Measurement:** Measurement for payment will be considered and measured as a unit satisfactorily completed and accepted by the Division.

If any portion of the item is non-performed to the satisfaction of the Division (i.e., the mud and dirt are not cleaned from the roadway, the proper signage is not used as detailed) this is considered unsatisfactory and shall be cause for the rejection of payment of this item.

As part of the consideration to be satisfactorily completed, work shall be per the

“Sequence of Work.”

- D. Payment: The cost of this work shall be included in the lump sum price for "**Mobilization.**"

DEMOBILIZATION

- A. Description: This work shall consist of the demobilization of all personnel, plugging related equipment and materials as well as the cleanup of all areas upon completing all other work required under the scope of work for the well site.
- B. Execution: Any damage to the road, drives, and/or culverts caused by the demobilization shall be repaired by the Contractor at the Contractor's expense. All repairs shall be done equal to or better to that which existed prior to construction activities.

This item shall also include the continued and proper use of any maintenance of traffic required within the road right-of-way per Part 7 of the General Specifications.

Also, the Contractor shall be responsible for cleaning mud and dirt associated with construction from all roadway surfaces (public and private) as per Part 7.1 of the General Specification for the duration of the Project and as directed by the Division.

- C. Measurement: Measurement for payment will be considered and measured as a unit satisfactorily completed and accepted by the Division. **Demobilization of equipment between wells shall be considered incidental to this line item for wells using a common entrance.**

If any portion of the item is non-performed (i.e., the mud and dirt are not cleaned from the roadway, damaged items not restored to the satisfaction of the Division, etc.) this is considered unsatisfactory and shall be cause for the rejection of payment of this item.

- D. Payment: The cost of this work shall be included in the lump sum price for "**Demobilization.**"

CLEARING & GRUBBING

- A. Description: This item covers the removal of the vegetation within the limits shown on the Drawing Plan Set to provide adequate space to maneuver equipment to complete the proposed work at each well.
- B. Execution: The Contractor shall only clear enough of the site within the limits shown on the Drawing Plan Set to provide adequate space to maneuver equipment to complete the proposed work. The Division shall exercise control over clearing and shall designate all trees, plants, shrubs, abandoned material, trash, etc., to be removed or to remain. This work shall also include the preservation from injury or defacement of all trees designated to

remain.

If the Contractor clears and/or grubs beyond the construction work limits, whether knowingly or accidentally, the Contractor shall replant and/or otherwise restore all areas outside of the limits to a condition equal to or better than what existed prior to beginning work. This shall be no at no additional expense to the Division.

All tree disturbance (trimming and/or removal) activities shall be coordinated with the Division as these trees may provide suitable roosting, foraging, or traveling habitat for Threatened & Endangered species. To prevent adverse impacts to Threatened & Endangered species, clearing of trees with a DBH (Diameter at Breast Height) greater than 3inches, **shall not take place between April 1st and September 30th.**

All removed vegetation shall be placed in a stable manner. **Brush and debris shall be stacked to the down slope side of the work, outside of the work limits.** The Division shall make the final determination as to the stability and location of the constructed piles. The log pile(s) shall not exceed four (4) feet in height or eight (8) feet in width, and thirty (30) feet in length. The Contractor shall be responsible for the repair/reconstruction of the piles, at the discretion of the Division, up to the final acceptance of the project.

As directed by the Division, Stumps shall be cut off flush with the existing ground surface prior to placement of material or grubbed, and holes graded to assure positive drainage. Approved resoil shall be used if the area can't be properly graded.

Burning of debris materials shall not be permitted on-site.

- C. Measurement: Measurement for payment will be considered and measured as a unit satisfactorily completed and accepted by the Division. This measurement shall be for the entire project as one unit.
- D. Payment: Payment shall be made at the contract lump sum price per "**Clearing & Grubbing.**"

SILT FENCE

- A. General: This item covers construction of silt fences and/or straw bale dikes. The Division shall designate utilization of silt fence, straw bale dikes or a combination of both at locations selected for placement.

The placement of silt fence and straw bale dikes within the limits of construction shall be at the discretion of the Division.

During the life of the project, the Contractor shall maintain these silt and erosion-control structures. Accumulated silt shall be removed when it, in the Division's opinion, may damage or reduce the effectiveness of the structure.

B. Straw Bale Dikes

1. Materials: Straw bale dikes shall be constructed with twine-bound square straw or hay bales, staked to remain in place.
2. Installation and Execution: The location of the dikes shall be as directed by the Division, at the time of construction. When the usefulness of the dikes has ended, they shall be removed and disposed of. Dikes may remain in place upon completion of the project only when permitted by the Division.

C. Silt Fence

1. Materials

- a. The silt fence fabric shall conform to the ODOT Item 712.09, Type C. The silt fence shall be installed in accordance with all manufacturers' instructions.

The fabric shall be free of any treatment that might significantly alter its physical properties. During shipment and storage, the fabric shall be wrapped in a heavy-duty protective covering to protect it from direct sunlight, dirt, and other debris.

The manufacturer shall submit certified test data to cover each shipment of material.

- b. The silt fence used shall be a prefabricated silt fence with fabric already attached to posts or shall be assembled in the field according to the following installation guidelines.

The fabric shall be a pervious sheet composed of a strong, rot-proof polymeric yard or fiber oriented into a stable network, which retains its relative structure during handling, placement, and long-term service. It shall have excellent resistance to deterioration from ambient temperatures, acid, and alkaline conditions, and shall be indestructible to microorganisms and insects. The material shall be resistant to deterioration by ultraviolet light and protected until placement as recommended by the manufacturer such that no deterioration occurs. During shipment and storage, the rolls of fabric shall be protected against deterioration from the sun, mud, dirt, dust, and other harmful conditions at all times until their use.

2. Installation Guidelines for Silt Fence: Silt fence shall be installed in the following manner.

- a. First, a small toe-in trench shall be dug along the line where the silt fence is to be placed. The trench shall be a minimum of 6-inch deep and 6-inch wide. The excavated material shall be placed on the front or uphill side of the trench to facilitate backfilling later.
- b. Next, fence posts shall be driven into the back or downstream side of the trench. The posts shall be driven so that at least one-third (1/3) of the height of the post is

in the ground. When installing a prefabricated silt fence with fabric attached to the posts, the posts shall be driven so that at least 6-inch of fabric shall be buried in the ground. Most prefabricated silt fences have posts spaced approximately 6 feet – 8 feet apart, which is usually adequate. If there is a low spot where most sediment tends to collect, the prefabricated silt fences can be backed up with bale backup. Posts shall be hardwood with sufficient strength to support a full load of deposited sediment.

- c. Finally, the trench shall be backfilled with the excavated material and tamped so that at least 6-inches of the fabric is securely toed into the ground to prevent undermining.
 - d. The silt fences shall be maintained throughout construction. The Contractor shall conduct regular inspections and after all heavy rains. Damaged fences must be repaired immediately.
 - e. At the completion of construction and upon establishment of suitable vegetation as determined by the Division, all silt fence structures shall be removed. Areas disturbed by the removal operation including temporary access roads shall be revegetated. In general, this operation shall consist of regrading, re-fertilizing, reseeding, and mulching.
- D. Measurement: Measurement for payment for the above-described work shall be made by actual field measurements of quantities satisfactorily installed and completed. When using silt fence with bale backup the measurement shall be the length of the silt fence installed, plus the length of the straw bale dike installed.
- E. Payment for Silt Fence and Straw Bale Dikes: Payment for this item shall be made at the unit price per linear foot of "**Silt Fence.**" The Division shall only pay for quantities of items that are completed.

No. 4 STONE

- A. Description: This work covers the quality, material placement and requirements as a base course stone for project access as shown in the Drawing Plan Set.
- B. Materials: The materials shall consist of sound and durable rock, gravel or stone of the proper gradation meeting ODOT specifications. The material shall be free from cracks, seams, and other defects, which tend to increase deterioration from natural causes. It shall be highly resistant to weathering and disintegration under freezing and thawing and wetting and drying as evidenced by laboratory tests and/or service records. The Division at any time during the project may reject any materials, at the source or job site, not meeting the requirements of these specifications.

Acceptability of material will be determined by laboratory tests, visual inspection and/or service records as required by the Division. Service records will include documentation to show the material has performed satisfactorily on similar structures.

- C. Installation: Upon delivery of the material to the site the Contractor shall install the material in place as directed by the Division. The Contractor shall not stockpile materials at the site.

The Contractor shall remove the topsoil prior to installation of any access road or work area stone. Topsoil shall be stockpiled adjacent to the location it is removed from. At the conclusion of the project, all topsoil will be replaced to its original location as part of the line item "**Site Restoration.**" **Existing drives upgraded for the purpose of this work shall be restored to a condition better than prior to construction.**

- D. Measurement: The material shall be measured for payment by the ton (2,000 pounds) for material acceptably placed in the work area as determined by certified scale weight tickets.

All material wasted or used by the Contractor for other purposes and any material not placed in the work area in accordance with the requirements of the work order and these specifications and drawings shall be measured and not included for payment by weight. A conversion factor of 1.5 ton per cubic yard of No. 4 Stone shall be used if necessary.

- E. Payment: Payment of this work as specified above shall be made based on the unit price per ton for "**No. 4 Stone.**"

No. 57 STONE

- A. Description: This work covers the quality, material placement and requirements as a top course stone for the access drives as shown in the Drawing Plan Set. This material shall be placed within the current limits of the landowner's drive.

- B. Materials: The materials shall consist of sound and durable rock, gravel or stone of the proper gradation meeting ODOT specifications. The material shall be free from cracks, seams, and other defects, which tend to increase deterioration from natural causes. It shall be highly resistant to weathering and disintegration under freezing and thawing and wetting and drying as evidenced by laboratory tests and/or service records. The Division at any time during the project may reject any materials, at the source or job site, not meeting the requirements of these specifications.

Acceptability of material will be determined by laboratory tests, visual inspection and/or service records as required by the Division. Service records will include documentation to show the material has performed satisfactorily on similar structures.

- C. Installation: Upon delivery of the material to the site the Contractor shall install the material in place as shown on the Drawing Plan Set.

- D. Measurement: The material shall be measured for payment by the ton (2,000 pounds) for material acceptably placed in the work as determined by certified scale weight tickets.

All material wasted or used by the Contractor for other purposes and any material not placed in the work in accordance with the requirements of the work order and these

specifications and drawings shall be measured and not included for payment by weight. A conversion factor of 1.5 ton per cubic yard of No. 57 Stone shall be used if necessary.

- E. Payment: Payment for this work as specified above shall be made based on the unit price per ton for "**No. 57 Stone.**"

ROAD MATS (COMPOSITE)

- A. Description: This item shall consist of the transportation, delivery, installation, and removal of road mats as described. The placement of road mats within the limits of construction shall be at the discretion of the Division. This item shall be utilized to protect the existing subgrade, existing utilities, driveways, roadway, curbs, sidewalks, and lawn space that will be traversed within the construction work limits.
- B. Material: Road matting shall be non-permeable, composite mats. Non-permeable, composite mats shall be a minimum of four (4) inches thick with a minimum surface dimension of seven (7) feet wide and thirteen (13) feet long. Non-permeable, composite mats and associated components (i.e. ramps, berms, and fittings) shall be installed per the manufacturer's recommendations.

All materials delivered to the site must be in a shape to be able to cover the area properly and still have the strength and integrity to complete the required work. The Division may reject any mats determined to be damaged beyond useful life or remove square footage as measured from each individual mat.

- C. Execution: Mats shall be kept clean throughout the project. If it is determined by the Division, the mats do not meet this requirement the Contractor shall have any sediment or mud removed immediately.
- D. Measurement: Measurement for payment for the road mats shall be made by actual field measurements of quantities satisfactorily installed at the site. Each road mat shall be measured for a square foot installed.

Road mats shall be utilized for the duration required to plug the well at each site. Only one measurement and payment shall be made for "Road Mats" upon completion of the well site.

- E. Payment: The cost of this work shall be included in the unit price per square foot for "**Road Mats (Composite).**"

SITE SAFETY

- A. Description: The work will include the installation and implementation of safety procedures/requirements for each well site as described herein.
- B. Definitions & Installation: It is the Contractor's responsibility to properly maintain all of

the latter mentioned throughout the duration of the project. Any damages shall be repaired or replaced at no additional cost to the Division. Site safety measures shall be removed prior to the demobilization of the Contractor's workforce.

Any release of materials into or onto the ground or surface waters outside of the primary and/or secondary containment shall follow the Ohio One-Call System as described in Appendix I, "One Call". The Ohio One-Call System shall be contacted at 1-844-OHCALL1 within 30 minutes of becoming aware of the occurrence.

1. Temporary Construction Fence & Posts: The temporary construction fencing shall be composite, orange mesh with a minimum overall height of four (4) feet. Fence posts are to be steel five (5) feet t-posts. Fence materials shall meet the ODOT Construction and Materials Specifications (CMS) Item 710.11.

The posts shall be driven or set in holes to a minimum depth of one (1) foot and at intervals not to exceed ten (10) feet. The fence shall be stretched and securely fastened to each post using metal or plastic ties.

For estimating purposes, fencing shall be placed around the entire work area. The Contractor shall work in conjunction with the Division for placement/layout of the temporary fence. All fence shall be removed at the completion of the project.

2. Air Movers (Industrial Fans): The Contractor will also be required to have onsite industrial fans or air movers **at all times** in the event natural gas is detected and found to be settling at ground level and not properly dissipating from the site (unless otherwise approved in writing from the Division).
3. Temporary Shut-In: The Contractor will shut-in the well each night after the plugging operations have ceased, unless otherwise instructed by the Division. The Contractor will continue this process until the plugging operations are complete and there are no further signs of a gas release.

4. Power/Utility Lines Safety:

Utility lines cross over the access route which will require warning signs to insure awareness.

5. Emergency Response Plan: The Contractor will assemble an Emergency Response Plan (ERP) with all contact information, emergency preventative measures, and for any well-related issues that may occur. ERPs shall be submitted to the Division via email to DOGRM.EMNOTIFY@dnr.ohio.gov for approval prior to beginning work.

The Contractor will be responsible for maintaining this ERP on site during the plugging operations. A copy of the ERP along with the SDS sheets will be stored at the project entrance in a container labeled "ERP/SDS". Ingress/Egress for evacuation and/or public safety will be discussed in the safety meeting to be held on location by the Contractor with local responders and Division personnel. These routes will be listed in

the ERP. The Division will review with the Contractor prior to the start of plugging operations.

- C. Measurement: Measurement for payment will be considered and measured as a unit satisfactorily completed and accepted by the Division.
- D. Payment: Payment for this work, including labor, installation, materials and removal shall be made at the lump sum price for "**Site Safety.**"

SECONDARY CONTAINMENT

- A. Description: This item shall include all labor and materials required for the installation, maintenance, and deconstruction of the secondary containment. Onsite materials and equipment required to be stored within the secondary containment shall be as follows: containers that store liquid brine, oilfield waste, and/or fuels as well as any required pumps. In determining the method, design, and capacity for secondary containment, the Contractor shall address the typical failure mode, and the most likely quantity of brine or other oil field waste substance that would be discharged.
- B. Materials: The Contractor shall supply catchment basins or diversion structures to intercept and contain discharges of brine or other oilfield waste substances during the project. Materials shall consist of impermeable containers or liners made of a material that is compatible with the waste stored or used within the containment. Containment materials shall be impervious and have supporting documentation of the permeability, chemical compatibility, and other applicable QA/QC standards, is acceptable. **Use of a liner shall at a minimum be a 20-mil thickness.**

Materials shall be durable enough to support the weight of heavy equipment used for the plugging operations. Materials shall have sufficient strength and thickness to maintain the integrity of the container or liner. The container or liner shall be designed, constructed, and maintained so that the physical and chemical characteristics of the container or liner are not adversely affected by the waste and the container or liner is resistant to physical, chemical and other failure during transportation, handling, installation and use.

Liner walls shall consist of metal, wood, concrete, plastic, or approved equal. Wall materials shall be designed, constructed, and maintained to withstand the overtopping and sliding forces of secondary containment filled to capacity.

The Division shall determine the merit of the proposed materials compatibility, impermeability, integrity, and durability in determining if the material is sufficient for the project.

- C. Installation: Secondary containment shall be installed prior to any drilling or liquid storage at the project site. **Secondary containment shall extend at least one foot horizontally beyond the primary containment and provide at least one foot in depth capacity or provide a minimum volume equal to 25% of the primary storage capacity.**

Upon request of the Division, the Contractor shall provide calculations in tabular format of the containment providing both the secondary containment capacity and the on-site material storage. The Division can require sections of secondary containment to be removed for inspection and sampling if a spill occurs during the project.

Installation of the containers or liners, including seams and pipe penetrations, shall be in accordance with the manufacturer's recommendations. All seams and non-seam area of the container or liner shall be inspected by the Division for defects, holes, and blisters.

Care shall be taken when operating equipment on or near the container or liner to prevent any damage to the secondary containment. If damage occurs, it shall be repaired by the Contractor at his/her expense prior to continuing the project.

The Contractor shall retain all ownership and responsibility for the secondary containment. All secondary containment shall be removed from the site and retained by the Contractor at the conclusion of the project.

- D. Measurement: Secondary containment, which includes all materials, labor, and equipment necessary to provide the required secondary containment, will be considered and measured as a unit satisfactorily completed and accepted by the Division. Secondary containment shall not be considered complete until all secondary containment has been removed from the site at the completion of the project.
- E. Payment: Payment for this work shall include all material, labor, and equipment necessary to complete the work and be made at the lump sum price for "**Secondary Containment.**"

WELL HEAD CONTROL

- A. Description: This work consists of all labor, equipment, and material necessary to excavate and evaluate existing casing(s) and to establish control of the well. This item shall include the installation of a wellhead control device/flow diverter on the most appropriate well casing as described in the plugging plans.

In the event Division UPC work has been completed on the well, resulting in surface equipment (swages, fittings, valves, gauges, etc.) being installed, the Contractor shall coordinate with the inspector in returning this equipment to the Division for future use. At no point shall the Contractor assume ownership of any surface equipment associated with the well.

- B. Execution: The Contractor is responsible for installing, according to best management practices, a wellhead control device/flow diverter on the well casing. Excavation of the existing casing(s) shall be the responsibility of the Contractor. A four (4) foot minimum excavation/evaluation of the existing casing(s) shall be completed. Casing(s) requiring excavation depths exceeding four (4) feet shall be discussed with the Division prior to starting work. All excavations shall be in accordance with OSHA Construction Standards for excavation and trenching under 29CFR 1926 Subpart P.

The casing shall be free from any damage or defects. If required, the casing shall be cut and cleaned of any dirt, oil, and debris prior to welding extensions and/or installation of the diverter.

The Contractor shall supply a cellar with a cement base around the wellhead. This cellar shall be set around the well and extended up to working elevation, as the depressed area around the well head will be modified to establish workable base. This cellar shall be made of steel, concrete, or polyethylene pipe. **The cellar shall be a minimum of 48 inches in diameter. This work shall include a six (6) inch minimum of Approved Cement as specified or Portland Cement in the cellar base with a three (3) inch minimum port near the well. The port shall extend up to within three (3) inches of the well at working height and be used to monitor and contain any gas/oil escaping around the back side of the casing.**

Once a well head control device is installed, all fluids, gases and solids generated by the plugging process shall be diverted into a tank. This tank shall be set a minimum of twenty (20) feet from the well. The Contractor shall also maintain an adequate supply of well kill fluid at the well for possible well control emergencies, which shall be paid under the line item "**Well Kill Fluid.**" The injection point for the kill line will be a minimum of twenty (20) feet from the well.

For the duration of this project the following wellhead control will be utilized. The wellhead control device/flow diverter assembly will have two 4.5-inch diameter discharge ports. The diverter lines running from both 4.5-inch diameter discharge ports on the wellhead assembly to the above ground steel tank will consist of two (2) – 4.5-inch diameter steel lines. Both diverter lines will have two inline valves (rated minimum 1,000 psi) for control of flow. Lines will discharge into the tank at a downward angle or at an angle that will reduce fluids from splashing or spraying out of the tank if a sustained blow is encountered while drilling out the plugged wells. These lines will be a fixed connection

(i.e. hammer union, flanges) to the steel pit with equipment that is capable of withstanding the possible pressures encountered. One of the 4.5-inch diverter lines will be equipped with a 2-inch diameter port and valve that will serve as the kill line access. This port and valve will be installed between the wellhead and the 4.5-inch inline valve.

No well operations shall begin until an inspection of the prepared well has been completed by the Division.

- C. Measurement: Measurement for payment shall be made by field inspection of units satisfactorily completed and accepted by the Division.
- D. Payment: Payment for the above-described work, which includes all labor, materials, equipment necessary for the well head control shall be made at the cost proposal lump sum price for "**Well Head Control.**"

WELL KILL FLUID

- A. Description: The work covered by this section shall consist of furnishing all labor, equipment, and material necessary to provide and use weighted brine as a "kill" fluid for the drilling and plugging process of the well.
- B. Requirements: The Contractor shall provide a weighted brine of sufficient density to kill the well and regain well control in the event of a sustained and/or uncontrolled wellbore kick (a rapid influx of formation fluids and/or gases into the wellbore).

Sufficient density shall be defined as dense enough to exert hydrostatic pressure greater than the anticipated formation pressure but less than the anticipated formation fracture gradient.

The Division will require a minimum of 100 barrels of 9.0 pound-per-gallon weighted brine kill fluid be maintained at each well site throughout the plugging project for the sole purpose of killing the well to regain well control when required.

A mud pump of sufficient size/capacity shall be required to be onsite at all times during plugging operations as means to pump well kill fluid when required.

- C. Measurement: Measurement for payment for the above-described work shall be made by the actual quantity of barrels (bbls) of weighted brine used as a kill fluid for the orphan well as approved by the Division. The Division will at a minimum pay for the quantity required to be maintained on site.
- D. Payment: Payment for the above work shall be made at the unit price per barrel (bbls) for "**Well Kill Fluid.**"

WELL PREPARATION & PLUGGING

- A. Description: This work consists of all labor, equipment, and material necessary to prepare the well for plugging and completing all required plugs. This shall include cleanout,

drillout, and washover of the well bore to the total depth of the well based on the well description(s) and plugging plan(s), circulating the well bore prior to each plug, setting all required plugs, and verification of each plug depth.

- B. Execution: The Contractor shall supply all equipment needed to complete the well preparation in an efficient manner that will be approved by the Division. This shall include but not be limited to the rig, drill pipe, collars, mud pump (See General Specifications, Part 13 for minimum requirements), circulating fluid, cementing equipment, mix water, and associated equipment.

Cable tool/spudding rigs shall not be permitted for use unless otherwise authorized by the Division as described under the General Conditions, Part 13 "Substitution During the Project".

Once well head control has been established, the Contractor will cleanout, drillout and/or washover and then circulate the well bore prior to setting any casing or well plugs. The Contractor shall be responsible for having a minimum of two (2) hole volumes of fluid available for circulation.

The Contractor shall identify the diameter of the well bore below the surface casing and cleanout or drillout with a full-size bit to total depth. **In addition to the full-sized bit, the Contractor shall also supply a bore brush and/or casing scraper at the appropriate size to fully clean out any casing remaining per the plugging plan.** In any case where an obstruction is encountered and total depth cannot be achieved, the Contractor shall immediately notify the Division. The Contractor shall propose a plan to assess the nature of the obstruction that shall be approved by the Division. Additional work associated with removal of the obstruction shall be described and paid for under the Contingency Specifications and as listed on the Quantity Sheet and agreed upon by the Division.

The Contractor shall trip out or up into the nearest competent cased string and secure all tools at the end of each workday or when work shall be paused for an extended time. Any tools left in the hole during such paused work shall be at the Contractor's own risk. Any tools or tubing that are lost due to the Contractor's failure to complete the task of tripping out during paused work times shall be at their own expense as well as any work required to then prepare the hole to continue the plugging process (this shall include but not be limited to shooting, fishing, over drilling, lost or damaged tools, etc.). The tripping out of the tools during paused work times shall be incidental to this line item.

Formations within the well bore known to be producing H₂S gas will not be circulated prior to setting a plug.

Prior to setting any plugs the Contractor shall remove all free crude oil by **circulating the wellbore two-hole volumes or until the well is static; a minimum of ten (10) barrels of gel is required to be run ahead of each cement plug that may come into contact with open hole formation at the discretion of the Division.** A minimum of four (4) sacks of bentonite gel per ten (10) barrels of freshwater shall be required if requested. This work shall be considered incidental to this line item. No additional payment shall be made for circumstances where the Contractor does not have the appropriate material on location.

Lost Circulation Material (LCM) may be used to aid in obtaining circulation, as approved by the Division. **Lost Circulation Material (LCM) shall NOT be used when tubing smaller than 1.5 inch inside diameter will be utilized. Circulation must be established prior to conducting cementing procedures.** LCM shall be available at the site during the completion of this line item "**Well Preparation & Plugging.**" The Contractor shall provide up to five (5) sacks of LCM per well for use (e.g. cotton seed hulls, bentonite gel/polymer, cellophane flake) incidental to this line item). Additional need for use of LCM shall be per the "**Lost Circulation Material**" specification included in the Contingency Specification.

The well shall be in a static condition prior to beginning any cementing activities.

The Contractor shall set all plugs as described in the **Plugging Plan** to the depths described with the materials described. This shall include setting the bottom plug, intermediate plugs, and the surface plug. All plugs shall be allowed to set for the periods described in the **Plugging Plan**.

The Contractor shall be required to tag all cement tops unless otherwise approved by the Division. Tagging with a sinker bar and depth meter is recommended. Confirmation of cement tops shall be considered incidental to this line item.

If a plug has dropped or is determined to not be a competent plug, then drill out of the plug or additional staged plugs may be required at the discretion of the Division as a part of this line item. The Division reserves the right to adjust the Plugging Plan during the plugging process based on site conditions.

- C. Measurement: Measurement for payment shall be made by field inspection of units satisfactorily completed and accepted by the Division.
- D. Payment: Payment for the above-described work, which includes all labor, materials, and equipment necessary for the well preparation and plugging, shall be made at the lump sum price for "**Well Preparation & Plugging.**"

LOGGING

- A. Description: This work consists of all labor, equipment, and material necessary to determine the total depth of the well and the casing, if a packer is present (along with its depth and thickness), determine bond quality behind the casing and the free point of the casing. The Log should also confirm zones of gas production and formation tops for cementing purposes. All cement plug depth and thicknesses will be based on log data of the first well plugged on the site.

Logs shall ONLY be ran at the discretion of the Division based on the conditions encountered regardless of the direction given in the Plugging Plan.

- B. Execution: The Contractor shall complete the logging of the well bore, casing, tubing,

packer, and/or cement to the depth of the existing well bore, casing, tubing, packer, and/or cement. The methods of logging to be used shall be as indicated on the individual plugging plan and may include but not be limited to **gamma ray (GR), casing collar locator (CCL), temperature, bond, and caliper log**. Prior to use, the Contractor shall propose the method of logging and shall be approved by the Division.

- C. Measurement: Measurement for payment shall be made by field inspection of units satisfactorily completed and accepted by the Division. **A copy of the log shall be provided with the invoice as backup documentation.**
- D. Payment: Payment for the above-described work, which includes all labor, materials, equipment necessary for the investigation of the well shall be included at the per unit price per each for "**Logging.**"

MILLING/DRILLOUT

- A. Description: This work consists of all labor, equipment, and material necessary to remove an obstruction from inside the wellbore or casing as needed to reach a required depth by means of milling/drilling.

This work may include removing metal, cement, grout, wood plugs, failed cement plugs and/or other materials in which typical cleanout operations failed to remove.

- B. Execution: The Contractor shall supply the equipment needed to complete the work in an efficient manner that will be approved by the Division. This shall include but not be limited to the rig, a mud pump, power swivel/power sub, drill string (including collars and casing or tubing) and associated equipment.

This shall not include the bits required to complete this work. The Division will develop a negotiated change order to deliver and use the appropriate bit(s) required based on the unforeseen conditions. Bit types shall be based on the type of material encountered. Bits shall be factory made unless otherwise approved in writing by the Division.

- C. Measurement: Measurement for payment shall be made by field inspection of the actual quantity of hours in which the drilling rig and equipment were diligently operating in a manner to remove the obstruction.
- D. Payment: Payment for the above-described work, which includes all labor, materials, equipment necessary for the obstruction removal shall be made at the unit price per hour for "**Milling/Drillout**".

TUBING

- A. Description: This item covers all labor, equipment, and material required to supply tubing at the site for the purposes of placement of cement and spacers.

- B. Materials: The Contractor shall supply a 1.5-inch inside diameter (ID) or larger tubing in a condition that will allow for the pumping of cement for the purposes of plugging the well. A mud anchor and/or perforations on the bottom joint of the tubing is recommended. Any issues caused due to running tubing open ended shall be the Contractor's responsibility.

For this project the Contractor shall supply up to 1,710 feet of 1.5-inch ID or larger tubing to all the project wells.

- C. Installation: The Contractor will install and remove the tubing as necessary in order to complete the **Plugging Plan**. The Contractor shall maintain ownership at the conclusion of the project of all tubing that was brought to the site for these purposes.
- D. Measurement: Measurement for payment of the above-described work shall be made by actual field measurements per linear foot of tubing delivered to the site.

Tubing shall be measured as one use for the duration of the project.

- E. Payment: Payment for this item shall be made at the lump sum price for "**Tubing.**"

APPROVED CEMENT

- A. Description: This item shall cover all labor, materials, and equipment necessary to plug the well as specified in the **Plugging Plan**.
- B. Materials: Cement materials shall be approved prior to placement. The cement must conform to the following options:
- a. API Class "A"
 - b. API Class "L"
 - c. ASTM C150 Type 1
 - d. ASTM C595 Type 1L

(Note: These are the only material options that will be approved, any other materials may be submitted to the Division for review but will **not** be approved for this project)

The cement shall contain 2% Calcium Chloride, properly blended, **only if directed** by the Division in advance of placing the cement. **Coordinate with the Division prior to ordering cement.**

The cement shall not contain bentonite or extenders which delay set time or decrease the overall compressive strength unless otherwise noted.

Additives (e.g. cotton seed hulls, cellophane flake, etc.) used for the purposes of lost circulation zones shall be considered incidental to this line item.

Water used for cementing shall be free of any impurities that will adversely affect set time and compressive strength.

- C. **Installation:** The Contractor shall notify the Division at least 24 hours in advance of placing the cement, including notification of the type of cement being used for approval.

Additional wait times may be required for the type of cement used. This wait time shall be incidental to this line item. Upon approval of the type of cement the Division shall inform the Contractor of the required wait times for each staged plug.

Preparation of the well bore, including the running of gel flush ahead, shall be completed per line item **“Well Preparation & Plugging”** prior to placement of the cement.

The cement slurry shall be mixed at the API recommendation, between 15.4 and 15.8 pounds per gallon.

The Cement shall be placed to the depths and intervals described in **Plugging Plan**.

It is the Contractor’s responsibility to provide a mud scale for weighing the cement slurry.

When using API Class “L” cement or ASTM C595 Type 1L cement, all the following conditions apply:

- Mill test information must be provided to the applicable Division inspector prior to utilization of API Class L cement or ASTM C595 Type 1L cement. The mill test information must be a representative sample of the mixture of cement proposed to be used to plug the well. A person is not required to provide the mill test information if the Division already has the mill test information of the mixture of cement for a batch.
- Performance data shall be provided in compliance with Ohio Administrative Code 1501:9-11-07 prior to usage. To determine if Ohio Administrative Code 1501:9-11-07 is met, test results shall include at a minimum slurry density, composition, compressive strength, free fluids, thickening time, curing pressure, and curing temperature. The data also shall include percent limestone and percent pozzolan material.
- For blended cement containing limestone and pozzolanic material, the combination of the materials shall not exceed fifty per cent by volume.
- A sample of at least 20lbs representative of the of cement mixture proposed to be used in a well must be provided to the Division at the request of the Division.
- A person using API Class L cement or ASTM C595 Type 1L cement shall leave the plugged well in a manner that will allow for further inspection past the contract requirement of three days after the completion of the uppermost plug unless the applicable Division inspector determines that the contract requirement of three days is sufficient.

- D. **Setting:** Setting times shall be completed as described in the **Plugging Plan**. For the surface

plug any void space between the top of the cement and the top of the casing shall be filled to achieve a level cement line with the top of the casing. This shall be done at no additional cost to the Division.

The cement must develop a minimum compressive strength of 500 PSI after 24 hours at well bore temperatures. The Division reserves the right to collect test cylinders throughout the duration of the cementing process.

- E. Measurement: Measurement for payment shall be based on the actual quantity of sacks of cement acceptably placed and shall be verified with delivery tickets. A sack shall be considered 94 pounds prior to mixing.
- F. Payment: The above-described work shall be paid for at the unit price per sack for "**Approved Cement.**"

SURFACE CASING (7")

- A. Description: This item covers all labor, equipment, and material required to set the surface casing for the plugging of the orphan well.
- B. Materials: The surface casing shall be a 7-inch diameter casing conforming to a 17-20 pound per foot STC (Short Thread and Coupling) or an approved equal material specifications. The Contractor shall supply the proper ranges and pup joints to complete the lengths required during installation.

Pipe shall be new pipe or used pipe that has been tested and drifted. The Contractor shall supply documentation for pipe that has been tested and drifted. The Division shall approve used pipe based on documentation and inspection of the pipe.

The casing will be equipped with a float shoe on the bottom joint. This shall be incidental to this line item.

- C. Installation and Execution: The surface casing shall set to a depth as detailed in the **Plugging Plan and Quantity Sheet**. This quantity is for estimating purposes only. Prior to setting any surface casing, the Contractor shall review the plan with the Division. No surface casing shall be set without Division approval.

Drilling shall be completed with an appropriately sized drilling bit. All surface casing shall be drilled with freshwater and set in place. The Division shall not be responsible for additional materials if an alternative method or drill bit is proposed for use.

Centralizers shall be used when setting surface casing. At minimum, both the bottom and top joint of the surface casing shall be equipped with centralizers. The Division reserves the right to adjust centralizer locations and quantities as needed.

In the event that there is not a competent bottom to pump cement, the Contractor shall be required to provide and install a cement basket at the discretion of the Division. This shall be

considered incidental to this line item.

- D. Measurement: Measurement for payment for the surface casing work shall be made by actual field measurements of quantities satisfactorily installed and completed per linear foot of surface casing set.
- E. Payment: Payment for this item shall be made at the unit price per linear foot of "**Surface Casing (7")**".

CEMENT MIXING & PUMPING

- A. Description: This item shall cover all labor, materials, and equipment necessary to mix and pump cement as specified in the **Plugging Plan**.
- B. Execution: Cementing equipment required on site to mix and pump casing cement and cement plugs shall be provided until each individual casing cementing or plug cementing is completed. This shall include but not be limited to pump truck, mud pump, and associated equipment.
- C. Measurement: Measurement for payment shall be for each trip to the project site in order to complete the plug(s) as described in the **Plugging Plan**. Payment for staged plugs shall be measured as one unit.
- D. Payment: Payment for the above-described work, which includes all labor, materials, equipment necessary for the mixing & pumping of cement into the well shall be made at the unit price per each for "**Cement Mixing & Pumping**."

SITE RESTORATION

- A. Description: This work shall cover all operations incidental to the establishment of grasses within the areas disturbed by the Contractor, including the furnishing and sowing of seed; and furnishing and applying of mulch materials, all in accordance with these specifications. Additionally, this work shall include, but not be limited to, repair of grounds and vegetation, including landscaping amenities, ornamental shrubs and trees damaged in any manner during the work operations. All areas shall be properly graded to a smooth final grade with topsoil and blended into adjoining areas at the most moderate slope possible. Seedbed preparation through the use of scarifying equipment is also required. All site restoration work is to be completed within **fourteen (14) days** of the completion of the construction activities. The Contractor may request in writing to the Division an extension for site restoration. Requests shall only be granted based on season or weather conditions.
- B. Materials: The materials to be used for restoration shall conform to the applicable requirements of these specifications.
 - 1. Lime: Pelletized lime shall be applied at a maximum rate of 400 pounds per acre. Rates may be adjusted by the Division at the time of application.

2. Fertilizer: Fertilizer shall be commercial grade (19-19-19) and shall be applied at a rate up to a maximum of 20-lbs/1000 sq. ft. Rates may be adjusted by the Division at the time of application.
3. Seed: The varieties of grass seed to be furnished to the project shall bear a tag on each bag of each species showing the lot number, grower's name, percent of purity, percent of germination, and weed content. Tags shall be provided to the Division.

All seeds shall be free from noxious weeds and under no condition shall the total weed content of any lot of seed or seed mixture exceed one-half of one percent by weight.

No seed shall be utilized which has a mix date older than one year. The Division reserves the right to test, reject, or approve all seed after delivery to the project.

Species Composition:

Yard seed shall be applied at a rate of 10 lbs/1000 sq. ft. and shall conform to the following seed mixture ratio:

98/85 Kentucky Bluegrass	50%
Perennial Ryegrass	50%

All areas not designated as yard, farm field, or wetland shall use the following seed mix, and shall be sown at the indicated rate. This mixture is listed by recommended planting season and for existing site conditions, and/or intended use. Further information may be found in the Agronomy Guide, Bulletin 472, Cooperative Extension Service, The Ohio State University.

<u>GENERAL SEED MIX</u>	<u>lbs/acre</u>
Orchardgrass (<i>Dactylis glomerata</i>)	15.0
98/85 Kentucky Bluegrass	12.0
Timothy (<i>Phleum pratense</i>)	12.0
Birdsfoot Trefoil (<i>Lotus sp.</i>)	9.0
Red Clover (<i>Trifolium pratense</i>)	8.0
White Clover (<i>Trifolium repens</i>)	7.0
Annual Ryegrass (<i>Lolium multiflorum</i>)	8.5
<u>Perennial Ryegrass (<i>Lolium perenne</i>)</u>	<u>3.5</u>
Total lbs/acre	75

Other types of seed may be substituted if requested by the property owner(s). If such substitutions are made, they are to be made at no additional cost to the Division.

4. Mulching Material: All mulch material shall be free from mature seed-bearing stalks or roots or prohibited or noxious weeds. Any type of hay is not acceptable. Mulch shall include baled wheat straw or oat straw. It shall be dry and reasonably free of weeds, stalks, or other foreign material.

For all required materials listed above, the Division reserves the right to request receipts, material specifications and/or weight tickets for verification.

C. Installation:

1. Start of Work: Site restoration work shall begin as soon as possible after the completion of construction. Final site restoration operations shall be completed within fourteen (14) working days of the final construction activities. The Contractor may request in writing to the Division an extension for site restoration. Requests shall only be granted based on **season or weather conditions**.
2. Area Preparation of Soil: Spread and grade available topsoil uniformly over all disturbed areas. All areas to be seeded shall be loosened by discing, harrowing, or other approved methods immediately prior to seeding. The soil shall be loosened to a depth of approximately three inches.

Hand raking shall be required in all areas where machines do not obtain the results desired by the Division.

Following tilling of the soil, the seedbed shall be allowed to firm up.

All final prepared surface(s) shall have a smooth final grade and be appropriate for a residential yard, free from rocks, large dirt clumps and any other foreign debris.

Immediately following area preparation for seeding, materials shall be applied in the following order:

- Lime, as applicable
- Fertilizer, as applicable
- Seed, after broadcasting or otherwise applying the seed, the surface of the seedbed shall be loosely disturbed by hand raking, dragging, and/or cultipacking.

Lime, fertilizer and/or seed shall be sown by approved methods that provide for uniform distribution of the mixes as specified above.

3. Mulching: Apply the equivalent of 100 pounds per 1,000 square feet of clean straw mulch.

Apply mulch to the sown area within 24 hours of seeding at the rate per square feet as specified above and spread to a uniform depth.

The straw shall be placed in a moist condition or shall be moistened immediately after placement.

4. Maintenance and Repairs: The Contractor shall, during construction and prior to acceptance, properly care for all areas mulched and perform all mulching operations necessary to provide protection and establish growth of the seeded areas. Mulch that

becomes displaced shall be reapplied at once, together with any necessary reseeded, all at no expense to the Division.

No additional payment shall be made for acts of God, i.e. fire, flood, drought, etc.

D. Maintenance Period: The permanent planting of trees, shrubs, perennials, annuals, grasses and legumes, etc. shall be deemed to be acceptable if the species that were planted in accordance with the approved plans are established and maintained for one (1) "growing season" as defined below and meeting the following standards:

1. Growing Season: All landscaping shall be guaranteed for a period of one (1) summer growing season after planting. Planting material installed in the Fall shall be in full count and thrifty condition on the next succeeding September 15 at which time replacement shall be determined and scheduled for installation during the planting period of October 15 - December 1 of that same season. Planting material installed in the Spring shall be in full count and thrifty condition on the next succeeding May 15 at which time replacements shall be determined and scheduled for installation prior to June 1 of the same season. All plants installed in the summer shall be guaranteed for one (1) full summer and shall be in full count and thrifty condition the next succeeding September 15.
2. Acceptable Lawn/Turf Areas: A series of four (4) random line transects are to be laid out within the project boundaries. A string one hundred (100) feet long having one (1) foot graduation, shall be placed along the transect line. The person conducting the transect will then walk along the line counting only the markers which are in actual contact with the vegetation. The number of count points are to be recorded as subtotals. When the four transects are completed, the average of the four transects subtotals is then equal to the percent of vegetative cover for the project.
 - a) Residential Lawns: At least one hundred percent (100%) of the land affected shall be judged to be of good quality, and "good" is defined as an area that has at least ninety percent (90%) cover.
 - i. All land affected and having less than ninety percent (90%) cover shall be judged poor and deemed unacceptable; and
 - ii. All areas judged to be good must have species diversity requirements of those recommended for planting.
 - b) Farm & Field Turf: At least ninety percent (90%) of the land affected shall be judged to be of good quality, and "good" is defined as an area that has at least seventy-five percent (75%) cover.
 - i. The remaining ten percent (10%) of the land affected shall be judged to be of fair quality, and "fair" is defined as an area that has at least fifty percent (50%) cover but less than seventy-five percent (75%) cover;
 - ii. All land affected and having less than fifty percent (50%) cover shall be

judged poor and deemed unacceptable; and

iii. All areas judged to be good or fair must have species diversity requirements of those recommended for planting.

c) Severe Decline of a Tree or Shrub: Shall be defined as the death of a major leader or 50 percent of the crown of a tree or shrub or dieback of a plant to the ground, even if that plant is still alive.

E. Measurement: Measurement for payment of site restoration, which includes seedbed preparation, lime, fertilizer as applicable, seeding, mulching, and replacement of landscape amenities (i.e. shrubs, trees, etc.) shall be considered and measured as a unit satisfactorily completed and accepted by the Division.

F. Payment: Payment for this work, which includes seedbed preparation, liming, fertilizing, seeding, mulching, required replacement of all shrubs, trees and landscaping amenities, etc., and general cleanup shall be made at the lump sum price for "**Site Restoration.**"

APPROVED RESOIL

A. Description: This work shall consist of furnishing all labor, material, and equipment necessary for the hauling, spreading, and grading of the resoil material for the replacement of the removed contaminated soils. This work shall also include shaping for positive drainage and matching the surrounding contours.

B. Material: Material shall be a good quality resoil and **not** include rocks, stones, and objectionable material over three (3) inches in any one dimension. All resoil that will compose the top eighteen (18) inches of resoil at the ground surface shall be topsoil. Topsoil shall be defined as during excavation having a brown matrix color, less than 50% clay content, and enough organic materials to be generally suitable for vegetative growth.

C. Installation: Care shall be taken to keep heavy equipment off the surface material after it has been spread. If the resoiling material becomes compacted, the Contractor shall disc the material to a depth of four (4) inches at the Contractor's expense.

D. Measurement: The material shall be measured for payment by the ton (2,000 pounds) for material acceptably placed in the work as determined by certified scale weight tickets.

All material wasted or used by the Contractor for other purposes and any material not placed in the work in accordance with the requirements of the work order and these specifications and drawings shall be measured and not included for payment by weight. A conversion factor of 1.3 tons per cubic yard of resoil shall be used if necessary.

E. Payment: Payment for this work shall be made at the unit price per ton for "**Approved Resoil.**"

CONTAMINATED MATERIAL DISPOSAL

A. Description: This item shall consist of removing contaminated soil and cuttings from the site for off-site disposal. Soil and cuttings to be removed shall be at the discretion of the Division and shall be disposed of at an approved EPA licensed landfill as provided by the Contractor prior to removal from the site.

B. Material:

Contaminated Soils/Cuttings/Drill Fluids: Contaminated soils, cuttings and drill fluids are defined as soils, cuttings and materials in which oil, gas, condensate, brine, plugging products, or oil field waste substances have been released in or on the land and/or materials generated by the Contractor while working on the well.

Contaminated Soils: The Contractor will excavate and properly dispose of all soils from the location that are visibly impacted with oilfield contaminants. Areas to be excavated shall be at the discretion of the Division and/or as shown on the Drawing Plan Set.

Contaminated soils shall be loaded and hauled away as they are excavated.

Cuttings/Drill Fluids: Cuttings and drill fluids generated as part of the plugging process shall be temporarily stored onsite. The Division reserves the right to require removal of these materials at any time. The Contractor shall be aware at all times of capacity limitations. Should removal of materials be required, the Contractor shall be responsible for properly cleaning onsite tanks. Any downtime associated with the removal shall be done so at no additional expense to the Division.

The Contractor shall solidify any residual fluid associated with these materials with Portland Cement or by other means approved by the Division, prior to removal as a part of this line item. Prior to solidification of contaminated materials, the Contractor shall use due diligence to remove fluids from the contaminated materials. Fluids removed from the contaminated materials shall be disposed of per line item "**Fluid Disposal.**"

Soils/material deemed "contaminated" as a result of Contractor negligence during the plugging process will be removed and disposed of at the Contractor's expense. Disposal procedures will conform to all requirements stated within this line item.

C. Off-Site Disposal: Material designated as "contaminated" shall be hauled to an appropriate licensed landfill. Copies of truck weight tickets from the landfills shall be furnished within 3 days of acceptance to the Division.

No additional compensation shall be made for onsite contaminated material storage. If materials remain onsite, proper containment shall be established meeting all requirements as described in line item "**Secondary Containment**" at no additional cost to the Division. Onsite storage time shall not exceed 72 hours after plugging activities have been completed.

D. Measurement: Measurement for payment shall be verified based on quantities disposed of

at the approved EPA licensed landfill. Documentation required shall include driver's haul tickets, certified scale tickets and a copy of the paid invoice from the landfill/waste facility (dollar amounts may be redacted from the invoice copy).

- E. Payment: Payment shall be made at the unit price per ton for "**Contaminated Material Disposal.**"

SALVAGE MATERIAL DISPOSAL

- A. Description: This item shall consist of preparing, removing, and salvaging all materials from the site that have a salvage value as shown on the Drawing Plan Set or as required by the Division. All items to be salvaged shall include all surface equipment, well casing, and production equipment. Salvage items shall also include any hydrocarbon materials (oil, condensate, etc.) that have a marketable value. Salvage items shall be stored onsite within the construction project limits until removed for salvage.
- B. Off-Site Disposal: Prior to removal from the site the Contractor shall supply in writing to the Division an inventory of all materials to be salvaged. On behalf of the Division, the Contractor shall salvage materials inventoried. Once materials have been salvaged the Contractor shall reimburse the Division for the salvage value per line item "**Salvage Material Reimbursement.**"

At the request of the Division, surface equipment deemed as reusable shall be forfeited directly to the Division's onsite representative. This shall include but not be limited to swages, wellheads, fittings, appurtenances, etc. At no time shall salvageable material become property of the Contractor.

Prior to disposal of any salvage materials from the project site, **the Division will complete a radiological assessment** of salvage materials that have been provided on an inventory to the Division.

The Division shall be given a minimum of two (2) working days notice to complete the assessment. Salvage materials staged on the project site shall be staged on a pipe rack where determined applicable by the Division. Salvage materials shall be on an impervious liner that will collect any residual fluids or scale.

Any materials which exceed 50 micro- Roentgen per hour ($\mu\text{R/hr}$) or deemed by Division staff to be radioactive shall not be considered for "Salvage Material Disposal"; instead this material shall be considered "Radioactive Material Disposal" and be disposed of per ton at a negotiated change order rate agreed upon by the Division or at a rate originally agreed upon on the Offer Sheet.

Prior to disposal of any salvage materials the Contractor shall prepare, including cleaning, the salvage materials for lawful salvage.

All salvageable material shall be cleaned onsite. The final product shall be non-hazardous and, in a condition, to not cause offsite pollution/contamination during transport and/or

disposal. Any downtime associated with proper decommissioning shall be considered incidental to this line item.

- C. Execution: The Contractor shall include in this line item any expense incurred with the removal and the salvaging.
- D. Measurement: Measurement for payment shall be made by field inspection of units satisfactorily completed and accepted by the Division.
- E. Payment: Payment shall be made at the lump sum price for "**Salvage Material Disposal**."

FLUID DISPOSAL

- A. Description: This item shall consist of removing and disposing of the fluid generated from the well plugging process. Fluids to be removed shall be at the discretion of the Division and shall be injected at an approved Class II disposal well as provided by the Contractor prior to removal from the site.
- B. Material: Materials will be defined below as described for the purposes of this scope of work.

Contaminated Fluids: Contaminated fluid will be considered as all fluids used in the circulation of the well bore, fluids utilized as a "kill" substance and/or fluids generated from the well. The Division reserves the right to deem a fluid "contaminated" at its discretion.

Contaminated fluids are further defined as water that contains quantifiable concentrations of oil, natural gas(es), condensate, brine, plugging products, or other oil field waste substances.

Freshwater: Water that has not been classified as contaminated fluid and has been stored in an uncontaminated container shall be visually inspected for oil sheen, and field tested for pH and chlorides. The chloride concentration shall be less than 250 mg/L and the pH shall be within a range of 6.5-8.5 standard units (SU). If water is deemed as freshwater based on these inspections and tests, the Contractor may discharge freshwater into or onto the land in an appropriate manner. Freshwater disposal shall not be paid for under this line item "**Fluid Disposal**."

- C. Off-Site Disposal: Fluids designated as "contaminated" shall be hauled to an appropriate Class II disposal well. Proof of disposal from the disposal well shall be furnished within three (3) days of acceptance to the Division.

No additional compensation shall be made for onsite fluid storage. If contaminated fluids remain onsite, proper containment shall be established meeting all requirements as described in line item "**Secondary Containment**" at no additional cost to the Division. Onsite storage time shall not exceed 72 hours after plugging activities have been completed.

- D. Measurement: Measurement for payment shall be verified based on documentation proof

of a quantity of disposal from the disposal well utilized. Documentation required shall include driver's haul tickets, fluid disposal tickets and a copy of the invoice paid from the Class II disposal well (dollar amounts may be redacted from the invoice copy).

- E. Payment: Payment shall be made at the unit price per barrel for "**Fluid Disposal.**"

DEBRIS REMOVAL & DISPOSAL

- A. Description: This item shall consist of removing debris and trash from the site for off-site disposal. Items to be removed shall be at the discretion of the Division and shall be disposed of at an approved EPA licensed landfill.
- B. Off-Site Disposal: Debris and trash shall be hauled to an appropriate licensed landfill. Copies of truck weight tickets from the landfills shall be furnished daily to the Division.
- C. Salvage: Items or materials on the project site the property owner wishes salvaged shall be set aside in an orderly manner. Salvaged items shall not be placed in an area that prevents adequate completion of the project according to the Drawing Plan Set. Salvage items do not include material and/or equipment associated with the well.
- D. Measurement: Measurement for payment shall be verified based on weight tickets of quantities disposed of at the approved EPA licensed landfill.
- E. Payment: Payment shall be made at the unit price per ton for "**Debris Removal and Disposal**".

DETAILED SPECIFICATIONS FIXED PRICE ITEMS (Values set by the Division.)

SALVAGE MATERIAL REIMBURSEMENT

- A. Description: This item shall consist of reimbursing the Division for all materials removed from the site for salvage including all surface equipment, well casing, tubing, production equipment, and marketable hydrocarbons.
- B. Reimbursement: The Contractor shall supply salvage receipts to the Division for materials inventoried and removed from the site for salvage. The Division shall use these receipts as deduction of payment that will be represented on the Offer for this line item for this project.
- C. Measurement: Measurement shall be made by salvage receipts amounts.
- D. Payment: Deduction shall be entered as an amount for "**Salvage Material Reimbursement.**"

CONTINGENCY SPECIFICATIONS

CONTINGENCY SPECIFICATIONS WILL ONLY BE DIRECTED VIA A FIELD ORDER FROM THE DIVISION. THE FIELD ORDER WILL DEFINE THE QUANTITY APPROVED. CONTINGENCY SPECIFICATION USE WILL BE DETERMINED BASED ON-SITE CONDITIONS THAT ARE DETERMINED BY THE DIVISION.

ADDITIONAL CIRCULATION FLUID

- A. Description: This work shall consist of furnishing all labor, equipment, and material necessary to provide additional circulation fluid for the drilling and plugging process for the well.
- B. Requirements: The Contractor shall receive prior approval from the Division before bringing additional circulation fluid onsite. The fluid type shall be as listed below and based on the requirements of the original plugging plan.

Freshwater: Freshwater brought to location shall be free of oil sheen, and field tested for pH and chlorides. The chloride concentration shall be less than 250 mg/L and the pH shall be within a range of 6.5-8.5 standard units (SU).

Brine: A mixture composed of water and dissolved salts at a required density defined in the Plugging plan. Prior to supplying additional brine to location for use as a circulation fluid, the Contractor shall confirm the required density.

Fluid type, characteristics and quantities shall be confirmed with the Division prior to bringing onsite.

- C. Measurement: Measurement for payment for the above-described work shall be made by the actual quantity of barrels (bbls) used to successfully plug and/or drill the orphan as approved by the Division.
- D. Payment: Payment for the above work shall be made at the unit price per barrel (bbls) for **“Additional Circulation Fluid (Freshwater)”**

PERFORATING

- A. Description: This work consists of all labor, equipment, and material necessary to perforate a casing or tubing at a determined depth for the purpose of squeezing cement outside the casing or tubing string.

- B. Execution: The Contractor shall complete the perforating of the casing or tubing at a depth approved by the Division. This work shall include logging the well with a standard logging suite at the discretion of the Division to identify perforation interval(s).

The Contractor shall propose the material and method for perforating the casing or tubing and shall be approved by the Division. **Each unit for perforating shall include two (2) shots with ten (10) perforations per shot, for a total of 20 perforations.**

- C. Measurement: Measurement for payment shall be made by field inspection of units satisfactorily completed and accepted by the Division. **A copy of the log shall be provided with the invoice as backup documentation.**
- D. Payment: Payment for the above-described work, which includes all labor, materials, and equipment necessary for the perforating the casing or tubing made at the unit price per each for "**Perforating.**"

DOWNHOLE VIDEOGRAPHY

- A. Description: This work consists of all labor, equipment, and material necessary to video record the well bore to assess the well bore obstruction.
- B. Execution: The Contractor shall supply all equipment needed and complete the videography recording of the well bore to the depth of the current obstruction. The Contractor shall supply the Division with an electronic copy of the videography recorded in a format viewable in readily available current software.

The Division is not obligated to provide camera services to the Contractor. At no point shall the Division be responsible for delays associated with availability of camera runs.

- C. Measurement: Measurement for payment shall be made by the delivery of an acceptable video and photos to the Division of the current obstruction. Measurement shall be per obstruction, not per video or photo.
- D. Payment: Payment for the above-described work, which includes all labor, materials, equipment necessary for the video recording of the current obstruction made at the per unit price per each for "**Downhole Videography**".

FISHING

- A. Description: This work consists of all labor, equipment, and material necessary to remove and/or clear the well bore as needed to reach total depth by the means of fishing the obstruction in the well bore.
- B. Execution: The Contractor shall supply the equipment needed to complete the fishing in an efficient manner that will be approved by the Division. This shall include but not be limited to the rig, impression blocks, and associated equipment. **This shall not include the fishing**

tools required to complete this work. The Division will develop a negotiated change order to deliver and use the appropriate fishing tools required based on the unforeseen conditions. Appropriate fishing tools shall be provided for the circumstances encountered.

- C. Measurement: Measurement for payment shall be made by field inspection of the actual quantity of hours in which the drilling rig and other fishing equipment were diligently operating in a manner to remove the obstruction.
- D. Payment: Payment for the above-described work, which includes all labor, materials, and equipment necessary for the obstruction removal, shall be made at the unit price per hour for "**Fishing**".

MAGNET

- A. Description: This work consists of all labor, equipment, and material necessary to supply a magnet and the required subs as the fishing tool.
- B. Execution: The Contractor shall supply all equipment needed for a magnet fishing tool to be used for fishing out the well bore to the depth of the current obstruction and extracting it. This shall include but not be limited to the rig, subs, and associated equipment. Appropriate tools shall be provided for the circumstances encountered. The work to complete the fishing shall be per line item "**Fishing**".
- C. Measurement: Measurement for payment shall be made by the delivery of the magnet to extract the obstruction as satisfactorily completed and accepted by the Division.
- D. Payment: Payment for the above-described work, which includes all labor, materials, and equipment necessary to supply the magnet to extract the obstruction, shall be made at the per unit price per each for "**Magnet**".

LOGGING

- A. Description: This work consists of all labor, equipment, and material necessary to determine the total depth of the well and the casing, if a packer is present (along with its depth and thickness), determine bond quality behind the casing and the free point of the casing. The Log should also confirm zones of gas production and formation tops for cementing purposes. All cement plug depth and thicknesses will be based on log data of the first well plugged on the site.
- B. Execution: The Contractor shall complete the logging of the well bore, casing, tubing, packer, and/or cement to the depth of the existing well bore, casing, tubing, packer, and/or cement. The methods of logging to be used shall be as indicated on the individual plugging plan and may include but not be limited to **gamma ray (GR), casing collar locator (CCL), temperature, bond, and caliper log.** Prior to use, the Contractor shall propose the method of logging and shall be approved by the Division.

- C. Measurement: Measurement for payment shall be made by field inspection of units satisfactorily completed and accepted by the Division. **A copy of the log shall be provided with the invoice as backup documentation.**
- D. Payment: Payment for the above-described work, which includes all labor, materials, and equipment necessary for the investigation of the well, shall be included at the per unit price per each for "Logging."

SHOOTING

- A. Description: This work consists of all labor, equipment, and material necessary to sever/shoot a casing or tubing at a determined depth for the purpose of removing the casing or tubing string by the means of shooting.
- B. Execution: The Contractor shall complete the shooting of the casing or tubing at a depth approved by the Division. This work shall include logging the well with a standard logging suite at the discretion of the Division to locate free point of casing or tubing in the well.

The Contractor shall propose the material and method for shooting of the casing or tubing, which shall be approved by the Division.

- C. Measurement: Measurement for payment shall be made by field inspection of units satisfactorily completed and accepted by the Division. **A copy of the log shall be provided with the invoice as backup documentation.**
- D. Payment: Payment for the above-described work, which includes all labor, materials, equipment necessary for the shooting the casing or tubing made at the unit price per each for "Shooting".

SEVERING

- A. Description: This work consists of all labor, equipment, and material necessary to sever a casing at a determined depth for the purpose of removing the casing string from the wellbore.
- B. Execution: The Contractor shall complete the severing of the casing at a depth approved by the Division. The Contractor shall propose the material and method for severing of the casing, which shall be approved by the Division. This includes, but is not limited to, locating free point, ripping, shooting, or cutting.
- C. Measurement: Measurement for payment shall be made by field inspection of units satisfactorily completed and accepted by the Division. **If applicable, a copy of the log shall be provided with the invoice as backup documentation.**
- D. Payment: Payment for the above-described work, which includes all labor, materials, and

equipment necessary for the severing the casing made at the unit price per each for "Severing".

NINE SACK GROUT

A. **Description:** This work shall include furnishing all labor, materials, equipment, and supplies necessary to plug the well as specified in the **Plugging Plan**.

B. **Materials:** Nine Sack Grout shall consist of the following materials and requirements:

Constituent	SSD Weight (lbs.)	Volume (ft.³)
Cement Type I-II	846.00	4.30
Sand	2550.00	15.54
Water	417.00	6.68

(SSD means saturated surface dry)

1. Cement Type I-II: Cement shall conform to ODOT CMS Item 701.02 and 701.04.

2. Sand: Sand shall be in accordance with ASTM C150.

3. Water: Water shall be in accordance with ASTM C1602.

The grout shall contain a maximum of 1% entrapped air.

Grout shall have a water to cement ratio (W/C) equal to 0.50 and an overall unit weight of 142.30 pounds per cubic foot.

Slump tests may be done at the discretion of the Division. Slump requirements shall be determined in the field at the time of construction.

The Division has accounted for excess materials due to loss in the wellbore in the quantities on the **Quantity Sheet**.

C. **Installation:** **The Contractor shall notify the Division at least 24 hours in advance of placing grout.** The surface plug shall be grouted to the depth described in the **Plugging Plan**.

Well preparation and circulation shall be achieved as detailed in the "**Well Preparation & Plugging**" line item and the **Plugging Plan**.

D. **Setting:** Setting times shall be completed as described in the **Plugging Plan**. For the casing any void space between the top of the grout and the top of the casing shall be filled to achieve a level grout line with the top of the casing. This shall be done at no additional cost to the Division.

E. **Measurement:** Measurement for payment for the above-described work shall be based upon

material quantities satisfactorily installed as well as delivery tickets furnished to the Division.

- F. Payment: Payment for all the above-described work shall be made at the unit price per cubic yard for "**Nine Sack Grout.**"

LOST CIRCULATION MATERIALS

- A. Description: This work shall include furnishing all labor, materials, equipment, and supplies necessary to expose portions of the well bore to lost circulation materials (LCM) as determined necessary. Lost circulation materials shall be implemented to aid in obtaining well bore circulation prior to any cementing operations.
- B. Materials: Lost circulation materials shall be selected by the Contractor based on site conditions encountered and proposed to the Division for approval.
- C. Measurement: Measurement for payment shall be based on the actual quantity of sacks of lost circulation materials satisfactorily placed and shall be verified with delivery tickets. For estimating purposes, it has been assumed that one (1) sack is equal to fifty (50) pounds.
- D. Payment: Payment for all the above-described work shall be made at the unit price per sack for "**Lost Circulation Materials**".

DRILLING MUD

- A. Description: The work covered by this section shall consist of furnishing all labor, equipment, and material necessary to provide and use a water-based drilling mud for the drilling and plugging process of the well.
- B. Materials: Based on the onsite conditions the Contractor shall propose a water-based drilling mud for approval from the Division. Once a material is approved, the Division will require a minimum quantity be maintained at the site during the plugging project based on circumstances encountered.
- C. Measurement: Measurement for payment for the above-described work shall be made by the actual quantity of sacks (50 lbs) of additives for the water-based drilling mud used to successfully plug the orphan well.
- D. Payment: Payment for the above work shall be made at the unit price per sack for "**Drilling Mud.**"



SCOPE OF WORK
Gallia 6F PROJECT
QUICKLE FARM
 Gallia County, Springfield Township

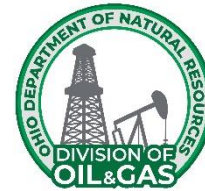

APPENDIX I – OHIO ONE-CALL

THE FOLLOWING ARE REPORTABLE INCIDENTS: (OAC 1501:9-8-02)

TYPE OF INCIDENT <small>(All Incident types associated with production operation or other activity regulated under Chapter 1509)</small>	QUANTITY <small>(GAL, BBL, PPM)</small> NOTE: 1 Barrel = 42 US Gallons	ADDITIONAL FACTORS
Release of Gas	<u>Any amount</u>	Resulting from a Blow out; OR
		Uncontrolled Pop-off Valve (in Urban Area); OR
		Any gas release that is a threat to public safety
Release of Hydrogen Sulfide(H₂S) Gas <small>(within the Working Area)</small>	Exceeding 20 ppm (Sustained airborne concentration); For duration > 10 min	OR any H ₂ S release resulting in injury or death of person
Fire / Explosion	N/A	In which a reporting person has called an emergency responder (9-1-1 or Fire Dept)
Release of Oil, Condensate, or Materials Saturated with Oil or Condensate	> 210 US gallons in any 24-hr period (Estimated)	AND the release is OUTSIDE secondary containment & into the environment
Release of Oil, Condensate, or Materials Saturated with Oil or Condensate	> 25 US gallons in any 24-hr period (Estimated); AND the release is outside secondary containment and into the environment	In an urban area; OR
		In an Emergency Management Zone of a surface water public drinking supply; OR
		In a 5-year time of travel with a groundwater-based public drinking supply; OR
		In a 100-year flood hazard area as delineated on the federal emergency management agency's (FEMA) national flood insurance rate map
Release of Refined Oil Products <small>(EX: oil-based drilling fluid, petroleum distillate, spent or unused paraffin solvent, gasoline, fuel oil, diesel fuel, or lubricants)</small>	> 25 US gallons in any 24-hr period	AND the release is OUTSIDE secondary containment & into the environment
Release of Oil, Condensate, or Materials Saturated with Oil or Condensate; OR Refined Oil Products	<u>Any amount</u>	That enters waters of the state in an amount that causes a film or sheen on the surface of the water
Release of Brine or Semi-Solid Waste <small>(EX: drilling mud, sludge, or tank bottom sediments)</small>	> 42 US gallons in any 24-hr period	AND the release is OUTSIDE secondary containment & into the environment
Release of Brine from a Vehicle, Vessel, Railcar, or Container	> 42 US gallons	AND is operated by a person to whom a registration certificate has been issued (ORC 1509.222), or to whom a resolution has been issued (ORC 1509.226)
		AND enters the environment

**Release of Hazardous Substance (HS)/
Extremely Hazardous Substance (EHS);
OR Mixture or Solution including a HS
or EHS**

An amount Equal to or > than applicable reportable quantities listed in 40CFR tables; in any 24-hr period

If the amount of one or more HS or EHS released is in an **unknown** mixture or solution, notify when the total amount of the mixture or solution released is equal to or > than the reportable quantity for the HS or EHS with the **lowest** reportable quantity

List available at:
http://oilandgas.ohiodnr.gov/portals/oilgas/pdf/emergency/list_of_lists.pdf

Code of Federal Regulations (C.F.R.) References:
HS- Appendix A 40 CFR Part 302.4
EHS- Appendix A 40 CFR Part 355

THE FOLLOWING ARE NOT REPORTABLE INCIDENTS: (OAC 1501:9-8-02 (A)(7))

1. Controlled flaring or controlled burns authorized under Chapter 1509. of the Revised Code or under 1501:9 of the Administrative Code or authorized by the terms and conditions of a permit issued under Chapter 1509. of the Revised Code;
2. Properly functioning emission control devices authorized pursuant to Revised Code Section 3704.03;
3. Subsurface detonation of perforation-guns;
4. Seismic shots;
5. Controlled blasting for well site construction

Date Last Edited & Printed: 9/27/2018



**SCOPE OF WORK
GALLIA #6 PROJECT
Quickle Farms #1 Well Site
Gallia County, Springfield Township**

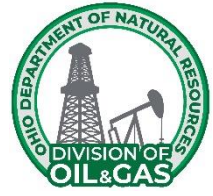

**APPENDIX II: Photos
& Well Records**

**Quickle Farms #1
34-053-9-0012-00-00
Gallia Co, Springfield Twp**



EDIT DATE: 4/27/2026 11:50 AM EDIT BY: 10167999 DRAWING FILE: \\ORPHAN WELL PROGRAM\ENGINEERING\GALLIA\GALLIA 6\GALLIA 6.DWG

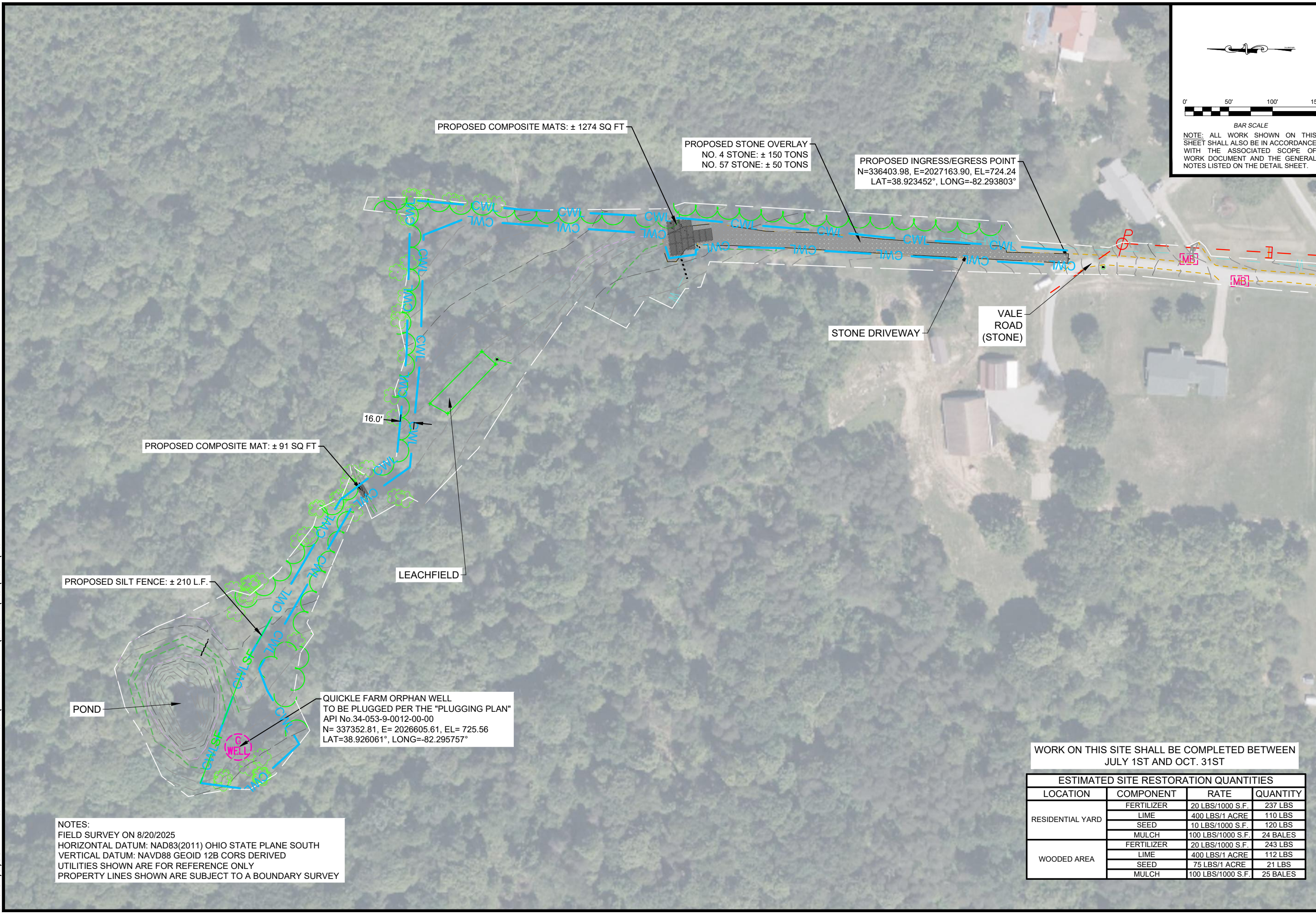

PROPOSED COMPOSITE MATS: ± 1274 SQ FT

PROPOSED STONE OVERLAY
NO. 4 STONE: ± 150 TONS
NO. 57 STONE: ± 50 TONS

PROPOSED INGRESS/EGRESS POINT
N=336403.98, E=2027163.90, EL=724.24
LAT=38.923452°, LONG=-82.293803°

STONE DRIVEWAY

VALE ROAD
(STONE)

PROPOSED COMPOSITE MAT: ± 91 SQ FT

16.0'

PROPOSED SILT FENCE: ± 210 L.F.

LEACHFIELD

POND

QUICKLE FARM ORPHAN WELL
TO BE PLUGGED PER THE "PLUGGING PLAN"
API No.34-053-9-0012-00-00
N= 337352.81, E= 2026605.61, EL= 725.56
LAT=38.926061°, LONG=-82.295757°

WORK ON THIS SITE SHALL BE COMPLETED BETWEEN
JULY 1ST AND OCT. 31ST

NOTES:
FIELD SURVEY ON 8/20/2025
HORIZONTAL DATUM: NAD83(2011) OHIO STATE PLANE SOUTH
VERTICAL DATUM: NAVD88 GEOID 12B CORS DERIVED
UTILITIES SHOWN ARE FOR REFERENCE ONLY
PROPERTY LINES SHOWN ARE SUBJECT TO A BOUNDARY SURVEY

ESTIMATED SITE RESTORATION QUANTITIES			
LOCATION	COMPONENT	RATE	QUANTITY
RESIDENTIAL YARD	FERTILIZER	20 LBS/1000 S.F.	237 LBS
	LIME	400 LBS/1 ACRE	110 LBS
	SEED	10 LBS/1000 S.F.	120 LBS
	MULCH	100 LBS/1000 S.F.	24 BALES
WOODED AREA	FERTILIZER	20 LBS/1000 S.F.	243 LBS
	LIME	400 LBS/1 ACRE	112 LBS
	SEED	75 LBS/1 ACRE	21 LBS
	MULCH	100 LBS/1000 S.F.	25 BALES



DIVISION OF OIL & GAS
RESOURCES MANAGEMENT
IDLE & ORPHAN WELL PROGRAM
<http://oilandgas.ohiodnr.gov>



SITE PLAN

GALLIA #6F
QUICKLE FARM
ORPHAN WELL SITE

REVISION

DESIGN UNIT

O&G ENGINEERING

DRAWN BY: A.D.K.

CHECKED BY: P.G.M.

DATE: 04/27/2026

SHEET NO.

GENERAL NOTES:

- UTILITY LINES AND APPURTENANCES ARE SHOWN AS LOCATED IN THE FIELD AND/OR AS REPORTED BY THE RESPECTIVE OWNERS. NEITHER THE NUMBER, TYPE, SIZE, OR LOCATION CAN BE GUARANTEED, AND IT IS THEREFORE, THE RESPONSIBILITY OF THE CONTRACTOR TO VERIFY ALL UTILITY LOCATIONS.
- THE CONTRACTOR SHALL BE RESPONSIBLE FOR ADEQUATELY PROTECTING THE EXISTING BURIED UTILITIES DURING CONSTRUCTION. THIS WORK SHALL BE CONSIDERED INCIDENTAL TO LINE ITEM "MOBILIZATION".**
- THE HORIZONTAL DATUM IS BASED ON NAD83 (2011) OHIO STATE PLANE SOUTH 3402, AND THE VERTICAL DATUM IS BASED ON NAVD88 GEOID 12A CORS DERIVED.
- PHOTO IMAGE DATE OBTAINED FROM OHIO GEOGRAPHICALLY REFERENCED INFORMATION PROGRAM (OGrip) FROM THE OHIO STATEWIDE IMAGERY PROGRAM (OSIP III).
- THE CONTRACTOR SHALL WORK WITHIN THE WORK LIMITS AT ALL TIMES DURING CONSTRUCTION.
- A FLAGGER IN EACH DIRECTION SHALL BE USED WHEN MATERIALS ARE BEING UNLOADED WITHIN THE ROAD RIGHT OF WAY.
- TREE AND OVERHANGING LIMB REMOVAL SHALL BE AS DESIGNATED BY THE DIVISION. REMOVALS SHALL PROVIDE THE CONTRACTOR WITH ADEQUATE SPACE REQUIRED TO COMPLETE THE PROJECT. TRIMMING OF TREES SHALL BE CONSIDERED INCIDENTAL TO LINE ITEMS AS SPECIFIED.
- THE DIVISION MUST BE PRESENT DURING ALL CLEARING OPERATIONS. NO TREES ARE TO BE REMOVED UNLESS DESIGNATED BY THE DIVISION.
- ANY REMOVED TREES AND VEGETATION SHALL BE PLACED INTO BRUSH PILES AT THE DISCRETION OF THE DIVISION.
- ALL STONE PLACED USING SIX (6) INCH MAXIMUM LIFTS, SHALL BE COMPACTED WITH A MINIMUM OF THREE (3) PASSES PER LIFT USING ONSITE EQUIPMENT.
- TIMBER MATS SHALL BE USED FOR TEMPORARY CONSTRUCTION ACCESS TO TRAVERSE WET AREAS AND/OR DRAINAGE COURSES.
- THE CONTRACTOR SHALL COORDINATE ALL WORK ASSOCIATED WITH CROSSING THE GAS LINE(S) SHOWN ON THIS SHEET WITH THE UTILITY OWNER PRIOR TO MOBILIZING EQUIPMENT. A QUANTITY OF TIMBER MATS HAS BEEN LISTED ON THE QUANTITY SHEET FOR THESE PURPOSES. TIMBER MATS SHALL BE PLACED AT THE DISCRETION OF THE UTILITY OWNER. WHETHER MATS ARE REQUIRED TO BE PLACED DIRECTLY OVERTOP OF THE UTILITY AND/OR PLACED AS AN AIR BRIDGE, PAYMENT WILL BE MADE PER LINE ITEM "TIMBER MATS".**
- ALL COMPOSITE MATTING INSTALLED SHALL BE INTERLOCKED PER THE MANUFACTURER'S REQUIREMENTS. IN AREAS WHERE POOR SUBGRADE IS ENCOUNTERED MATS CAN BE STACKED OVER TOP OF ONE ANOTHER AT THE DISCRETION OF THE DIVISION.
- SEDIMENT CONTROLS SHALL BE PLACED AT THE DISCRETION OF THE DIVISION.

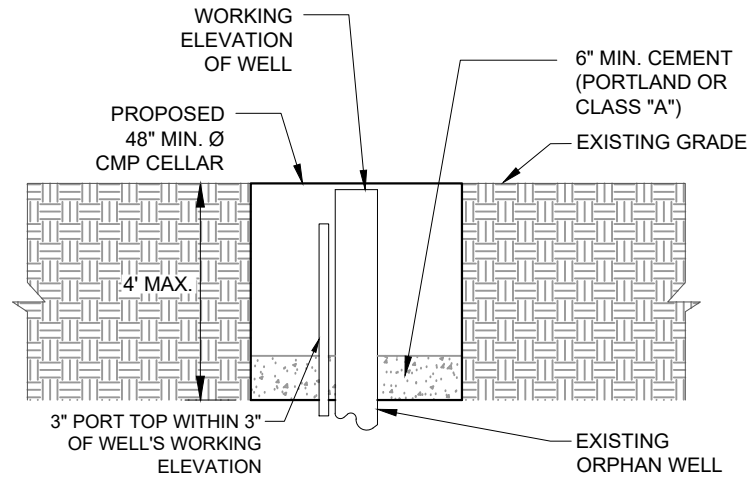

NOTES:
 ALL WORK & MATERIAL ASSOCIATED WITH THE INSTALLATION & REMOVAL OF THE CELLAR SHALL BE CONSIDERED INCIDENTAL TO LINE ITEM "WELL HEAD CONTROL".

TEMPORARY CELLAR
 NOT TO SCALE



W21-1
 (500' FROM W20-7,
 BOTH SIDES OF THE
 ENTRANCE)



W20-7
 COVER OR TURN DURING EVENINGS
 OR WHEN BOTH LANES ARE OPEN
 (500' FROM FLAGGER, BOTH SIDES OF
 ENTRANCE)

NOTES:

- THIS WORK SHALL BE PER THE GENERAL SPECIFICATIONS, PART 7: MAINTENANCE OF TRAFFIC AND SHALL BE INCIDENTAL TO LINE ITEM "MOBILIZATION" FOR EACH SITE, UNLESS OTHERWISE NOTED. **THIS WORK SHALL INCLUDE ALL REQUIRED PERMITS FROM THE LOCAL ROAD AUTHORITIES.**
- ALL SIGNS MAY BE MOUNTED PORTABLE MOUNTS.
- CONTRACTOR SHALL FOLLOW THE MANUAL OF UNIFORM TRAFFIC CONTROL DEVICES (MUTCD) FIGURE 6H-1, IN BOTH DIRECTIONS ALONG THE ROADWAY. W21-1 SHALL BE IN PLACE AS SOON AS THE CONTRACTOR ARRIVES TO THE SITE EACH DAY.
- CONTRACTOR SHALL FOLLOW THE MANUAL OF UNIFORM TRAFFIC CONTROL DEVICES (MUTCD) FIGURE 6H-13, LANE CLOSURE ON A TWO-LANE ROAD USING FLAGGERS (TA-13).
- FLAGGERS SHALL HAVE PROPER COMMUNICATION DEVICES AND SHALL BE POSITIONED 20' FROM EACH EDGE OF THE CONSTRUCTION WORK LIMITS. ANY VARIATION MUST BE APPROVED PER LOCATION. **TEMPORARY CLOSURES SHALL NOT BE COMPLETED WITHOUT A FLAGGER.**
- TEMPORARY CLOSURES SHALL BE MINIMIZED TO LESS THAN 20 MINUTES AND THEN THE ROAD SHALL BE FULLY REOPENED TO TRAFFIC.
- ANY WORK IN THE ROADWAY THAT IS REQUIRING MORE THAN 20 MINUTES SHALL BE COMPLETED PER GENERAL SPECIFICATIONS, PART 7: MAINTENANCE OF TRAFFIC WITH THE PROPER PERMITS FROM THE LOCAL ROAD AUTHORITIES AND APPROVAL FROM THE DIVISION.

FLAGGER & CONSTRUCTION SIGNAGE NOTES
 NOT TO SCALE

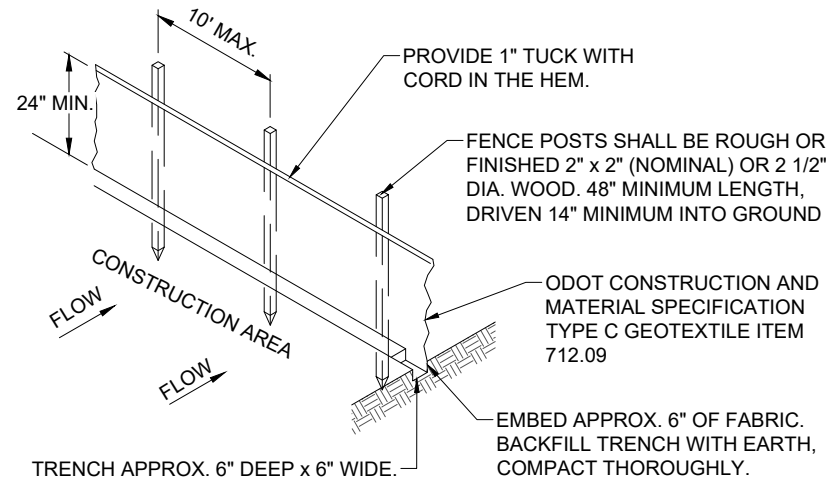

NOTES:
 1. FABRIC TO BE FASTENED SECURELY TO FENCE POST AS PER MANUFACTURER'S RECOMMENDATIONS.
 2. ENDS OF INDIVIDUAL ROLLS OF FABRIC SHALL BE SECURELY FASTENED TO A COMMON POST OR OVERLAPPED 3" MIN.

SILT FENCE DETAIL
 NOT TO SCALE

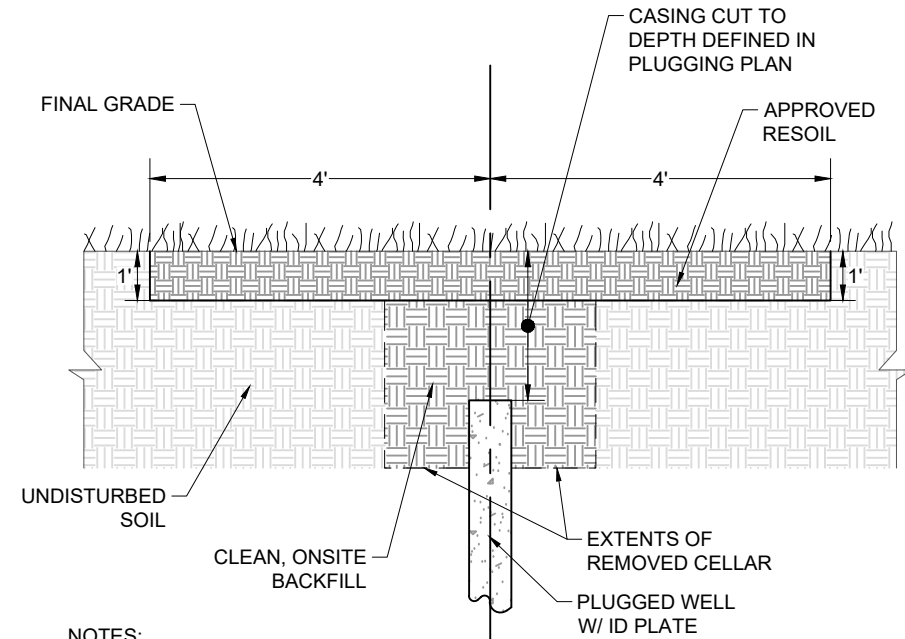

NOTES:

- ANY REMOVED MATERIAL FROM AROUND THE WELL HEAD SHALL BE SEGREGATED TO PREVENT ADDITIONAL CONTAMINATION.
- ONCE THE WELL IS CUT BELOW GRADE, AN EIGHT (8) FOOT BY EIGHT (8) FOOT AREA, ONE (1) FOOT DEEP SHALL BE EXCAVATED AROUND THE WELL HEAD & REPLACED WITH "APPROVED RESOIL".
- REMOVED MATERIAL SHALL BE DISPOSED OF PER LINE ITEM "CONTAMINATED MATERIAL DISPOSAL".
- PRIOR TO DELIVERY TO THE SITE OF "APPROVED RESOIL", ON SITE TOPSOIL MAY BE UTILIZED AT THE APPROVAL OF THE DIVISION
- ALL WORK NOT INCLUDED IN "APPROVED RESOIL" OF "CONTAMINATED MATERIAL DISPOSAL" SHALL BE INCIDENTAL TO LINE ITEM "SITE RESTORATION".

WELL RESTORATION SECTION
 NOT TO SCALE

EDIT DATE: 4/27/2026 11:50 AM EDIT BY: 10167989 DRAWING FILE: \6. ORPHAN WELL PROGRAM\ENGINEERING\GALLIA\GALLIA #6\GALLIA 6.DWG



DIVISION OF OIL & GAS
 RESOURCES MANAGEMENT
 IDLE & ORPHAN WELL PROGRAM
<http://oilandgas.ohiodnr.gov>



DETAILS

GALLIA #6F
 QUICKLE FARM
 ORPHAN WELL SITE

REVISION	
DESIGN UNIT	O&G ENGINEERING
DRAWN BY:	A.D.K.
CHECKED BY:	P.G.M.
DATE:	04/27/2026
SHEET NO.	

EDIT DATE: 4/27/2026 11:50 AM EDIT BY: 10167989 DRAWING FILE: M:\ORPHAN WELL PROGRAM\ENGINEERING\GALLIA\GALLIA 6\GALLIA 6.DWG

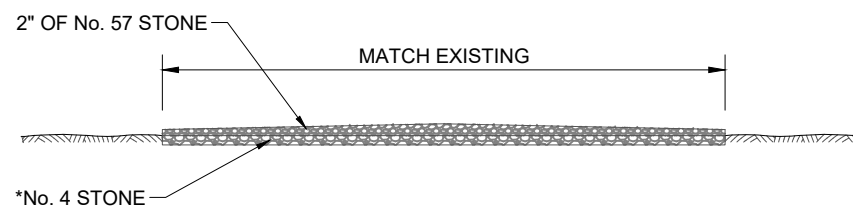

SECTION A-A'

NOTE:

THE EXISTING DRIVE WILL BE THE ONLY ACCESS TO THE PROJECT SITE(S). ACCESS FOR THE LANDOWNER SHALL BE MAINTAINED FOR THE DURATION OF THE PROJECT. AT THE DISCRETION OF THE DIVISION, No. 57 STONE SHALL BE PLACED ON THE EXISTING DRIVE UPON COMPLETION OF THE PROJECT. ALL OTHER ACCESS AREAS SHALL BE RESTORED PER LINE ITEM "SITE RESTORATION".

DRIVE ACCESS OVERLAY
NOT TO SCALE



DIVISION OF OIL & GAS
RESOURCES MANAGEMENT
IDLE & ORPHAN WELL PROGRAM
<http://oilandgas.ohiodnr.gov>



DETAILS

**GALLIA #6F
QUICKLE FARM
ORPHAN WELL SITE**

REVISION
DESIGN UNIT O&G ENGINEERING
DRAWN BY: A.D.K.
CHECKED BY: P.G.M.
DATE: 04/27/2026
SHEET NO. 4 OF 4



SCOPE OF WORK
Quantity Sheet
Gallia 6F Project



Gallia County, Unknown Township

Well Names
APIs

QUICKLE FARM
34053900120000

Line	Item	Description	Unit	Type	Cost	Qty	Estimate Total
Phase 1: Mobilization and Access							
1	1100	Mobilization	Each	Material		1.00	
2	1110	Demobilization	Each	Material		1.00	
3	1140	Clearing & Grubbing (EA -Lump Sum)	Each	Material		1.00	
4	1160	Silt Fence	Linear Ft.	Material		250.00	
5	1230	No. 4 Stone	Ton	Material		150.00	
6	1250	No. 57 Stone	Ton	Material		50.00	
7	1510	Road Mats	Sq. Ft.	Material		1365.00	
Phase 2: Well Site Safety							
8	2100	Site Safety	Each	Material		1.00	
9	2130	Secondary Containment	Each	Material		1.00	
10	2160	Well Head Control		Material		1.00	
11	2171	Well Kill Fluid	BBL	Material		100.00	
12	2240	Surface Casing (7")	Linear Ft.	Material		250.00	
Phase 3: Plugging							
13	3100	Well Preparation & Plugging (Quickle Far	Each	Material		1.00	
14	3160	Milling/Drillout	Hour	Material		8.00	
15	3240	Logging (GR/CCL/Temp/Bond/Caliper)	Each	Material		1.00	
16	3330	Tubing - 1.5 inch ID	Linear Ft.	Material		1.00	
17	3340	Approved Cement (Sack)	Each	Material		446.00	
18	3350	Cement Mixing & Pumping	Each	Material		6.00	
Phase 4: Site Clean-up and Restoration							
19	4100	Site Restoration	Each	Material		1.00	
20	4160	Approved Resoil	Ton	Material		60.00	
21	4420	Contaminated Material Disposal	Ton	Material		20.00	
22	4440	Salvage Material Disposal	Each	Material		1.00	
23	4460	Fluid Disposal	BBL	Material		300.00	
24	4470	Debris Removal and Disposal	Ton	Material		20.00	
Fixed Costs							
25	0800	Salvage Material Reimbursement	Each	Material	\$1,000.00	1.00	\$1,000.00
Contingency							
26	2181	Additional Circulation Fluid (Freshwater)	BBL	Material		200.00	
27	2360	Downhole Videography	Each	Material		1.00	
28	3140	Fishing	Hour	Material		8.00	
29	3170	Magnet	Each	Material		8.00	
30	3240	Logging (GR/CCL/Temp/Bond/Caliper)	Each	Material		1.00	
31	3250	Shooting	Each	Material		1.00	
32	3260	Perforating (First Run)	Each	Material		1.00	
33	3290	Severing	Each	Material		1.00	
34	3380	Nine Sack Grout	Cubic Yd.	Material		10.00	
35	3450	Lost Circulation Materials (Sack)	Each	Material		20.00	
36	3460	Drilling Mud (Sack)	Each	Material		20.00	

Note: This quantity sheet is provided for reference only. The Contractor's Offer must be submitted online through OhioBuys (<https://procure.ohio.gov/bidders-and-suppliers>). Quantities are only an estimate. Payment shall be based on quantities satisfactorily completed.

Each contractor is responsible for logging into OhioBuys and submitting an offer that is responsive to all amendments issued. All offers submitted prior to an amendment being issued shall become null/void and not considered in the opening. All amendments shall become part of the Scope of Work.

Offers must be fully submitted online through OhioBuys (<https://procure.ohio.gov/bidders-and-suppliers>) not later than,

"General Decision Number: OH20260001 01/02/2026

Superseded General Decision Number: OH20250001

State: Ohio

Construction Types: Heavy and Highway

Counties: Ohio Statewide.

Heavy and Highway Construction Projects

Modification Number	Publication Date
0	01/02/2026

BROH0001-001 06/01/2024

DEFIANCE, FULTON (Excluding Fulton, Amboy & Swan Creek Townships), HENRY (Excluding Monroe, Bartlow, Liberty, Washington, Richfield, Marion, Damascus & Townships & that part of Harrison Township outside corporate limits of city of Napoleon), PAULDING, PUTNAM and WILLIAMS COUNTIES

	Rates	Fringes
Bricklayer, Stonemason.....	\$ 33.39	20.06

BROH0001-004 06/01/2023		

	Rates	Fringes
CEMENT MASON/CONCRETE FINISHER...	\$ 32.40	19.30

BROH0003-002 06/01/2024		

FULTON (Townships of Amboy, Swan Creek & Fulton), HENRY (Townships of Washington, Damascus, Richfield, Bartlow, Liberty, Harrison, Monroe, & Marion), LUCAS and WOOD (Townships of Perrysburg, Ross, Lake, Troy, Freedom, Montgomery, Webster, Center, Portage, Middleton, Plain, Liberty, Henry, Washington, Weston, Milton, Jackson & Grand Rapids) COUNTIES

	Rates	Fringes
Bricklayer, Stonemason.....	\$ 33.39	20.06

BROH0005-003 06/01/2020		

CUYAHOGA, LORAIN & MEDINA (Hinckley, Granger, Brunswick, Liverpool, Montville, York, Homer, Harrisville, Chatham, Litchfield & Spencer Townships and the city of Medina)

	Rates	Fringes
BRICKLAYER		
BRICKLAYERS; CAULKERS;		
CLEANERS; POINTERS; &		
STONEMASONS.....	\$ 36.64	17.13
SANDBLASTERS.....	\$ 36.39	17.13
SEWER BRICKLAYERS & STACK		
BUILDERS.....	\$ 36.64	17.13

SWING SCAFFOLDS.....\$ 37.14 17.13

BROH0006-005 06/01/2024

CARROLL, COLUMBIANA (Knox, Butler, West & Hanover Townships),
STARK & TUSCARAWAS

Rates Fringes

Bricklayer, Stonemason.....\$ 33.39 20.06

BROH0007-002 06/01/2024

LAWRENCE

Rates Fringes

Bricklayer, Stonemason.....\$ 33.39 20.06

BROH0007-005 06/01/2023

PORTAGE & SUMMIT

Rates Fringes

BRICKLAYER.....\$ 32.40 19.30

BROH0007-010 06/01/2024

PORTAGE & SUMMIT

Rates Fringes

MASON - STONE.....\$ 33.39 20.06

BROH0008-001 06/01/2024

COLUMBIANA (Salem, Perry, Fairfield, Center, Elk Run,
Middleton, & Unity Townships and the city of New Waterford),
MAHONING & TRUMBULL

Rates Fringes

BRICKLAYER.....\$ 33.39 20.06

BROH0009-002 06/01/2024

BELMONT & MONROE COUNTIES and the Townships of Warren & Mt.
Pleasant and the Village of Dillonvale in JEFFERSON COUNTY

Rates Fringes

Bricklayer, Stonemason.....\$ 33.39 20.06
Refractory.....\$ 31.45 19.01

BROH0010-002 06/01/2024

COLUMBIANA (St. Clair, Madison, Wayne, Franklin, Washington,
Yellow Creek & Liverpool Townships) & JEFFERSON (Brush Creek &
Saline Townships)

	Rates	Fringes
Bricklayer, Stonemason.....	\$ 33.39	20.06

BROH0014-002 06/01/2024		

HARRISON & JEFFERSON (Except Mt. Pleasant, Warren, Brush Creek, Saline & Salineville Townships & the Village of Dillonvale)

	Rates	Fringes
Bricklayer, Stonemason.....	\$ 33.39	20.06

BROH0016-002 06/01/2023		

ASHTABULA, GEAUGA, and LAKE COUNTIES

	Rates	Fringes
Bricklayer, Stonemason.....	\$ 32.40	19.30

BROH0018-002 06/01/2024		

BROWN, BUTLER, CLERMONT, HAMILTON, PREBLE (Gasper, Dixon, Israel, Lanier, Somers & Gratis Townships) & WARREN COUNTIES:

	Rates	Fringes
Bricklayer, Stonemason.....	\$ 33.39	20.06

BROH0022-004 06/01/2024		

CHAMPAIGN, CLARK, CLINTON, DARKE, GREENE, HIGHLAND, LOGAN, MIAMI, MONTGOMERY, PREBLE (Jackson, Monroe, Harrison, Twin, Jefferson & Washington Townships) and SHELBY COUNTIES

	Rates	Fringes
Bricklayer, Stonemason.....	\$ 33.39	20.06

BROH0032-001 06/01/2024		

GALLIA & MEIGS

	Rates	Fringes
Bricklayer, Stonemason.....	\$ 33.39	20.06

BROH0035-002 06/01/2024		

ALLEN, AUGLAIZE, MERCER and VAN WERT COUNTIES

	Rates	Fringes
Bricklayer, Stonemason.....	\$ 33.39	20.06

BROH0039-002 06/01/2024		

ADAMS & SCIOTO

Rates	Fringes
-------	---------

Bricklayer, Stonemason.....\$ 33.39 20.06

BROH0040-003 06/01/2024

ASHLAND, CRAWFORD, HARDIN, HOLMES, MARION, MORROW, RICHLAND,
WAYNE and WYANDOT (Except Crawford, Ridge, Richland & Tymochtee
Townships) COUNTIES

Rates Fringes

Bricklayer, Stonemason.....\$ 33.39 20.06

FOOTNOTE: Layout Man and Sawman rate: \$1.00 per hour above
journeyman rate.

Free standing stack work ground level to top of stack;
Sandblasting and laying of carbon masonry material in swing
stage and/or scaffold; Ramming and spading of plastics and
gunniting: \$1.50 per hour above journeyman rate.

""Hot"" work: \$2.50 above journeyman rate.

BROH0044-002 06/01/2024

Rates Fringes

Bricklayer, Stonemason
COSHOCOTON, FAIRFIELD,
GUERNSEY, HOCKING, KNOX,
KICKING, MORGAN,
MUSKINGUM, NOBLE (Beaver,
Buffalo, Seneca & Wayne
Townships) & PERRY
COUNTIES:.....\$ 33.39 20.06

BROH0045-002 06/01/2023

FAYETTE, JACKSON, PIKE, ROSS and VINTON COUNTIES

Rates Fringes

Bricklayer, Stonemason.....\$ 35.39 17.47

BROH0046-002 06/01/2024

ERIE, HANCOCK, HURON, OTTAWA, SANDUSKY, SENECA, WOOD (Perry &
Bloom Townships) and WYANDOT (Tymochtee, Crawford, Ridge &
Richland Townships) COUNTIES & the Islands of Lake Erie north
of Sandusky

Rates Fringes

Bricklayer, Stonemason.....\$ 33.39 20.06

FOOTNOTE: Layout Man and Sawman rate: \$1.00 per hour above
journeyman rate.

Free standing stack work ground level to top of stack;
Sandblasting and laying of carbon masonry material in swing
stage and/or scaffold; Ramming and spading of plastics and
gunniting: \$1.50 per hour above journeyman rate.

""Hot"" work: \$2.50 above journeyman rate.

BROH0052-001 06/01/2024

ATHENS COUNTY

	Rates	Fringes
Bricklayer, Stonemason.....	\$ 33.39	20.06

BROH0052-003 06/01/2024		

NOBLE (Brookfield, Noble, Center, Sharon, Olive, Enoch, Stock, Jackson, Jefferson & Elk Townships) and WASHINGTON COUNTIES

	Rates	Fringes
Bricklayer, Stonemason.....	\$ 33.39	20.06

BROH0055-003 06/01/2024		

DELAWARE, FRANKLIN, MADISON, PICKAWAY and UNION COUNTIES

	Rates	Fringes
Bricklayer, Stonemason.....	\$ 33.39	20.06

CARP0002-024 05/01/2025		

BROWN, BUTLER, CHAMPAIGN, CLARK, CLERMONT, CLINTON, DARKE, GREENE, HAMILTON, LOGAN, MIAMI, MONTGOMERY, PREBLE, SHELBY & WARREN

	Rates	Fringes
Carpenter & Piledrivermen.....	\$ 35.94	23.59
Diver.....	\$ 40.58	9.69

CARP0171-001 05/01/2025		

MAHONING & TRUMBULL

	Rates	Fringes
CARPENTER.....	\$ 33.19	25.02

CARP0171-002 05/01/2025		

BELMONT, COLUMBIANA, HARRISON, JEFFERSON & MONROE

	Rates	Fringes
CARPENTER.....	\$ 32.50	26.19

CARP0200-002 05/01/2025		

ADAMS, ATHENS, DELAWARE, FAIRFIELD, FAYETTE, FRANKLIN, GALLIA, GUERNSEY, HIGHLAND, HOCKING, JACKSON, LAWRENCE, LICKING, MADISON, MARION, MEIGS, MORGAN, MUSKINGUM, NOBLE, PERRY, PICKAWAY, PIKE, ROSS, SCIOTO, UNION, VINTON and WASHINGTON COUNTIES

	Rates	Fringes
CARPENTER.....	\$ 35.94	23.59

Diver.....	\$ 39.41	10.40
PILED RIVERMAN.....	\$ 35.94	23.59

CARP0285-001 05/01/2025

CARROLL, STARK, TUSCARAWAS and WAYNE

	Rates	Fringes
CARPENTER.....	\$ 34.07	24.28

CARP0285-002 05/01/2025

COSHOCTON, HOLMES, KNOX & MORROW

	Rates	Fringes
CARPENTER.....	\$ 33.38	24.69

CARP0285-008 05/01/2025

MEDINA, PORTAGE & SUMMIT

	Rates	Fringes
CARPENTER.....	\$ 37.18	25.07

CARP0351-005 05/01/2025

LUCAS & WOOD

	Rates	Fringes
CARPENTER.....	\$ 35.44	27.56

CARP0351-006 05/01/2025

	Rates	Fringes
CARPENTER DEFIANCE, FULTON, HANCOCK, HENRY, PAULDING & WILLIAMS COUNTIES.....	\$ 32.05	26.13

CARP0372-002 05/01/2025

ALLEN, AUGLAIZE, HARDIN, MERCER, PUTNAM & VAN WERT

	Rates	Fringes
CARPENTER.....	\$ 31.80	26.33

CARP0435-005 05/01/2025

ASHTABULA, CUYAHOGA, GEauga & LAKE

	Rates	Fringes
CARPENTER.....	\$ 38.57	24.64

CARP0735-001 05/01/2025

ASHLAND, HURON & RICHLAND

	Rates	Fringes
--	-------	---------

CARPENTER.....\$ 34.67 23.57

 CARP0735-002 05/01/2025

LORAIN

	Rates	Fringes
CARPENTER.....	\$ 38.42	24.01

CARP0735-004 05/01/2025		

ERIE

	Rates	Fringes
CARPENTER.....	\$ 36.71	24.14

CARP0744-001 05/01/2025		

CRAWFORD, OTTAWA, SANDUSKY, SENECA & WYANDOT

	Rates	Fringes
CARPENTER.....	\$ 33.74	27.05

CARP1090-002 05/01/2025		

ALLEN, AUGLAIZE, HARDIN, MERCER, PUTNAM, VAN WERT & WYANDOT

	Rates	Fringes
Piledrivermen & Diver's Tender...	\$ 35.94	28.39

DIVERS - \$250.00 per day		

CARP1090-003 05/01/2025		

BELMONT, HARRISON, & MONROE

	Rates	Fringes
Diver, Wet.....	\$ 58.52	24.91
Piledrivermen; Diver, Dry.....	\$ 39.01	24.91

CARP1090-004 05/01/2025		

CARROLL, STARK, TUSCARAWAS & WAYNE

	Rates	Fringes
Diver, Wet.....	\$ 49.82	25.40
Piledrivermen; Diver, Dry.....	\$ 33.21	25.40

CARP1090-005 05/01/2025		

ASHLAND, ASHTABULA, CUYAHOGA, ERIE, GEAUGA, HURON, LAKE, LORAIN, MEDINA, PORTAGE, RICHLAND & SUMMIT

	Rates	Fringes
Diver, Wet.....	\$ 54.51	27.50
Piledrivermen; Diver, Dry.....	\$ 36.34	27.50

CARP1090-006 05/01/2025

COSHOCTON, HOLMES, KNOX & MORROW

	Rates	Fringes
Diver, Wet.....	\$ 54.36	22.54
Piledrivermen; Diver, Dry.....	\$ 36.24	22.54

CARP1090-007 05/01/2025

MAHONING & TRUMBULL

	Rates	Fringes
Diver, Wet.....	\$ 50.85	24.82
Piledrivermen; Diver, Dry.....	\$ 33.90	24.82

CARP1090-008 05/01/2025

COLUMBIANA & JEFFERSON

	Rates	Fringes
PILEDRIVERMAN.....	\$ 39.01	24.91

CARP1090-009 05/01/2025

CRAWFORD, DEFIANCE, FULTON, HANCOCK, HENRY, LUCAS, OTTAWA,
PAULDING, SANDUSKY, SENECA, WILLIAMS & WOOD

	Rates	Fringes
Piledrivermen & Diver's Tender...\$	37.98	28.63

DIVERS - \$250.00 per day

ELEC0008-002 05/27/2024

DEFIANCE, FULTON, HANCOCK, HENRY, LUCAS, OTTAWA, PAULDING,
PUTNAM, SANDUSKY, SENECA, WILLIAMS & WOOD

	Rates	Fringes
CABLE SPLICER.....	\$ 38.98	18.96
ELECTRICIAN.....	\$ 48.40	4.5%+23.06

ELEC0032-003 06/01/2025

ALLEN, AUGLAIZE, HARDIN, LOGAN, MERCER, SHELBY, VAN WERT &
WYANDOT (Crawford, Jackson, Marseilles, Mifflin, Ridgeland,
Ridge & Salem Townships)

	Rates	Fringes
ELECTRICIAN.....	\$ 39.17	23.60

ELEC0038-002 04/28/2025

CUYAHOGA, GEAUGA (Bainbridge, Chester & Russell Townships) &
LORAIN (Columbia Township)

	Rates	Fringes
ELECTRICIAN		
Excluding Sound & Communications Work.....	\$ 46.63	24.92

FOOTNOTES;

- a. 6 Paid Holidays: New Year's Day; Memorial Day; July 4th; Labor Day; Thanksgiving Day; & Christmas Day
- b. 1 week's paid vacation for 1 year's service; 2 weeks' paid vacation for 2 or more years' service

 ELEC0038-008 04/28/2025

CUYAHOGA, GEAUGA (Bainbridge, Chester & Russell Townships) & LORAIN (Columbia Township)

	Rates	Fringes
Sound & Communication Technician		
Communications Technician...	\$ 34.30	14.95
Installer Technician.....	\$ 33.05	14.91

FOOTNOTES;

- a. 6 Paid Holidays: New Year's Day; Memorial Day; July 4th; Labor Day; Thanksgiving Day; & Christmas Day
- b. 1 week's paid vacation for 1 year's service; 2 weeks' paid vacation for 2 or more years' service

 ELEC0064-003 11/30/2025

COLUMBIANA (Butler, Fairfield, Perry, Salem & Unity Townships) MAHONING (Austintown, Beaver, Berlin, Boardman, Canfield, Ellsworth, Coitsville, Goshen, Green, Jackson, Poland, Springfield & Youngstown Townships), & TRUMBULL (Hubbard & Liberty Townships)

	Rates	Fringes
ELECTRICIAN.....	\$ 41.49	21.81

 ELEC0071-005 01/06/2025

ASHTABULA, CUYAHOGA, GEAUGA, LAKE & LORAIN

	Rates	Fringes
LINE CONSTRUCTION: Equipment Operator		
DOT/Traffic Signal & Highway Lighting Projects...	\$ 39.97	27%+8.00
Municipal Power/Transit Projects.....	\$ 49.46	27%+8.25
LINE CONSTRUCTION: Groundman		
DOT/Traffic Signal & Highway Lighting Projects...	\$ 31.10	27%+8.00
Municipal Power/Transit Projects.....	\$ 38.47	27%+8.25

LINE CONSTRUCTION:

Linemen/Cable Splicer		
DOT/Traffic Signal &		
Highway Lighting Projects...	\$ 43.89	27%+8.00
Municipal Power/Transit		
Projects.....	\$ 54.96	27%+8.25

ELEC0071-010 01/06/2025

Statewide

	Rates	Fringes
Line Construction		
Equipment Operator.....	\$ 40.44	4%+16.09
Groundman.....	\$ 29.07	4%+13.81
Lineman & Cable Splicers....	\$ 46.02	4%+17.20

ELEC0082-002 12/02/2024

CLINTON, DARKE, GREENE, MIAMI, MONTGOMERY, PREBLE & WARREN
(Wayne, Clear Creek & Franklin Townships)

	Rates	Fringes
ELECTRICIAN.....	\$ 38.00	22.49

ELEC0082-006 11/25/2024

CLINTON, DARKE, GREENE, MIAMI, MONTGOMERY, PREBLE & WARREN
(Wayne, Clear Creek & Franklin Townships)

	Rates	Fringes
Sound & Communication		
Technician		
Cable Puller.....	\$ 13.85	5.30
Installer/Technician.....	\$ 27.70	15.71

ELEC0129-003 02/24/2025

LORAIN (Except Columbia Township) & MEDINA (Litchfield & Liverpool Townships)

	Rates	Fringes
ELECTRICIAN.....	\$ 42.95	18.81

ELEC0129-004 02/24/2025

ERIE & HURON (Lyme, Ridgefield, Norwalk, Townsend, Wakeman, Sherman, Peru, Bronson, Hartland, Clarksfield, Norwich, Greenfield, Fairfield, Fitchville & New London Townships)

	Rates	Fringes
ELECTRICIAN.....	\$ 42.95	18.81

ELEC0141-003 06/02/2025

BELMONT COUNTY

	Rates	Fringes
CABLE SPLICER.....	\$ 42.94	27.74
ELECTRICIAN.....	\$ 39.25	31.23

ELEC0212-003 11/26/2018

BROWN, CLERMONT & HAMILTON

	Rates	Fringes
Sound & Communication Technician.....	\$ 24.35	10.99

ELEC0212-005 06/02/2025

BROWN, CLERMONT, and HAMILTON COUNTIES

	Rates	Fringes
ELECTRICIAN.....	\$ 38.05	22.97

ELEC0245-001 08/26/2024

ALLEN, HARDIN, VAN WERT & WYANDOT (Crawford, Jackson, Marseilles, Mifflin, Richland, Ridge & Salem Townships)

	Rates	Fringes
Line Construction		
Equipment Operator.....	\$ 32.95	28%+7.85
Groundman Truck Driver.....	\$ 20.59	28%+7.85
Lineman.....	\$ 47.07	28%+7.85

FOOTNOTE: a. Half day's Paid Holiday: The last 4 hours of the workday prior to Christmas or New Year's Day

ELEC0245-003 01/01/2025

DEFIANCE, FULTON, HANCOCK, HENRY, HURON, LUCAS, OTTAWA, PAULDING, PUTNAM, SANDUSKY, SENECA, WILLIAMS, and WOOD COUNTIES

	Rates	Fringes
Line Construction		
Cable Splicer.....	\$ 53.90	8.10+28%
Groundman/Truck Driver.....	\$ 20.51	8.10+28%
Heli-arc Welding.....	\$ 47.17	8.10+28%
Lineman.....	\$ 46.87	8.10+28%
Operator - Class 1.....	\$ 37.50	8.10+28%
Operator - Class 2.....	\$ 32.81	8.10+28%
Traffic Signal & Lighting Technician.....	\$ 42.18	8.10+28%

FOOTNOTE: a. 6 Observed Holidays: New Year's Day; Memorial Day; Independence Day; Labor Day; Thanksgiving Day; & Christmas Day. Employees who work on a holiday shall be paid at a rate of double their applicable classified straight-time rates for the work performed on such holiday.

ELEC0245-004 01/01/2025

ERIE COUNTY

	Rates	Fringes
Line Construction		
Cable Splicer.....	\$ 53.90	28%+8.10
Groundman/Truck Driver.....	\$ 20.51	28%+8.10
Lineman.....	\$ 46.87	28%+8.10
Operator - Class 1.....	\$ 37.50	28%+8.10
Operator - Class 2.....	\$ 32.81	28%+8.10

FOOTNOTE: a. 6 Observed Holidays: New Year's Day; Memorial Day; Independence Day; Labor Day; Thanksgiving Day; & Christmas Day. Employees who work on a holiday shall be paid at a rate of double their applicable classified straight-time rates for the work performed on such holiday.

 ELEC0246-001 10/28/2024

Carroll, Columbiana, Harrison and Jefferson Counties in Ohio; Brooke and Hancock Counties in West Virginia.

	Rates	Fringes
ELECTRICIAN.....	\$ 44.00	30.38%+24.31

FOOTNOTE: a. 1 1/2 Paid Holidays: The last scheduled workday prior to Christmas & 4 hours on Good Friday.

 ELEC0306-005 05/27/2024

MEDINA (Brunswick, Chatham, Granger, Guilford, Harrisville, Hinckley, Homer, Lafayette, Medina, Montville, Sharon, Spencer, Wadsworth, Westfield & York Townships), PORTAGE (Atwater, Aurora, Brimfield, Deerfield, Franklin, Mantua, Randolph, Ravenna, Rootstown, Shalersville, Streetsboro & Suffield Townships), SUMMIT & WAYNE (Baughman, Canaan, Chester, Chippewa, Congress, Green, Milton, & Wayne Townships)

	Rates	Fringes
CABLE SPLICER.....	\$ 46.81	20.95
ELECTRICIAN.....	\$ 42.55	20.95

 ELEC0317-002 06/02/2025

GALLIA & LAWRENCE

	Rates	Fringes
CABLE SPLICER.....	\$ 32.68	18.13
ELECTRICIAN.....	\$ 41.15	29.35

 ELEC0540-005 06/30/2025

CARROLL (Northern half, including Fox, Harrison, Rose & Washington Townships), COLUMBIANA (Knox Township), HOLMES, MAHONING (Smith Township), STARK, TUSCARAWAS (North of Auburn, Clay, Rush & York Townships), and WAYNE (South of Baughman,

Chester, Green & Wayne Townships) COUNTIES

	Rates	Fringes
ELECTRICIAN.....	\$ 39.86	29.19

ELEC0573-003 06/01/2025

ASHTABULA (Colebrook, Wayne, Williamsfield, Orwell & Windsor Townships), GEAUGA (Auburn, Middlefield, Parkman & Troy Townships), MAHONING (Milton Township), PORTAGE (Charlestown, Edinburg, Freedom, Hiram, Nelson, Palmyra, Paris & Windham Townships), and TRUMBULL (Except Liberty & Hubbard Townships)

	Rates	Fringes
ELECTRICIAN.....	\$ 42.20	23.37

ELEC0575-001 05/29/2023

ADAMS, FAYETTE, HIGHLAND, HOCKING, JACKSON (Bloomfield, Franklin, Hamilton, Jefferson, Lick, Madison, Scioto, Coal, Jackson, Liberty, Milton & Washington Townships), PICKAWAY (Deer Creek, Perry, Pickaway, Salt Creek & Wayne Townships), PIKE (Beaver, Benton, Jackson, Mifflin, Pebble, PeePee, Perry, Seal, Camp Creek, Newton, Scioto, Sunfish, Union & Marion Townships), ROSS, SCIOTO & VINTON (Clinton, Eagle, Elk, Harrison, Jackson, Richland & Swan Townships)

	Rates	Fringes
ELECTRICIAN.....	\$ 37.00	22.26

ELEC0648-001 09/01/2025

BUTLER and WARREN COUNTIES (Deerfield, Hamilton, Harlan, Massie, Salem, Turtle Creek, Union & Washington Townships)

	Rates	Fringes
CABLE SPLICER.....	\$ 30.50	18.23
ELECTRICIAN.....	\$ 38.00	24.162

ELEC0673-004 05/26/2025

ASHTABULA (Excluding Orwell, Colebrook, Williamsfield, Wayne & Windsor Townships), GEAUGA (Burton, Chardon, Claridon, Hambden, Huntsburg, Montville, Munson, Newbury & Thompson Townships) and LAKE COUNTIES

	Rates	Fringes
CABLE SPLICER.....	\$ 33.81	21.47
ELECTRICIAN.....	\$ 41.17	24.58

ELEC0683-002 06/02/2025

CHAMPAIGN, CLARK, DELAWARE, FAIRFIELD, FRANKLIN, MADISON, PICKAWAY (Circleville, Darby, Harrison, Jackson, Madison, Monroe, Muhlenberg, Scioto, Walnut & Washington Townships), and

UNION COUNTIES

	Rates	Fringes
CABLE SPLICER.....	\$ 44.00	26.40
ELECTRICIAN.....	\$ 43.00	26.37

 ELEC0688-003 05/30/2022

ASHLAND, CRAWFORD, HURON (Richmond, New Haven, Ripley & Greenwich Townships), KNOX (Liberty, Clinton, Union, Howard, Monroe, Middleberry, Morris, Wayne, Berlin, Pike, Brown & Jefferson Townships), MARION, MORROW, RICHLAND and WYANDOT (Sycamore, Crane, Eden, Pitt, Antrim & Tymochtee Townships) COUNTIES

	Rates	Fringes
ELECTRICIAN.....	\$ 32.30	21.83

 ELEC0972-002 06/01/2024

ATHENS, MEIGS, MONROE, MORGAN, NOBLE, VINTON (Brown, Knox, Madison, Vinton & Wilkesville Townships), and WASHINGTON COUNTIES

	Rates	Fringes
CABLE SPLICER.....	\$ 40.25	33.33
ELECTRICIAN.....	\$ 40.00	33.32

 ELEC1105-001 05/27/2024

COSHOCTON, GUERNSEY, KNOX (Jackson, Clay, Morgan, Miller, Milford, Hilliar, Butler, Harrison, Pleasant & College Townships), LICKING, MUSKINGUM, PERRY, and TUSCARAWAS (Auburn, York, Clay, Jefferson, Rush, Oxford, Washington, Salem, Perry & Bucks Townships) COUNTIES

	Rates	Fringes
ELECTRICIAN.....	\$ 39.60	24.41

 ENGI0018-003 05/01/2024

ASHTABULA, CUYAHOGA, ERIE, GEAUGA, LAKE, LORAIN, MEDINA, PORTAGE, and SUMMIT COUNTIES

	Rates	Fringes
POWER EQUIPMENT OPERATOR		
GROUP 1.....	\$ 45.63	16.41
GROUP 2.....	\$ 45.53	16.41
GROUP 3.....	\$ 44.49	16.41
GROUP 4.....	\$ 43.27	16.41
GROUP 5.....	\$ 37.98	16.41
GROUP 6.....	\$ 46.63	16.41
GROUP 7.....	\$ 46.63	16.41

OPERATING ENGINEER CLASSIFICATIONS

GROUP 1 - Air Compressor on Steel Erection; Barrier Moving Machine; Boiler Operator on Compressor or Generator when mounted on a Rig; Cableway; Combination Concrete Mixer & Tower; Concrete Plant (over 4 yd. Capacity); Concrete Pump; Crane (All Types, Including Boom Truck, Cherry Picker); Crane-Compact, Track or Rubber over 4,000 lbs. capacity; Cranes-Self Erecting, Stationary, Track or Truck (All Configurations); Derrick; Dragline; Dredge (Dipper, Clam or Suction); Elevating Grader or Euclid Loader; Floating Equipment (All Types); Gradall; Helicopter Crew (Operator-Hoist or Winch); Hoe (all types); Hoisting Engine on Shaft or Tunnel Work; Hydraulic Gantry (Lifting System); Industrial-Type Tractor; Jet Engine Dryer (D8 or D9) Diesel Tractor; Locomotive (Standard Gauge); Maintenance Operator Class A; Mixer, Paving (Single or Double Drum); Mucking Machine; Multiple Scraper; Piledriving Machine (All Types); Power Shovel; Prentice Loader; Quad 9 (Double Pusher); Rail Tamper (with auto lifting & aligning device); Refrigerating Machine (Freezer Operation); Rotary Drill, on Caisson work; Rough Terrain Fork Lift with Winch/Hoist; Side-Boom; Slip-Form Paver; Tower Derrick; Tree Shredder; Trench Machine (Over 24" wide); Truck Mounted Concrete Pump; Tug Boat; Tunnel Machine and/or Mining Machine; Wheel Excavator; and Asphalt Plant Engineer (Cleveland District Only).

GROUP 2 - Asphalt Paver; Automatic Subgrader Machine, Self-Propelled (CMI Type); Bobcat Type and/or Skid Steer Loader with Hoe Attachment Greater than 7,000 lbs.; Boring Machine More than 48"; Bulldozer; Endloader; Horizontal Directional Drill (Over 50,000 ft lbs thrust); Hydro Milling Machine; Kolman-type Loader (production type-Dirt); Lead Greaseman; Lighting & Traffic Signal Installation Equipment (includes all groups or classifications); Material Transfer Equipment (Shuttle Buggy) Asphalt; Pettibone-Rail Equipment; Power Grader; Power Scraper; Push Cat; Rotomill (all), Grinders & Planers of All types; Trench Machine (24" wide & under); Vermeer type Concrete Saw; and Maintenance Operators (Portage and Summit Counties Only).

GROUP 3 - A-Frame; Air Compressor on Tunnel Work (low pressure); Asphalt Plant Engineer (Portage and Summit Counties Only); Bobcat-type and/or Skid Steer Loader with or without Attachments; Highway Drills (all types); Locomotive (narrow gauge); Material Hoist/Elevator; Mixer, Concrete (more than one bag capacity); Mixer, one bag capacity (Side Loader); Power Boiler (Over 15 lbs. Pressure) Pump Operator installing & operating Well Points; Pump (4" & over discharge); Roller, Asphalt; Rotovator (lime soil stabilizer); Switch & Tie Tampers (without lifting & aligning device); Utility Operator (Small equipment); Welding Machines; and Railroad Tie Inserter/Remover; Articulating/straight bed end dumps if assigned (minus \$4.00 per hour).

GROUP 4 - Backfiller; Ballast Re-locator; Bars, Joint & Mesh Installing Machine; Batch Plant; Boring Machine Operator (48" or less); Bull Floats; Burlap & Curing Machine; Concrete Plant (capacity 4 yd. & under); Concrete Saw (Multiple); Conveyor (Highway); Crusher; Deckhand; Farm-type Tractor with attachments (highway); Finishing Machine; Fireperson, Floating Equipment (all types); Forklift; Form Trencher; Hydro Hammer expect masonry;

Hydro Seeder; Pavement Breaker; Plant Mixer; Post Driver; Post Hole Digger (Power Auger); Power Brush Burner; Power Form Handling Equipment; Road Widening Trencher; Roller (Brick, Grade & Macadam); Self-Propelled Power Spreader; Self-Propelled Power Subgrader; Steam Fireperson; Tractor (Pulling Sheepfoot, Roller or Grader); and Vibratory Compactor with Integral Power.

GROUP 5 - Compressor (Portable, Sewer, Heavy & Highway); Drum Fireperson (Asphalt Plant); Generator; Masonry Fork Lift; Inboard-Outboard Motor Boat Launch; Oil Heater (asphalt plant); Oiler/Helper; Power Driven Heater; Power Sweeper & Scrubber; Pump (under 4" discharge); Signalperson; Tire Repairperson; VAC/ALLS; Cranes - Compact, track or rubber under 4,000 pound capacity; fueling and greasing; and Chainmen.

GROUP 6 - Master Mechanic & Boom from 150 to 180.

GROUP 7 - Boom from 180 and over.

 ENGI0018-004 05/01/2024

ADAMS, ALLEN, ASHLAND, ATHENS, AUGLAIZE, BELMONT, BROWN, BUTLER, CARROLL, CHAMPAIGN, CLARK, CLERMONT, CLINTON, COSHOCTON, CRAWFORD, DARKE, DEFIANCE, DELAWARE, FAIRFIELD, FAYETTE, FRANKLIN, FULTON, GALLIA, GREENE, GUERNSEY, HAMILTON, HANCOCK, HARDIN, HARRISON, HENRY, HIGHLAND, HOCKING, HOLMES, HURON, JACKSON, JEFFERSON, KNOX, LAWRENCE, LICKING, LOGAN, LUCAS, MADISON, MARION, MEIGS, MERCER, MIAMI, MONROE, MONTGOMERY, MORGAN, MORROW, MUSKINGUM, NOBLE, OTTAWA, PAULDING, PERRY, PICKAWAY, PIKE, PREBLE, PUTNAM, RICHLAND, ROSS, SANDUSKY, SCIOTO, SENECA, SHELBY, STARK, TUSCARAWAS, UNION, VAN WERT, VINTON, WARREN, WASHINGTON, WAYNE, WILLIAMS, WOOD, and YANDOT COUNTIES

	Rates	Fringes
POWER EQUIPMENT OPERATOR		
GROUP 1.....	\$ 44.14	16.41
GROUP 2.....	\$ 44.02	16.41
GROUP 3.....	\$ 42.98	16.41
GROUP 4.....	\$ 41.80	16.41
GROUP 5.....	\$ 36.34	16.41
GROUP 6.....	\$ 45.14	16.41
GROUP 7.....	\$ 45.14	16.41

OPERATING ENGINEER CLASSIFICATIONS

GROUP 1 - Air Compressor on Steel Erection; Barrier Moving Machine; Boiler Operator on Compressor or Generator when mounted on a Rig; Cableway; Combination Concrete Mixer & Tower; Concrete Plant (over 4 yd. Capacity); Concrete Pump; Crane (All Types, Including Boom Truck, Cherry Picker); Crane-Compact, Track or Rubber over 4,000 lbs. capacity; Cranes-Self Erecting, Stationary, Track or Truck (All Configurations); Derrick; Dragline; Dredge (Dipper, Clam or Suction); Elevating Grader or Euclid Loader; Floating Equipment (All Types); Gradall; Helicopter Crew (Operator-Hoist or Winch); Hoe (all types); Hoisting Engine on Shaft or Tunnel Work; Hydraulic Gantry (Lifting System); Industrial-Type Tractor; Jet Engine Dryer (D8 or D9) Diesel Tractor; Locomotive (Standard Gauge);

Maintenance Operator Class A; Mixer, Paving (Single or Double Drum); Mucking Machine; Multiple Scraper; Piledriving Machine (All Types); Power Shovel; Prentice Loader; Quad 9 (Double Pusher); Rail Tamper (with auto lifting & aligning device); Refrigerating Machine (Freezer Operation); Rotary Drill, on Caisson work; Rough Terrain Fork Lift with Winch/Hoist; Side-Boom; Slip-Form Paver; Tower Derrick; Tree Shredder; Trench Machine (Over 24" wide); Truck Mounted Concrete Pump; Tug Boat; Tunnel Machine and/or Mining Machine; and Wheel Excavator.

GROUP 2 - Asphalt Paver; Automatic Subgrader Machine, Self-Propelled (CMI Type); Bobcat Type and/or Skid Steer Loader with Hoe Attachment Greater than 7,000 lbs.; Boring Machine More than 48"; Bulldozer; Endloader; Hydro Milling Machine; Horizontal Directional Drill (over 50,000 ft. lbs. thrust); Kolman-type Loader (production type-Dirt); Lead Greaseman; Lighting & Traffic Signal Installation Equipment (includes all groups or classifications); Material Transfer Equipment (Shuttle Buggy) Asphalt; Pettibone-Rail Equipment; Power Grader; Power Scraper; Push Cat; Rotomill (all), Grinders & Planers of All types; Trench Machine (24" wide & under); and Vermeer type Concrete Saw.

GROUP 3 - A-Frame; Air Compressor on Tunnel Work (low pressure); Asphalt Plant Engineer; Bobcat-type and/or Skid Steer Loader with or without Attachments; Highway Drills (all types); Locomotive (narrow gauge); Material Hoist/Elevator; Mixer, Concrete (more than one bag capacity); Mixer, one bag capacity (Side Loader); Power Boiler (Over 15 lbs. Pressure) Pump Operator installing & operating Well Points; Pump (4" & over discharge); Railroad Tie Inserter/Remover; Roller, Asphalt; Rotovator (lime soil stabilizer); Switch & Tie Tampers (without lifting & aligning device); Utility Operator (Small equipment); and Welding Machines; Articulating/straight bed end dumps if assigned (minus \$4.00 per hour).

GROUP 4 - Backfiller; Ballast Re-locator; Bars, Joint & Mesh Installing Machine; Batch Plant; Boring Machine Operator (48" or less); Bull Floats; Burlap & Curing Machine; Concrete Plant (capacity 4 yd. & under); Concrete Saw (Multiple); Conveyor (Highway); Crusher; Deckhand; Farm-type Tractor with attachments (highway); Finishing Machine; Fireperson, Floating Equipment (all types); Fork Lift; Form Trencher; Hydro Hammer expect masonry; Hydro Seeder; Pavement Breaker; Plant Mixer; Post Driver; Post Hole Digger (Power Auger); Power Brush Burner; Power Form Handling Equipment; Road Widening Trencher; Roller (Brick, Grade & Macadam); Self-Propelled Power Spreader; Self-Propelled Power Subgrader; Steam Fireperson; Tractor (Pulling Sheepfoot, Roller or Grader); and Vibratory Compactor with Integral Power.

GROUP 5 - Compressor (Portable, Sewer, Heavy & Highway); Drum Fireperson (Asphalt Plant); Generator; Masonary Forklift; Inboard-Outboard Motor Boat Launch; Oil Heater (asphalt plant); Oiler/Helper; Power Driven Heater; Power Sweeper & Scrubber; Pump (under 4" discharge); Signaller; Tire Repairperson; VAC/ALLS; Cranes - Compact, track or rubber under 4,000 pound capacity; fueling and greasing; and Chainmen.

GROUP 6 - Master Mechanic & Boom from 150 to 180.

GROUP 7 - Boom from 180 and over.

 ENGI0066-023 06/01/2023

COLUMBIANA, MAHONING & TRUMBULL COUNTIES

	Rates	Fringes
POWER EQUIPMENT OPERATOR		
ASBESTOS; HAZARDOUS/TOXIC WASTE PROJECTS		
GROUP 1 - A & B.....	\$ 44.63	24.30
ASBESTOS; HAZARDOUS/TOXIC WASTE PROJECTS		
GROUP 2 - A & B.....	\$ 44.30	24.30
ASBESTOS; HAZARDOUS/TOXIC WASTE PROJECTS		
GROUP 3 - A & B.....	\$ 38.47	24.30
ASBESTOS; HAZARDOUS/TOXIC WASTE PROJECTS		
GROUP 4 - A & B.....	\$ 34.52	24.30
ASBESTOS; HAZARDOUS/TOXIC WASTE PROJECTS		
GROUP 5 - A & B.....	\$ 31.13	24.30
HAZARDOUS/TOXIC WASTE PROJECTS		
GROUP 1 - C & D.....	\$ 40.91	24.30
HAZARDOUS/TOXIC WASTE PROJECTS		
GROUP 2 - C & D.....	\$ 40.61	24.30
HAZARDOUS/TOXIC WASTE PROJECTS		
GROUP 3 - C & D.....	\$ 35.27	24.30
HAZARDOUS/TOXIC WASTE PROJECTS		
GROUP 4 - C & D.....	\$ 31.65	24.30
HAZARDOUS/TOXIC WASTE PROJECTS		
GROUP 5 - C & D.....	\$ 28.53	24.30
ALL OTHER WORK		
GROUP 1.....	\$ 37.19	24.30
ALL OTHER WORK		
GROUP 2.....	\$ 36.92	24.30
ALL OTHER WORK		
GROUP 3.....	\$ 32.06	24.30
ALL OTHER WORK		
GROUP 4.....	\$ 28.77	24.30
ALL OTHER WORK		
GROUP 5.....	\$ 25.94	24.30

GROUP 1 - Rig, Pile Driver or Caisson Type; & Rig, Pile Hydraulic Unit Attached

GROUP 2 - Asphalt Heater Planer; Backfiller with Drag Attachment; Backhoe; Backhoe with Shear attached; Backhoe-Rear Pivotal Swing; Batch Plant-Central Mix Concrete; Batch Plant, Portable concrete; Berm Builder-Automatic; Boat Derrick; Boat-Tug; Boring Machine Attached to Tractor; Bullclam; Bulldozer; C.M.I. Road Builder & Similar Type; Cable Placer & Layer; Carrier-Straddle; Carryall-Scraper or Scoop; Chicago Boom; Compactor with Blade Attached; Concrete Saw (Vermeer or similar type); Concrete Spreader Finisher; Combination, Bidwell Machine; Crane; Crane-Electric Overhead;

Crane-Rough Terrain; Crane-Side Boom; Crane-Truck;
 Crane-Tower; Derrick-Boom; Derrick-Car; Digger-Wheel (Not
 trencher or road widener); Double Nine; Drag Line; Dredge;
 Drill-Kenny or Similar Type; Easy Pour Median Barrier
 Machine (or similar type); Electromatic; Frankie Pile;
 Gradall; Grader; Gurry; Self-Propelled; Heavy Equipment
 Robotics Operator/Mechanic; Hoist-Monorail;
 Hoist-Stationary & Mobile Tractor; Hoist, 2 or 3 drum;
 Horizontal Directional Drill Operator; Jackall; Jumbo
 Machine; Kocal & Kuhlman; Land-Seagoing Vehicle; Loader,
 Elevating; Loader, Front End; Loader, Skid Steer;
 Locomotive; Mechanic/Welder; Metro Chip Harvester with
 Boom; Mucking Machine; Paver-Asphalt Finishing Machine;
 Paver-Road Concrete; Paver-Slip Form (C.M.I. or similar);
 Place Crete Machine with Boom; Post Driver (Carrier
 mounted); Power Driven Hydraulic Pump & Jack (When used in
 Slip Form or Lift Slab Construction); Pump Crete Machine;
 Regulator-Ballast; Hydraulic Power Unit not attached to Rig
 for Pile Drillings; Rigs-Drilling; Roto Mill or similar
 Full Lane (8' Wide & Over); Roto Mill or similar type
 (Under 8'); Shovel; Slip Form Curb Machine; Speedwing;
 Spikemaster; Stonecrusher; Tie Puller & Loader; Tie Tamper;
 Tractor-Double Boom; Tractor with Attachments; Truck-Boom;
 Truck-Tire; Trench Machine; Tunnel Machine (Mark 21 Java
 or similar); & Whirley (or similar type)

GROUP 3 - Asphalt Plant; Bending Machine (Pipeline or similar
 type); Boring machine, Motor Driven; Chip Harvester
 without Boom; Cleaning Machine, Pipeline Type; Coating
 Machine, Pipeline Type; Compactor; Concrete Belt Placer;
 Concrete Finisher; Concrete Planer or Asphalt; Concrete
 Spreader; Elevator; Fork Lift (Home building only); Fork
 lift & Lulls; Fork Lift Walk Behind (Hoisting over 1 buck
 high); Form Line Machine; Grease Truck operator; Grout
 Pump; Gunnite Machine; Horizontal Directional Drill
 Locator; Single Drum Hoist with or without Tower; Huck
 Bolting Machine; Hydraulic Scaffold (Hoisting building
 materials); Paving Breaker (Self-propelled or Ridden);
 Pipe Dream; Pot Fireperson (Power Agitated); Refrigeration
 Plant; Road Widener; Roller; Sasgen Derrick; Seeding
 Machine; Soil Stabilizer (Pump type); Spray Cure Machine,
 Self-Propelled; Straw Blower Machine; Sub-Grader; Tube
 Finisher or Broom C.M.I. or similar type; & Tugger Hoist

GROUP 4 - Air Curtain Destructor & Similar Type; Batch
 Plant-Job Related; Boiler Operator; Compressor; Conveyor;
 Curb Builder, self-propelled; Drill Wagon; Generator Set;
 Generator-Steam; Heater-Portable Power; Hydraulic
 Manipulator Crane; Jack-Hydraulic Power driven;
 Jack-Hydraulic (Railroad); Ladavator; Minor Machine
 Operator; Mixer-Concrete; Mulching Machine; Pin Puller;
 Power Broom; Pulverizer; Pump; Road Finishing Machine (Pull
 Type); Saw-Concrete-Self-Propelled (Highway Work); Signal
 Person; Spray Cure Machine-Motor Powered; Stump Cutter;
 Tractor; Trencher Form; Water Blaster; Steam Jenny;
 Syphon; Vibrator-Gasoline; & Welding Machine

GROUP 5 - Brakeperson; Fireperson; & Oiler

 IRON0017-002 05/01/2024

ASHTABULA (North of Route 6, starting at the Geauga County
 Line, proceeding east to State Route 45), CUYAHOGA, ERIE
 (Eastern 2/3), GEauga, HURON (East of a line drawn from the

north border through Monroeville & Willard), LAKE, LORAIN, MEDINA (North of Old Rte. #224), PORTAGE (West of a line from Middlefield to Shalersville to Deerfield), and SUMMIT (North of Old Rte. #224, including city limits of Barberton) COUNTIES

Rates Fringes

IRONWORKER

Ornamental, Reinforcing, & Structural.....\$ 36.83 29.01

IRON0017-010 05/01/2024

ASHTABULA (Eastern part from Lake Erie on the north to route #322 on the south to include Conneaut, Kingsville, Sheffield, Denmark, Dorset, Cherry Valley, Wayne, Monroe, Pierpont, Richmond, Andover & Williamsfield Townships)

Rates Fringes

IRONWORKER

Structural, including metal building erection & Reinforcing.....\$ 36.83 29.01

IRON0044-001 06/01/2025

ADAMS (Western Part), BROWN, BUTLER (Southern Part), CLERMONT, CLINTON (South of a line drawn from Blanchester to Lynchburg), HAMILTON, HIGHLAND (Excluding eastern one-fifth & portion of county inside lines drawn from Marshall to Lynchburg from the northern county line through E. Monroe to Marshall) and WARREN (South of a line drawn from Blanchester through Morrow to the west county line) COUNTIES

Rates Fringes

IRONWORKER, REINFORCING.....\$ 38.27 23.90

IRON0044-002 06/01/2025

CLINTON (South of a line drawn from Blanchester to Lynchburg), HAMILTON, HIGHLAND (Excluding eastern one-fifth & portion of county inside lines drawn from Marshall to Lynchburg from the northern county line through E. Monroe to Marshall) & WARREN (South of a line drawn from Blanchester through Morrow to the west county line)

Rates Fringes

IRONWORKER

Fence Erector.....\$ 35.88 23.90
Ornamental; Structural.....\$ 37.77 23.90

IRON0055-003 07/01/2024

CRAWFORD (Area Between lines drawn from where Hwy #598 & #30 meet through N. Liberty to the northern border & from said Hwy junction point due west to the border), DEFIANCE (S. of a line drawn from where Rte. #66 meets the northern line through Independence to the eastern county border), ERIE (Western 1/3),

FULTON, HANCOCK, HARDIN (North of a line drawn from Maysville to a point 4 miles south of the northern line on the eastern line), HENRY, HURON (West of a line drawn from the northern border through Monroeville & Willard), LUCAS, OTTAWA, PUTNAM (East of a line drawn from the northern border down through Miller City to where #696 meets the southern border), SANDUSKY, SENECA, WILLIAMS (East of a line drawn from Pioneer through Stryker to the southern border), WOOD & WYANDOT (North of Rte. #30)

	Rates	Fringes
IRONWORKER		
Fence Erector.....	\$ 26.40	24.62
Flat Road Mesh.....	\$ 29.77	21.30
Tunnels & Caissons Under Pressure.....	\$ 29.77	21.30
All Other Work.....	\$ 35.50	29.20

IRON0147-002 06/01/2025		

ALLEN (Northern half), DEFIANCE (Northern part, excluding south of a line drawn from where Rte. #66 meets the northern line through Independence to the eastern county border), MERCER (Northern half), PAULDING, PUTNAM (Western part, excluding east of a line drawn from the northern border down through Miller City to where #696 meets the southern border), VAN WERT, and WILLIAMS (Western part, excluding east of a line drawn from Pioneer through Stryker to the southern border) COUNTIES

	Rates	Fringes
IRONWORKER.....	\$ 38.00	26.39

IRON0172-002 06/01/2025		

CHAMPAIGN (Eastern one-third), CLARK (Eastern one-fourth), COSHOCTON (West of a line beginning at the northwestern county line going through Walhonding & Tunnel Hill to the southern county line), CRAWFORD (South of Rte. #30), DELAWARE, FAIRFIELD, FAYETTE, FRANKLIN, HARDIN (Excluding a line drawn from Roundhead to Maysville), HIGHLAND (Eastern one-fifth), HOCKING, JACKSON (Northern half), KNOX, LICKING, LOGAN (Eastern one-third), MADISON, MARION, MORROW, MUSKINGUM (West of a line starting at Adams Mill going to Adamsville & going from Adamsville through Blue Rock to the southern border), PERRY, PICKAWAY, PIKE (Northern half), ROSS, UNION, VINTON and WYANDOT (South of Rte. #30) COUNTIES

	Rates	Fringes
IRONWORKER.....	\$ 40.87	23.15

IRON0207-004 06/01/2025		

ASHTABULA (Southern part starting at the Geauga County line), COLUMBIANA (E. of a line from Damascus to Highlandtown), MAHONING (N. of Old Route #224), PORTAGE (E. of a line from Middlefield to Shalersville to Deerfield) & TRUMBULL

Rates Fringes

IRONWORKER

Layout; Sheeter.....	\$ 37.26	28.16
Ornamental; Reinforcing; Structural.....	\$ 36.26	28.16

IRON0290-002 06/01/2025

ALLEN (Southern half), AUGLAIZE, BUTLER (North of a line drawn from east to the west county line going through Oxford, Darrtown & Woodsdale), CHAMPAIGN (Excluding east of a line drawn from Catawla to the point where #68 intersects the northern county line), CLARK (Western two-thirds), CLINTON (Excluding south of a line drawn from Blanchester to Lynchburg), DARKE, GREENE, HIGHLAND (Inside lines drawn from Marshall to Lynchburg & from the northern county line through East Monroe to Marshall), LOGAN (West of a line drawn from West Liberty to where the northern county line meets the western county line of Hardin), MERCER (Southern half), MIAMI, MONTGOMERY, PREBLE, SHELBY & WARREN (Excluding south of a line drawn from Blanchester through Morrow to the western county line) COUNTIES

Rates Fringes

IRONWORKER.....	\$ 37.39	25.35
-----------------	----------	-------

IRON0549-003 12/01/2022

BELMONT, GUERNSEY, HARRISON, JEFFERSON, MONROE & MUSKINGUM (Excluding portion west of a line starting at Adams Mill going to Adamsville and going from Adamsville through Blue Rock to the south border)

Rates Fringes

IRONWORKER.....	\$ 35.19	25.66
-----------------	----------	-------

IRON0550-004 05/01/2024

ASHLAND, CARROLL, COLUMBIANA (W. of a line from Damascus to Highlandtown), COSHOCTON (E. of a line beginning at NW Co. line going through Walhonding & Tunnel Hill to the South Co. line), HOLMES, HURON (S. of Old Rte. #224), MAHONING (S. of Old Rte. #224), MEDINA (S. of Old Rte. #224), PORTAGE (S. of Old Rte. #224), RICHLAND, STARK, SUMMIT (S. of Old Rte. #224, Excluding city limits of Barberton), TUSCARAWAS, & WAYNE

Rates Fringes

Ironworkers:Structural, Ornamental and Reinforcing.....	\$ 34.70	22.88
--	----------	-------

IRON0769-004 06/01/2025

ADAMS (Eastern Half), GALLIA, JACKSON (Southern Half), LAWRENCE & SCIOTO

Rates Fringes

IRONWORKER.....	\$ 39.70	29.59
-----------------	----------	-------

 IRON0787-003 06/01/2025

ATHENS, MEIGS, MORGAN, NOBLE, and WASHINGTON COUNTIES

	Rates	Fringes
IRONWORKER.....	\$ 36.10	24.65

 LAB00265-008 05/01/2024

	Rates	Fringes
LABORER		
ASHTABULA, ERIE, HURON, LORAIN, LUCAS, MAHONING, MEDINA, OTTAWA, PORTAGE, SANDUSKY, STARK, SUMMIT, TRUMBULL & WOOD COUNTIES		
GROUP 1.....	\$ 35.95	14.45
GROUP 2.....	\$ 36.12	14.45
GROUP 3.....	\$ 36.45	14.45
GROUP 4.....	\$ 36.90	14.45
CUYAHOGA AND GEAUGA COUNTIES ONLY: SEWAGE PLANTS, WASTE PLANTS, WATER TREATMENT FACILITIES, PUMPING STATIONS, & ETHANOL PLANTS		
CONSTRUCTION.....	\$ 38.56	14.45
CUYAHOGA, GEAUGA & LAKE COUNTIES		
GROUP 1.....	\$ 37.18	14.45
GROUP 2.....	\$ 37.35	14.45
GROUP 3.....	\$ 37.68	14.45
GROUP 4.....	\$ 38.13	14.45
REMAINING COUNTIES OF OHIO		
GROUP 1.....	\$ 35.52	14.45
GROUP 2.....	\$ 35.69	14.45
GROUP 3.....	\$ 36.02	14.45
GROUP 4.....	\$ 36.47	14.45

LABORER CLASSIFICATIONS

GROUP 1 - Asphalt Laborer; Carpenter Tender; Concrete Curing Applicator; Dump Man (Batch Truck); Guardrail and Fence Installer; Joint Setter; Laborer (Construction); Landscape Laborer; Mesh Handlers & Placer; Right-of-way Laborer; Riprap Laborer & Grouter; Scaffold Erector; Seal Coating; Surface Treatment or Road Mix Laborer; Sign Installer; Slurry Seal; Utility Man; Bridge Man; Handyman; Waterproofing Laborer; Flagperson; Hazardous Waste (level D); Diver Tender; Zone Person & Traffic Control

GROUP 2 - Asphalt Raker; Concrete Puddler; Kettle Man Pipeline); Machine Driven Tools (Gas, Electric, Air); Mason Tender; Brick Paver; Mortar Mixer; Power Buggy or Power Wheelbarrow; Paint Striper; Sheeting & Shoring Man; Surface Grinder Man; Plastic Fusing Machine Operator; Pug Mill Operator; & Vacuum Devices (wet or dry); Rodding Machine Operator; Diver; Screwman or Paver; Screed Person; Water Blast, Hand Held Wand; Pumps 4" & Under (Gas, Air or Electric) & Hazardous Waste (level C); Air Track and Wagon Drill; Bottom Person; Cofferdam (below 25 ft. deep); Concrete Saw Person; Cutting with Burning Torch; Form

Setter; Hand Spiker (Railroad); Pipelayer; Tunnel Laborer (without air) & Caisson; Underground Person (working in Sewer and Waterline, Cleaning, Repairing & Reconditioning); Sandblaster Nozzle Person; & Hazardous Waste (level B)

GROUP 3 - Blaster; Mucker; Powder Person; Top Lander; Wrencher (Mechanical Joints & Utility Pipeline); Yarner; Hazardous Waste (level A); Concrete Specialist; Concrete Crew in Tunnels (With Air-pressurized - \$1.00 premium); Curb Setter & Cutter; Grade Checker; Utility Pipeline Tapper; Waterline; and Caulker

GROUP 4 - Miner (With Air-pressurized - \$1.00 premium); & Gunite Nozzle Person

TUNNEL LABORER WITH AIR-PRESSURIZED ADD \$1.00 TO BASE RATE

SIGNAL PERSON WILL RECEIVE THE RATE EQUAL TO THE RATE PAID THE LABORER CLASSIFICATION FOR WHICH HE OR SHE IS SIGNALING.

PAIN0006-002 05/01/2023

ASHTABULA, CUYAHOGA, GEAUGA, LAKE, LORAIN, PORTAGE (N. of the East-West Turnpike) & SUMMIT (N. of the East-West Turnpike)

Rates Fringes

PAINTER

COMMERCIAL NEW WORK;

REMODELING; & RENOVATIONS

GROUP 1.....	\$ 30.75	18.95
GROUP 2.....	\$ 31.15	18.95
GROUP 3.....	\$ 31.45	18.95
GROUP 4.....	\$ 37.01	18.95

COMMERCIAL REPAINT

GROUP 1.....	\$ 29.25	18.95
GROUP 2.....	\$ 29.65	18.95
GROUP 3.....	\$ 29.95	18.95

PAINTER CLASSIFICATIONS - COMMERCIAL NEW WORK; REMODELING; & RENOVATIONS

GROUP 1 - Brush; & Roller

GROUP 2 - Sandblasting & Buffing

GROUP 3 - Spray Painting; Closed Steel Above 55 feet; Bridges & Open Structural Steel; Tanks - Water Towers; Bridge Painters; Bridge Riggers; Containment Builders

GROUP 4 - Bridge Blaster

PAINTER CLASSIFICATIONS - COMMERCIAL REPAINT

GROUP 1 - Brush; & Roller

GROUP 2 - Sandblasting & Buffing

GROUP 3 - Spray Painting

PAIN0007-002 07/01/2025

FULTON, HENRY, LUCAS, OTTAWA (Excluding Allen, Bay, Bono, Catawba Island, Clay Center, Curtice, Danbury, Eagle Beach, Elliston, Elmore, Erie, Fishback, Gem Beach & Genova) & WOOD

Rates Fringes

PAINTER

NEW COMMERCIAL WORK

GROUP 1.....	\$ 33.66	23.88
GROUP 2.....	\$ 34.66	23.88
GROUP 3.....	\$ 34.66	23.88
GROUP 4.....	\$ 34.66	23.88
GROUP 5.....	\$ 34.66	23.88
GROUP 6.....	\$ 34.66	23.88
GROUP 7.....	\$ 34.66	23.88
GROUP 8.....	\$ 34.66	23.88
GROUP 9.....	\$ 34.66	23.88

REPAINT IS 90% OF JR

PAINTER CLASSIFICATIONS

GROUP 1 - Brush; Spray & Sandblasting Pot Tender

GROUP 2 - Refineries & Refinery Tanks; Surfaces 30 ft. or over where material is applied to or labor performed on above ground level (exterior), floor level (interior)

GROUP 3 - Swing Stage & Chair

GROUP 4 - Lead Abatement

GROUP 5 - All Methods of Spray

GROUP 6 - Solvent-Based Catalized Epoxy Materials of 2 or More Component Materials, to include Solvent-Based Conversion Varnish (excluding water based)

GROUP 7 - Spray Solvent Based Material; Sand & Abrasive Blasting

GROUP 8 - Towers; Tanks; Bridges; Stacks Over 30 Feet

GROUP 9 - Epoxy Spray (excluding water based)

PAIN0012-008 05/01/2019

BUTLER COUNTY

Rates Fringes

PAINTER

GROUP 1.....	\$ 21.95	10.20
GROUP 2.....	\$ 25.30	10.20
GROUP 3.....	\$ 25.80	10.20
GROUP 4.....	\$ 26.05	10.20
GROUP 5.....	\$ 26.30	10.20

PAINTER CLASSIFICATIONS

GROUP 1: Bridge Equipment Tender; Bridge/Containment Builder

GROUP 2: Brush & Roller

GROUP 3: Spray

GROUP 4: Sandblasting; & Waterblasting

GROUP 5: Elevated Tanks; Steeplejack Work; Bridge; & Lead Abatement

PAIN0012-010 05/01/2019

BROWN, CLERMONT, CLINTON, HAMILTON & WARREN

	Rates	Fringes
PAINTER		
HEAVY & HIGHWAY BRIDGES- GUARDRAILS-LIGHTPOLES- STRIPING		
Bridge Equipment Tender and Containment Builder....	\$ 21.95	10.20
Bridges when highest point of clearance is 60 feet or more; & Lead Abatement Projects.....		
Brush & Roller.....	\$ 26.30	10.20
Sandblasting & Hopper Tender; Water Blasting.....	\$ 25.30	10.20
Spray.....	\$ 26.05	10.20
	\$ 25.80	10.20

PAIN0093-001 12/01/2024

ATHENS, GUERNSEY, HOCKING, MONROE, MORGAN, NOBLE and WASHINGTON COUNTIES

	Rates	Fringes
PAINTER		
Bridges; Locks; Dams; Tension Towers; & Energized Substations.....		
Power Generating Facilities..	\$ 36.44	24.46
	\$ 33.29	24.46

PAIN0249-002 05/01/2025

CLARK, DARKE, GREENE, MIAMI, MONTGOMERY & PREBLE

	Rates	Fringes
PAINTER		
GROUP 1 - Brush & Roller....	\$ 29.15	13.97
GROUP 2 - Swing, Scaffold Bridges; Structural Steel; Open Acid Tank; High Tension Electrical Equipment; & Hot Pipes.....		
GROUP 3 - Spray; Sandblast; Steamclean; Lead Abatement.....	\$ 33.09	13.97
GROUP 4 - Steeplejack Work..	\$ 29.90	13.97
GROUP 5 - Coal Tar.....	\$ 30.10	13.97
GROUP 6 - Bridge Equipment Tender & or Containment	\$ 30.65	13.97

Builder.....	\$ 37.86	13.97
GROUP 7 - Tanks, Stacks & Towers.....	\$ 33.86	13.97
GROUP 8 - Bridge Blaster, Rigger.....	\$ 40.86	13.97

PAIN0356-002 09/01/2009

KNOX, LICKING, MUSKINGUM, and PERRY

Rates Fringes

PAINTER

Bridge Equipment Tenders and Containment Builders....	\$ 27.93	7.25
Bridges; Blasters; and Riggers.....	\$ 34.60	7.25
Brush and Roller.....	\$ 20.93	7.25
Sandblasting; Steam Cleaning; Waterblasting; and Hazardous Work.....	\$ 25.82	7.25
Spray.....	\$ 21.40	7.25
Structural Steel and Swing Stage.....	\$ 25.42	7.25
Tanks; Stacks; and Towers...	\$ 28.63	7.25

PAIN0438-002 12/01/2023

BELMONT, HARRISON and JEFFERSON COUNTIES

Rates Fringes

PAINTER

Bridges, Locks, Dams, Tension Towers & Energized Substations.....	\$ 36.09	19.49
Power Generating Facilities.	\$ 32.94	19.49

PAIN0476-001 06/01/2025

COLUMBIANA, MAHONING, and TRUMBULL COUNITIES

Rates Fringes

PAINTER

GROUP 1.....	\$ 30.64	18.36
GROUP 2.....	\$ 40.27	18.36
GROUP 3.....	\$ 40.27	18.36
GROUP 4.....	\$ 31.14	18.36
GROUP 5.....	\$ 31.29	18.36
GROUP 6.....	\$ 35.27	18.36
GROUP 7.....	\$ 32.64	18.36

PAINTER CLASSIFICATIONS:

GROUP 1: Painters, Brush & Roller

GROUP 2: Bridges

GROUP 3: Structural Steel

GROUP 4: Spray, Except Bar Joist/Deck

GROUP 5: Epoxy/Mastic; Spray- Bar Joist/Deck; Working Above
50 Feet; and Swingstages

GROUP 6: Tanks; Sandblasting

GROUP 7: Towers; Stacks

PAIN0555-002 01/01/2025

ADAMS, HIGHLAND, JACKSON, PIKE & SCIOTO

	Rates	Fringes
PAINTER		
GROUP 1.....	\$ 33.32	21.54
GROUP 2.....	\$ 35.02	21.54
GROUP 3.....	\$ 36.72	21.54
GROUP 4.....	\$ 40.03	21.54

PAINTER CLASSIFICATIONS

GROUP 1 - Containment Builder

GROUP 2 - Brush; Roller; Power Tools, Under 40 feet

GROUP 3 - Sand Blasting; Spray; Steam Cleaning; Pressure Washing; Epoxy & Two Component Materials; Lead Abatement; Hazardous Waste; Toxic Materials; Bulk & Storage Tanks of 25,000 Gallon Capacity or More; Elevated Tanks

GROUP 4 - Stacks; Bridges

PAIN0639-001 05/01/2011

	Rates	Fringes
Sign Painter & Erector.....	\$ 20.61	3.50+a+b+c

FOOTNOTES: a. 7 Paid Holidays: New Year's Day; Memorial Day; July 4th; Labor Day; Thanksgiving Day; Christmas Day & 1 Floating Day
 b. Vacation Pay: After 1 year's service - 5 days' paid vacation; After 2, but less than 10 years' service - 10 days' paid vacation; After 10, but less than 20 years' service - 15 days' paid vacation; After 20 years' service - 20 days' paid vacation
 c. Funeral leave up to 3 days maximum paid leave for death of mother, father, brother, sister, spouse, child, mother-in-law, father-in-law, grandparent and inlaw provided employee attends funeral

PAIN0788-002 06/01/2024

ASHLAND, CRAWFORD, ERIE, HANCOCK, HURON, MARION, MORROW, OTTAWA (Allen, Bay, Bono, Catawba Island, Clay Center, Curtice, Danbury, Eagle Beach, Elliston, Elmore, Erie, Fishback, Gem Beach & Genoa), RICHLAND, SANDUSKY, SENECA & WYANDOT

	Rates	Fringes
PAINTER		
Brush & Roller.....	\$ 29.13	17.52
Structural Steel.....	\$ 30.73	17.52

WINTER REPAINT: Between December 1 to March 31 - 90%JR

\$.50 PER HOUR SHALL BE ADDED TO THE RATE OF PAY FOR THE CLASSIFICATION OF WORK:

While working swingstage, boatswain chair, needle beam and horizontal cable. While operating sprayguns, sandblasting, cobblasting and high pressure waterblasting (4000psi).

\$1.00 PER HOUR SHALL BE ADDED TO THE RATE OF PAY FOR THE CLASSIFICATION OF WORK:

For the application of catalized epoxy, including latex epoxy that is deemed hazardous, lead abatement, or for work or material where special precautions beyond normal work duties must be taken. For working on stacks, tanks, and towers over 40 feet in height.

PAIN0813-005 12/01/2008

GALLIA, LAWRENCE, MEIGS & VINTON

	Rates	Fringes
PAINTER		
Base Rate.....	\$ 24.83	10.00
Bridges, Locks, Dams & Tension Towers.....	\$ 27.83	10.00

PAIN0841-001 07/01/2025

MEDINA, PORTAGE (South of and including Ohio Turnpike), and SUMMIT (South of and including Ohio Turnpike) COUNTIES

	Rates	Fringes
Painters:		
GROUP 1.....	\$ 31.93	18.15
GROUP 2.....	\$ 32.58	18.15
GROUP 3.....	\$ 32.68	18.15
GROUP 4.....	\$ 32.78	18.15
GROUP 5.....	\$ 33.18	18.15
GROUP 6.....	\$ 38.60	18.15
GROUP 7.....	\$ 33.18	18.15

PAINTER CLASSIFICATIONS:

GROUP 1 - Brush, Roller & Paperhanger

GROUP 2 - Epoxy Application

GROUP 3 - Swing Scaffold, Bosum Chair, & Window Jack

GROUP 4 - Spray Gun Operator of Any & All Coatings

GROUP 5 - Sandblast, Painting of Standpipes, etc. from Scaffolds, Bridge Work and/or Open Structural Steel, Standpipes and/or Water Towers

GROUP 6 - Public & Commerce Transportation, Steel or Galvanized, Bridges, Tunnels & Related Support Items (concrete)

GROUP 7 - Synthetic Exterior, Drywall Finisher and/or Taper,
Drywall Finisher and Follow-up Man Using Automatic Tools

PAIN0841-002 07/01/2025

CARROLL, COSHOCTON, HOLMES, STARK, TUSCARAWAS & WAYNE

	Rates	Fringes
PAINTER		
Bridges; Towers, Poles & Stacks; Sandblasting Steel; Structural Steel & Metalizing.....	\$ 33.18	18.15
Brush & Roller.....	\$ 31.93	18.15
Spray; Tank Interior & Exterior.....	\$ 32.78	18.15

PAIN1020-002 07/01/2025

ALLEN, AUGLAIZE, CHAMPAIGN, DEFIANCE, HARDIN, LOGAN, MERCER,
PAULDING, PUTNAM, SHELBY, VAN WERT, and WILLIAMS COUNTIES

	Rates	Fringes
PAINTER		
Brush & Roller.....	\$ 27.59	18.54
Drywall Finishing & Taping..	\$ 28.34	18.54
Lead Abatement.....	\$ 29.34	18.54
Spray, Sandblasting Pressure Cleaning, & Refinery.....	\$ 28.34	18.54
Swing Stage, Chair, Spiders, & Cherry Pickers...	\$ 27.84	18.54
Wallcoverings.....	\$ 28.34	18.54

All surfaces 40 ft. or over where material is applied to or
labor performed on, above ground level (exterior), floor
level (interior) - \$.50 premium

Applying Coal Tar Products - \$1.00 premium

PAIN1275-002 05/01/2025

DELAWARE, FAIRFIELD, FAYETTE, FRANKLIN, MADISON, PICKAWAY, ROSS
& UNION

	Rates	Fringes
PAINTER		
Bridges.....	\$ 37.26	15.16
Brush; Roller.....	\$ 30.20	15.16
Sandblasting; Steamcleaning; Waterblasting (3500 PSI or Over)& Hazardous Work.....	\$ 32.35	15.16
Spray.....	\$ 32.15	15.16
Stacks; Tanks; & Towers.....	\$ 34.46	15.16
Structural Steel & Swing Stage.....	\$ 30.50	15.16

PLAS0109-001 06/01/2025

MEDINA, PORTAGE, STARK, and SUMMIT COUNTIES

	Rates	Fringes
PLASTERER.....	\$ 33.00	23.83

PLAS0109-003 06/01/2025

CARROLL, HOLMES, TUSCARAWAS, and WAYNE COUNTIES

	Rates	Fringes
PLASTERER.....	\$ 33.00	23.83

PLAS0132-002 07/01/2025

BROWN, BUTLER, CLERMONT, HAMILTON, HIGHLAND, WARREN COUNTIES

	Rates	Fringes
PLASTERER.....	\$ 31.35	17.65

PLAS0404-002 05/01/2018

ASHTABULA, CUYAHOGA, GEAUGA, AND LAKE COUNTIES

	Rates	Fringes
PLASTERER.....	\$ 29.63	17.11

PLAS0404-003 05/01/2018

LORAIN COUNTY

	Rates	Fringes
PLASTERER.....	\$ 28.86	17.11

PLAS0526-022 05/01/2018

COLUMBIANA, MAHONING, and TRUMBULL COUNTIES

	Rates	Fringes
PLASTERER.....	\$ 28.86	17.11

PLAS0526-023 05/01/2018

BELMONT, HARRISON, and JEFFERSON COUNTIES

	Rates	Fringes
PLASTERER.....	\$ 28.21	17.11

PLAS0886-001 07/01/2025

FULTON, HANCOCK, HENRY, LUCAS, PUTNAM, and WOOD COUNTIES

	Rates	Fringes
PLASTERER.....	\$ 36.65	25.60

PLAS0886-003 07/01/2025

DEFIANCE, ERIE, HURON, OTTAWA, PAULDING, SANDUSKY, and SENECA

	Rates	Fringes
PLASTERER.....	\$ 36.65	25.60

PLAS0886-004 07/01/2025

ALLEN, AUGLAIZE, HARDIN, LOGAN, MERCER, and VAN WERT

	Rates	Fringes
PLASTERER.....	\$ 35.29	23.07

PLUM0042-002 07/01/2025

ASHLAND, CRAWFORD, ERIE, HURON, KNOX, LORAIN, MORROW, RICHLAND & WYANDOT

	Rates	Fringes
Plumber, Pipefitter, Steamfitter.....	\$ 43.02	26.45

PLUM0050-002 06/30/2025

DEFIANCE, FULTON, HANCOCK, HENRY, LUCAS, OTTAWA, PAULDING, PUTNAM, SANDUSKY, SENECA, WILLIAMS & WOOD

	Rates	Fringes
Plumber, Pipefitter, Steamfitter.....	\$ 51.00	32.56

PLUM0055-003 05/05/2025

ASHTABULA, CUYAHOGA, GEAUGA, LAKE, MEDINA (N. of Rte. #18 & Smith Road) & SUMMIT (N. of Rte. #303, including the corporate limits of the city of Hudson)

	Rates	Fringes
PLUMBER.....	\$ 44.86	30.03

PLUM0083-001 07/01/2023

BELMONT & MONROE (North of Rte. #78)

	Rates	Fringes
Plumber and Steamfitter.....	\$ 35.94	37.35

PLUM0094-002 05/01/2025

CARROLL (Northen Half), STARK, and WAYNE COUNTIES

	Rates	Fringes
PLUMBER/PIPEFITTER.....	\$ 47.48	27.14

PLUM0120-002 05/01/2025

ASHTABULA, CUYAHOGA, GEAUGA, LAKE, LORAIN (the C.E.I. Power House in Avon Lake), MEDINA (N. of Rte. #18) & SUMMIT (N. of #303)

	Rates	Fringes
PIPEFITTER.....	\$ 49.17	28.55

PLUM0162-002 06/01/2024

CHAMPAIGN, CLARK, CLINTON, DARKE, FAYETTE, GREENE, MIAMI, MONTGOMERY & PREBLE

	Rates	Fringes
Plumber, Pipefitter, Steamfitter.....	\$ 43.05	27.18

PLUM0168-002 06/01/2025

MEIGS, MONROE (South of Rte. #78), MORGAN (South of Rte. #78) & WASHINGTON

	Rates	Fringes
PLUMBER/PIPEFITTER.....	\$ 40.92	37.20

PLUM0189-002 06/01/2024

DELAWARE, FAIRFIELD, FRANKLIN, HOCKING, LICKING, MADISON, MARION, PERRY, PICKAWAY, ROSS & UNION

	Rates	Fringes
Plumber, Pipefitter, Steamfitter.....	\$ 43.25	26.94

PLUM0219-002 06/01/2025

MEDINA (Rte. #18 from eastern edge of Medina Co., west to eastern corporate limits of the city of Medina, & on the county road from the west corporate limits of Medina running due west to and through community of Risley to the western edge of Medina County - All territory south of this line), PORTAGE, and SUMMIT (S. of Rte. #303) COUNTIES

	Rates	Fringes
Plumber and Steamfitter.....	\$ 46.87	28.39

PLUM0392-002 06/01/2025

BROWN, BUTLER, CLERMONT, HAMILTON & WARREN

	Rates	Fringes
PLUMBER/PIPEFITTER.....	\$ 43.30	27.40

PLUM0396-001 06/01/2025

COLUMBIANA (Excluding Washington & Yellow Creek Townships & Liverpool Twp. - Secs. 35 & 36 - West of County Road #427), MAHONING and TRUMBULL COUNTIES

	Rates	Fringes
PLUMBER/PIPEFITTER.....	\$ 40.55	29.25

PLUM0495-002 06/01/2025

CARROLL (Rose, Monroe, Union, Lee, Orange, Perry & Loudon Townships), COLUMBIANA (Washington & Yellow Creek Townships & Liverpool Township, Secs. 35 & 36, West of County Rd. #427), COSHOCTON, GUERNSEY, HARRISON, HOLMES, JEFFERSON, MORGAN (South to State Rte. #78 & from McConnelsville west on State Rte. #37 to the Perry County line), MUSKINGUM, NOBLE, and TUSCARAWAS COUNTIES

	Rates	Fringes
Plumber, Pipefitter, Steamfitter.....	\$ 39.32	37.60

PLUM0577-002 06/01/2025

ADAMS, ATHENS, GALLIA, HIGHLAND, JACKSON, LAWRENCE, PIKE, SCIOTO & VINTON

	Rates	Fringes
Plumber, Pipefitter, Steamfitter.....	\$ 42.65	28.56

PLUM0776-002 07/01/2025

ALLEN, AUGLAIZE, HARDIN, LOGAN, MERCER, SHELBY and VAN WERT COUNTIES

	Rates	Fringes
Plumber, Pipefitter, Steamfitter.....	\$ 42.76	30.81

TEAM0377-003 05/01/2025

STATEWIDE, EXCEPT CUYAHOGA, GEAUGA & LAKE

	Rates	Fringes
TRUCK DRIVER		
GROUP 1.....	\$ 34.26	18.85
GROUP 2.....	\$ 35.26	18.85

TRUCK DRIVER CLASSIFICATIONS

GROUP 1 - Asphalt Distributor; Batch; 4- Wheel Service; 4-Wheel Dump; Oil Distributor & Tandem

GROUP 2 - Tractor-Trailer Combination: Fuel; Pole Trailer;

Ready Mix; Semi-Tractor; & Asphalt Oil Spraybar Man When Operated From Cab; 5 Axles & Over; Belly Dump; End Dump; Articulated Dump; Heavy Duty Equipment; Low Boy; & Truck Mechanic

TEAM0436-002 05/01/2025

CUYAHOGA, GEAUGA & LAKE

	Rates	Fringes
TRUCK DRIVER		
GROUP 1.....	\$ 34.92	19.30
GROUP 2.....	\$ 35.73	19.30

GROUP 1: Straight & Dump, Straight Fuel

GROUP 2: Semi Fuel, Semi Tractor, Euclids, Darts, Tank, Asphalt Spreaders, Low Boys, Carry-All, Tourna-Rockers, Hi-Lifts, Extra Long Trailers, Semi-Pole Trailers, Double Hook-Up Tractor Trailers including Team Track & Railroad Siding, Semi-Tractor & Tri-Axle Trailer, Tandem Tractor & Tandem Trailer, Tag Along Trailer, Expandable Trailer or Towing Requiring Road Permits, Ready-Mix (Agitator or Non-Agitator), Bulk Concrete Driver, Dry Batch Truck, Articulated End Dump

WELDERS - Receive rate prescribed for craft performing operation to which welding is incidental.

=====
Note: Executive Order (EO) 13706, Establishing Paid Sick Leave for Federal Contractors applies to all contracts subject to the Davis-Bacon Act for which the contract is awarded (and any solicitation was issued) on or after January 1, 2017. If this contract is covered by the EO, the contractor must provide employees with 1 hour of paid sick leave for every 30 hours they work, up to 56 hours of paid sick leave each year. Employees must be permitted to use paid sick leave for their own illness, injury or other health-related needs, including preventive care; to assist a family member (or person who is like family to the employee) who is ill, injured, or has other health-related needs, including preventive care; or for reasons resulting from, or to assist a family member (or person who is like family to the employee) who is a victim of, domestic violence, sexual assault, or stalking. Additional information on contractor requirements and worker protections under the EO is available at <https://www.dol.gov/agencies/whd/government-contracts>.

Note: Executive Order 13658 generally applies to contracts subject to the Davis-Bacon Act that were awarded on or between January 1, 2015 and January 29, 2022, and that have not been renewed or extended on or after January 30, 2022. Executive Order 13658 does not apply to contracts subject only to the Davis-Bacon Related Acts regardless of when they were awarded. If a contract is subject to Executive Order 13658, the contractor must pay all covered workers at least \$13.30 per hour (or the applicable wage rate listed on this wage determination, if it is higher) for all hours spent performing on the contract in 2025. The applicable Executive Order

minimum wage rate will be adjusted annually. Additional information on contractor requirements and worker protections under Executive Order 13658 is available at www.dol.gov/whd/govcontracts.

Unlisted classifications needed for work not included within the scope of the classifications listed may be added after award only as provided in the labor standards contract clauses (29CFR 5.5 (a) (1) (iii)).

The body of each wage determination lists the classifications and wage rates that have been found to be prevailing for the type(s) of construction and geographic area covered by the wage determination. The classifications are listed in alphabetical order under rate identifiers indicating whether the particular rate is a union rate (current union negotiated rate), a survey rate, a weighted union average rate, a state adopted rate, or a supplemental classification rate.

Union Rate Identifiers

A four-letter identifier beginning with characters other than ""SU"", ""UAVG"", ?SA?, or ?SC? denotes that a union rate was prevailing for that classification in the survey. Example: PLUM0198-005 07/01/2024. PLUM is an identifier of the union whose collectively bargained rate prevailed in the survey for this classification, which in this example would be Plumbers. 0198 indicates the local union number or district council number where applicable, i.e., Plumbers Local 0198. The next number, 005 in the example, is an internal number used in processing the wage determination. The date, 07/01/2024 in the example, is the effective date of the most current negotiated rate.

Union prevailing wage rates are updated to reflect all changes over time that are reported to WHD in the rates in the collective bargaining agreement (CBA) governing the classification.

Union Average Rate Identifiers

The UAVG identifier indicates that no single rate prevailed for those classifications, but that 100% of the data reported for the classifications reflected union rates. EXAMPLE: UAVG-OH-0010 01/01/2024. UAVG indicates that the rate is a weighted union average rate. OH indicates the State of Ohio. The next number, 0010 in the example, is an internal number used in producing the wage determination. The date, 01/01/2024 in the example, indicates the date the wage determination was updated to reflect the most current union average rate.

A UAVG rate will be updated once a year, usually in January, to reflect a weighted average of the current rates in the collective bargaining agreements on which the rate is based.

Survey Rate Identifiers

The ""SU"" identifier indicates that either a single non-union rate prevailed (as defined in 29 CFR 1.2) for this classification in the survey or that the rate was derived by computing a weighted average rate based on all the rates reported in the survey for that classification. As a weighted

average rate includes all rates reported in the survey, it may include both union and non-union rates. Example: SUFL2022-007 6/27/2024. SU indicates the rate is a single non-union prevailing rate or a weighted average of survey data for that classification. FL indicates the State of Florida. 2022 is the year of the survey on which these classifications and rates are based. The next number, 007 in the example, is an internal number used in producing the wage determination. The date, 6/27/2024 in the example, indicates the survey completion date for the classifications and rates under that identifier.

?SU? wage rates typically remain in effect until a new survey is conducted. However, the Wage and Hour Division (WHD) has the discretion to update such rates under 29 CFR 1.6(c)(1).

State Adopted Rate Identifiers

The ""SA"" identifier indicates that the classifications and prevailing wage rates set by a state (or local) government were adopted under 29 C.F.R 1.3(g)-(h). Example: SAME2023-007 01/03/2024. SA reflects that the rates are state adopted. ME refers to the State of Maine. 2023 is the year during which the state completed the survey on which the listed classifications and rates are based. The next number, 007 in the example, is an internal number used in producing the wage determination. The date, 01/03/2024 in the example, reflects the date on which the classifications and rates under the ?SA? identifier took effect under state law in the state from which the rates were adopted.

WAGE DETERMINATION APPEALS PROCESS

1) Has there been an initial decision in the matter? This can be:

- a) a survey underlying a wage determination
- b) an existing published wage determination
- c) an initial WHD letter setting forth a position on a wage determination matter
- d) an initial conformance (additional classification and rate) determination

On survey related matters, initial contact, including requests for summaries of surveys, should be directed to the WHD Branch of Wage Surveys. Requests can be submitted via email to davisbaconinfo@dol.gov or by mail to:

Branch of Wage Surveys
 Wage and Hour Division
 U.S. Department of Labor
 200 Constitution Avenue, N.W.
 Washington, DC 20210

Regarding any other wage determination matter such as conformance decisions, requests for initial decisions should be directed to the WHD Branch of Construction Wage Determinations. Requests can be submitted via email to BCWD-Office@dol.gov or by mail to:

Branch of Construction Wage Determinations
 Wage and Hour Division
 U.S. Department of Labor
 200 Constitution Avenue, N.W.

Washington, DC 20210

2) If an initial decision has been issued, then any interested party (those affected by the action) that disagrees with the decision can request review and reconsideration from the Wage and Hour Administrator (See 29 CFR Part 1.8 and 29 CFR Part 7). Requests for review and reconsideration can be submitted via email to dba.reconsideration@dol.gov or by mail to:

Wage and Hour Administrator
U.S. Department of Labor
200 Constitution Avenue, N.W.
Washington, DC 20210

The request should be accompanied by a full statement of the interested party's position and any information (wage payment data, project description, area practice material, etc.) that the requestor considers relevant to the issue.

3) If the decision of the Administrator is not favorable, an interested party may appeal directly to the Administrative Review Board (formerly the Wage Appeals Board). Write to:

Administrative Review Board
U.S. Department of Labor
200 Constitution Avenue, N.W.
Washington, DC 20210.

=====

END OF GENERAL DECISION

..