

# SLAWSR00775\*\*C

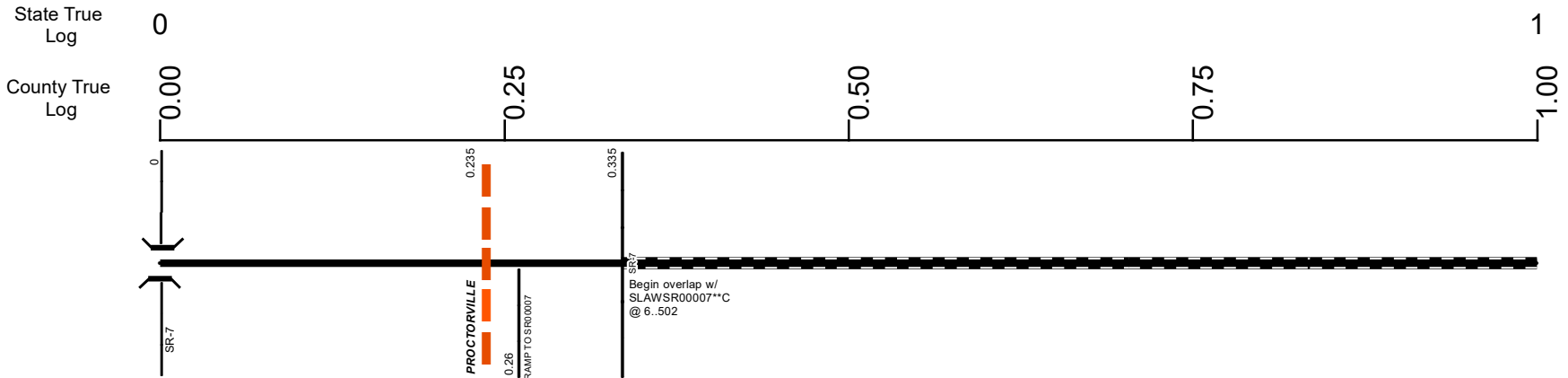

### Surface Type & Width (Left / Right)

D 30'	G 30'
0 - 0.235	0.235 - 0.335

### Shoulder Type & Width (Left / Right)

1 (0'/0')
0 - 0.335

### Through Lanes

2
0 - 0.335

### Street Name

SR 775
0 - 0.335

- Non-divided Highway
- Divided Highway
- Secondary Segment
- Corporation
- Bridge (on route)
- Underpass
- Overpass
- Railroad (at grade)
- Railroad (underpass)
- Railroad (overpass)
- Intersection

Created on: 7/1/2025

transportation.ohio.gov

Prepared by  
The Ohio Department of Transportation  
Office of Technical Services  
Roadway Information



INTERCHANGE  
SR 7 & SR 775  
LAWRENCE COUNTY  
INTERCHANGE ID NUMBER = 055000

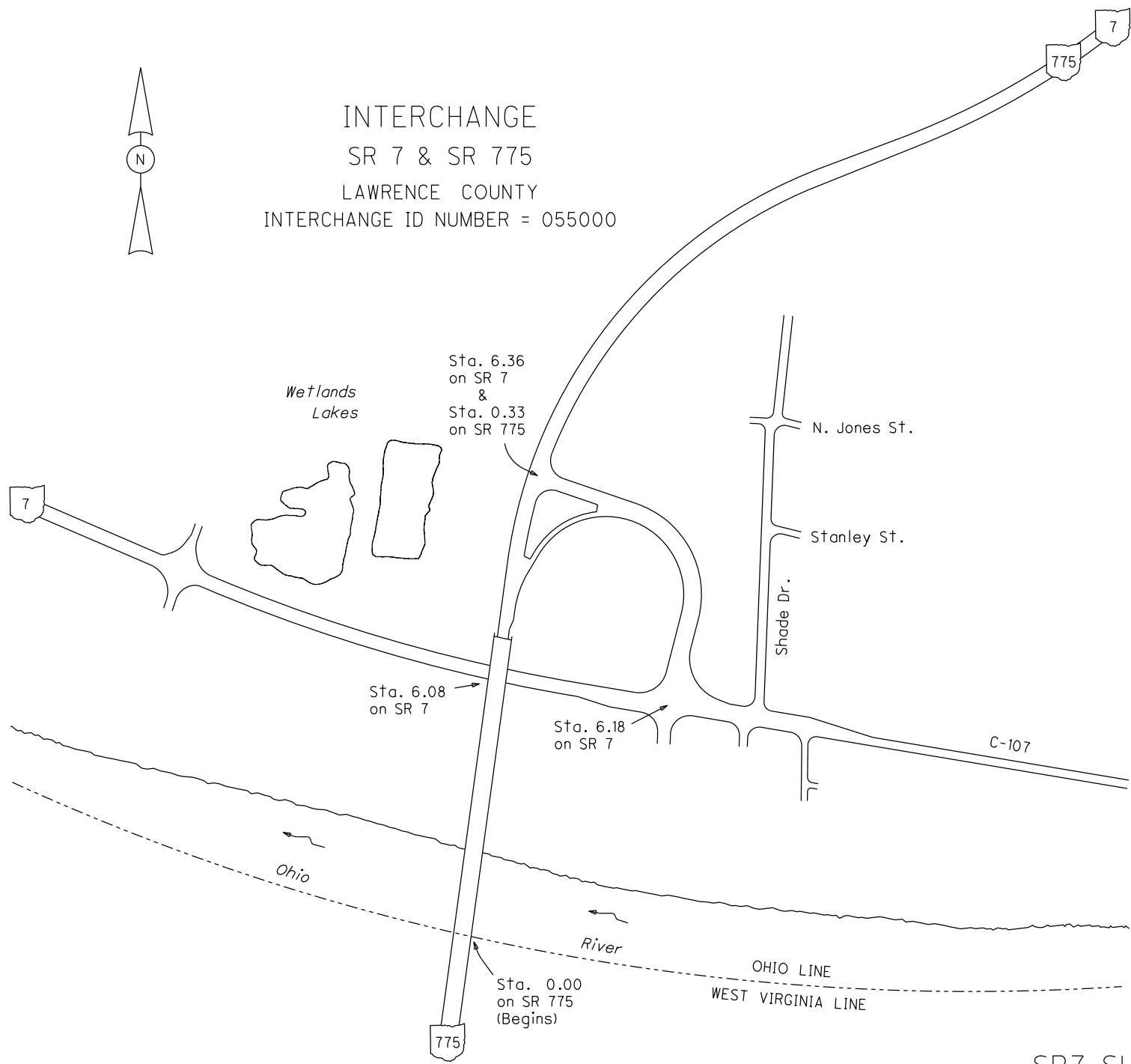

# SLAWSR00775\*\*C

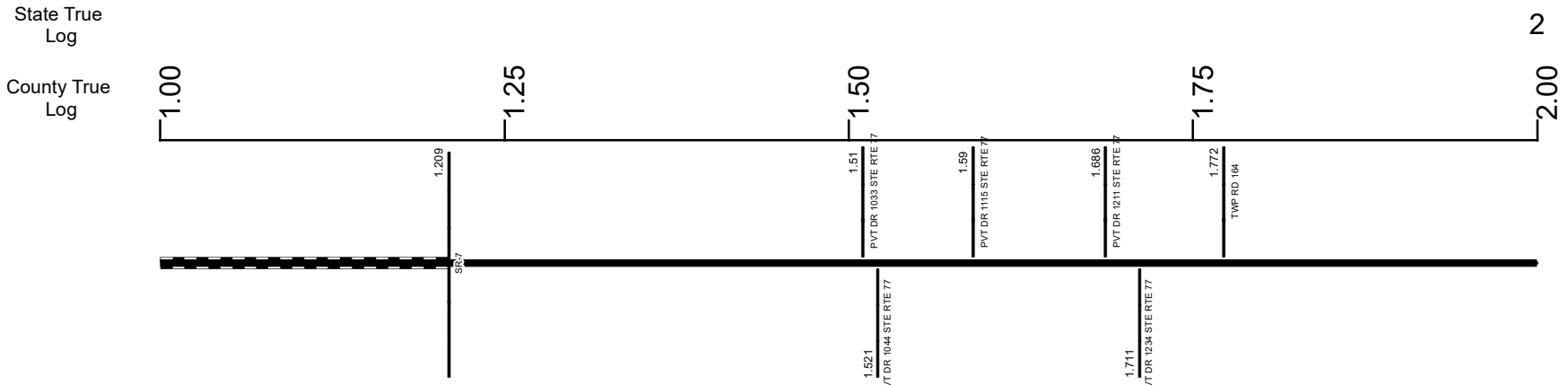

Surface Type & Width (Left / Right)	G 20' 1.209 - 3.091
Base Type (Left / Right)	I 1.209 - 3.091
Shoulder Type & Width (Left / Right)	5 (1/1') 1.209 - 3.091
Resurface Year	2023 1.209 - 9.25
Through Lanes	2 1.209 - 9.261
Street Name	SR 775 1.209 - 9.261

- Non-divided Highway
- Divided Highway
- Secondary Segment
- Corporation
- Bridge (on route)
- Underpass
- Overpass
- Railroad (at grade)
- Railroad (underpass)
- Railroad (overpass)
- Intersection

Created on: 7/1/2025



transportation.ohio.gov  
Prepared by  
The Ohio Department of Transportation  
Office of Technical Services  
Roadway Information

# SLAWSR00775\*\*C

State True Log

3

County True Log

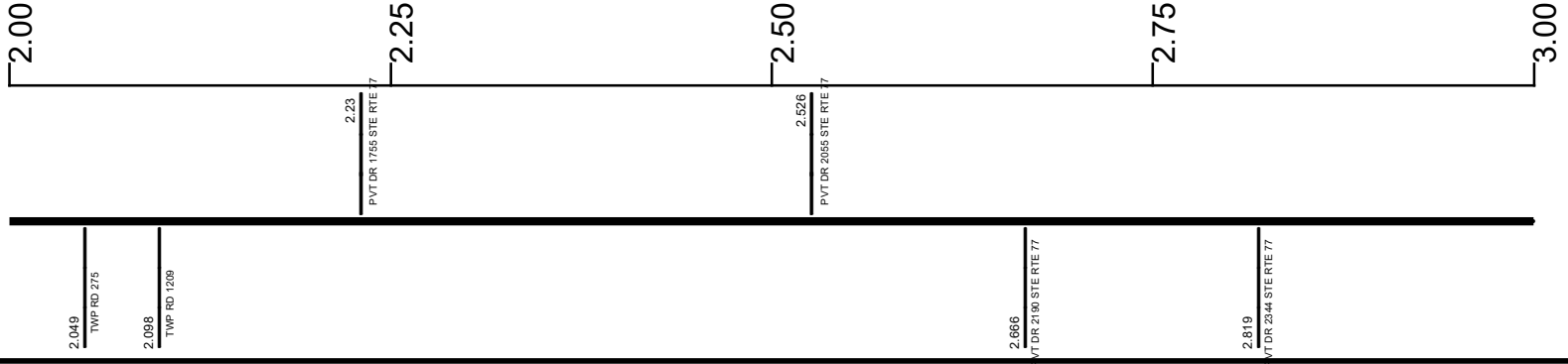

Surface Type & Width (Left / Right)	G 20'
	1.209 - 3.091
Base Type (Left / Right)	I
	1.209 - 3.091
Shoulder Type & Width (Left / Right)	5 (1/1')
	1.209 - 3.091
Resurface Year	2023
	1.209 - 9.25
Through Lanes	2
	1.209 - 9.261
Street Name	SR 775
	1.209 - 9.261

- |  |   |   |   |
|--|---|---|---|
| <ul style="list-style-type: none"> <li> Non-divided Highway</li> <li> Divided Highway</li> <li> Secondary Segment</li> <li> Corporation</li> </ul> | <ul style="list-style-type: none"> <li> Bridge (on route)</li> <li> Underpass</li> <li> Overpass</li> </ul> | <ul style="list-style-type: none"> <li> Railroad (at grade)</li> <li> Railroad (underpass)</li> <li> Railroad (overpass)</li> </ul> | <ul style="list-style-type: none"> <li> Intersection</li> </ul> |
|--|---|---|---|

Created on: 7/1/2025

transportation.ohio.gov

Prepared by  
The Ohio Department of Transportation  
Office of Technical Services  
Roadway Information

# SLAWSR00775\*\*C

State True Log

County True Log

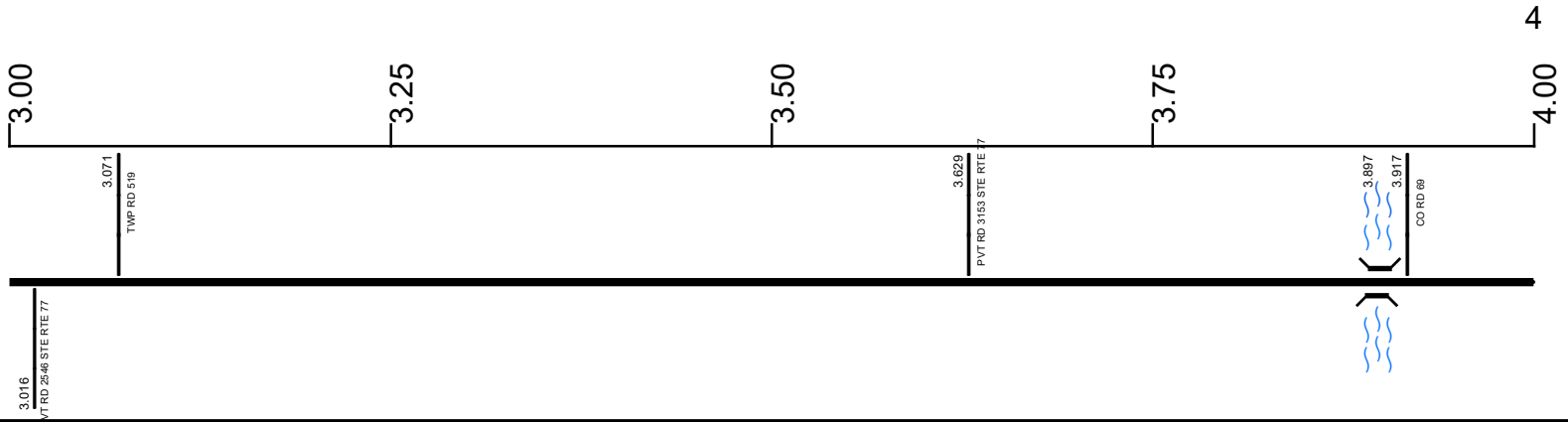

**Surface Type & Width (Left / Right)**

G 20'	G 24'	G 20'
1.209 - 3.091	3.091 - 3.459	3.459 - 4.936

**Base Type (Left / Right)**

I	L	I
1.209 - 3.091	3.091 - 3.459	3.459 - 5.842

**Shoulder Type & Width (Left / Right)**

5 (1/1')	5 (3/3')	5 (1/1')
1.209 - 3.091	3.091 - 3.459	3.459 - 5.842

**Resurface Year**

	2023	
	1.209 - 9.25	

**Through Lanes**

	2	
	1.209 - 9.261	

**Street Name**

	SR 775	
	1.209 - 9.261	

- Non-divided Highway
- Divided Highway
- Secondary Segment
- Corporation
- Bridge (on route)
- Underpass
- Overpass
- Railroad (at grade)
- Railroad (underpass)
- Railroad (overpass)
- Intersection

Created on: 7/1/2025

transportation.ohio.gov

Prepared by  
The Ohio Department of Transportation  
Office of Technical Services  
Roadway Information

# SLAWSR00775\*\*C

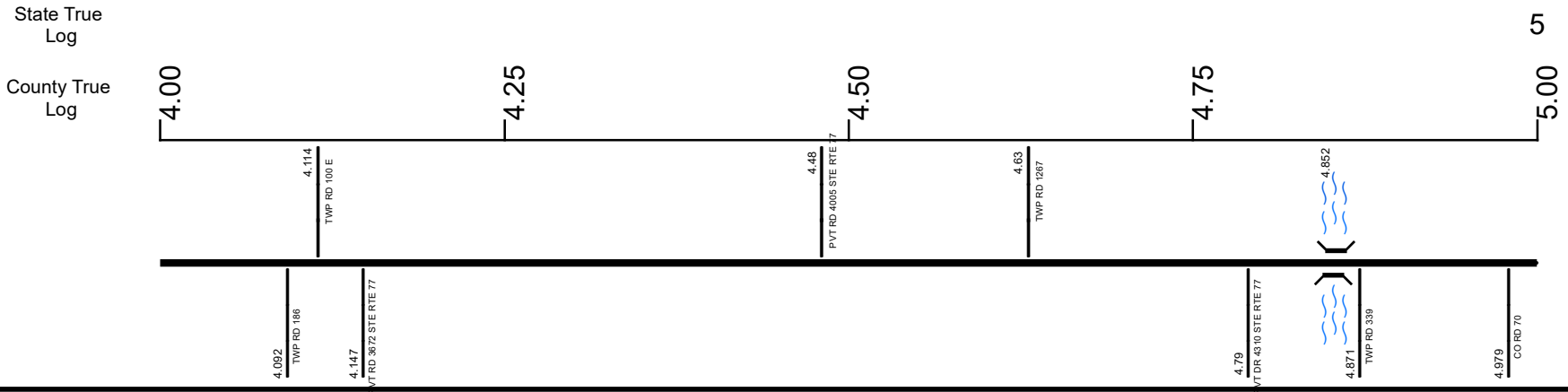

Surface Type & Width (Left / Right)	G 20' 3.459 - 4.936	G 18' 4.936 - 5.842
Base Type (Left / Right)	I 3.459 - 5.842	
Shoulder Type & Width (Left / Right)	5 (1/1) 3.459 - 5.842	
Resurface Year	2023	
Through Lanes	2 1.209 - 9.25	
Street Name	SR 775 1.209 - 9.261	

Non-divided Highway	Bridge (on route)	Railroad (at grade)	Intersection
Divided Highway	Underpass	Railroad (underpass)	
Secondary Segment	Overpass	Railroad (overpass)	
<b>Corporation</b>			

Created on: 7/1/2025

transportation.ohio.gov

Prepared by  
The Ohio Department of Transportation  
Office of Technical Services  
Roadway Information

# SLAWSR00775\*\*C

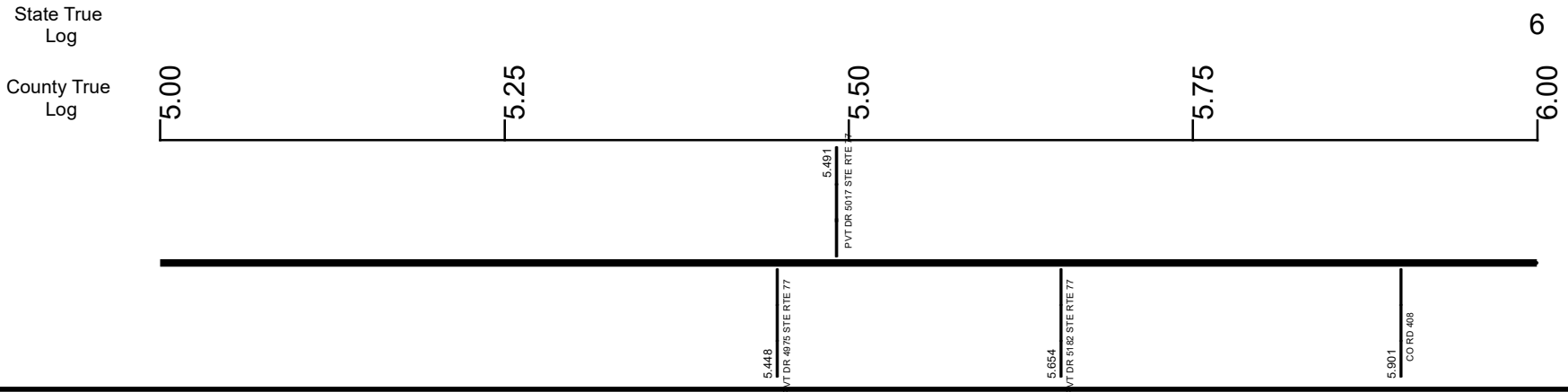

Surface Type & Width (Left / Right)	G 18' 4.936 - 5.842	G 20' 5.842 - 7.246
Base Type (Left / Right)	I 3.459 - 5.842	L 5.842 - 7.246
Shoulder Type & Width (Left / Right)	5 (1'1') 3.459 - 5.842	5 (2'2') 5.842 - 7.246
Resurface Year	2023	
Through Lanes	2 1.209 - 9.25	
Street Name	SR 775 1.209 - 9.261	

Non-divided Highway	Bridge (on route)	Railroad (at grade)	Intersection
Divided Highway	Underpass	Railroad (underpass)	
Secondary Segment	Overpass	Railroad (overpass)	
<b>Corporation</b>			

Created on: 7/1/2025



transportation.ohio.gov  
Prepared by  
The Ohio Department of Transportation  
Office of Technical Services  
Roadway Information

# SLAWSR00775\*\*C

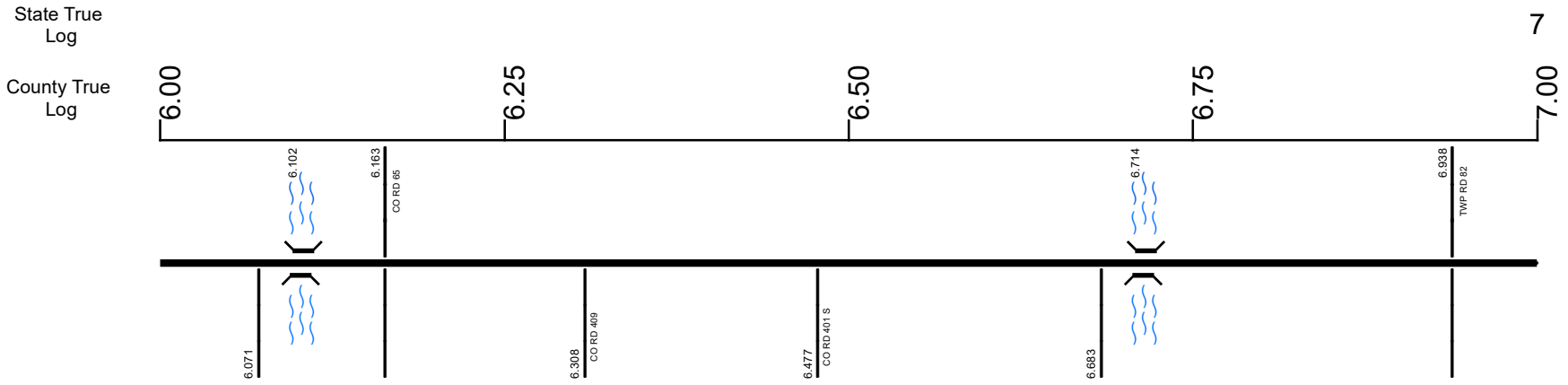

Surface Type & Width (Left / Right)	G 20'
	5.842 - 7.246
Base Type (Left / Right)	L
	5.842 - 7.246
Shoulder Type & Width (Left / Right)	5 (2 1/2')
	5.842 - 7.246
Resurface Year	2023
Through Lanes	2
	1.209 - 9.261
Street Name	SR 775
	1.209 - 9.261

- |  |   |   |   |
|--|---|---|---|
| <ul style="list-style-type: none"> <li> Non-divided Highway</li> <li> Divided Highway</li> <li> Secondary Segment</li> <li> Corporation</li> </ul> | <ul style="list-style-type: none"> <li> Bridge (on route)</li> <li> Underpass</li> <li> Overpass</li> </ul> | <ul style="list-style-type: none"> <li> Railroad (at grade)</li> <li> Railroad (underpass)</li> <li> Railroad (overpass)</li> </ul> | <ul style="list-style-type: none"> <li> Intersection</li> </ul> |
|--|---|---|---|

Created on: 7/1/2025

transportation.ohio.gov

Prepared by  
The Ohio Department of Transportation  
Office of Technical Services  
Roadway Information

# SLAWSR00775\*\*C

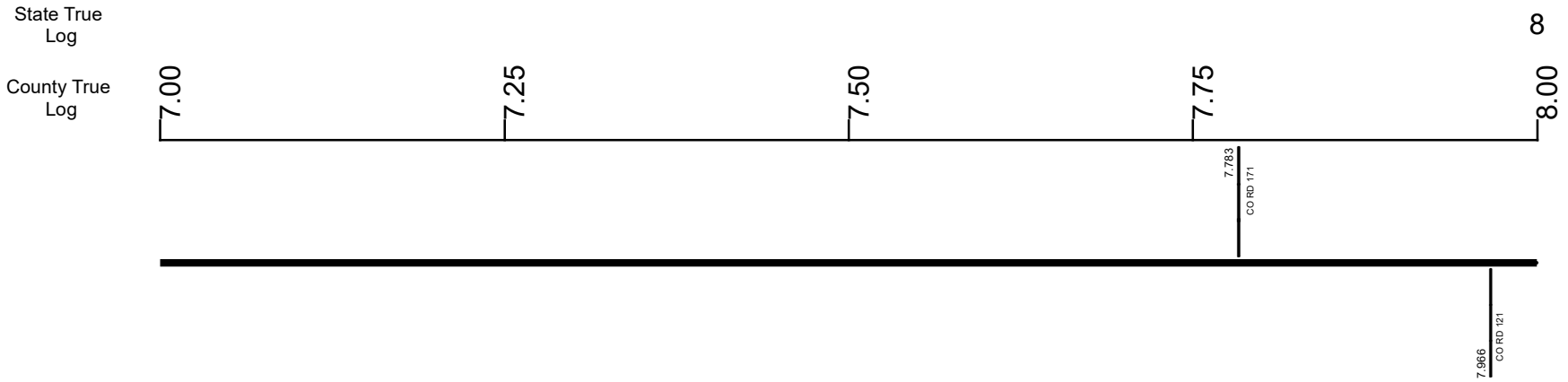

**Surface Type & Width (Left / Right)**

G 20'	G 18'
5.842 - 7.246	7.246 - 9.08

**Base Type (Left / Right)**

L	I
5.842 - 7.246	7.246 - 9.261

**Shoulder Type & Width (Left / Right)**

5 (2'1/2')	5 (1'1/1')
5.842 - 7.246	7.246 - 9.08

**Resurface Year**

	2023
	1.209 - 9.25

**Through Lanes**

	2
	1.209 - 9.261

**Street Name**

	SR 775
	1.209 - 9.261

- |                     |                   |                      |              |
|---------------------|-------------------|----------------------|--------------|
| Non-divided Highway | Bridge (on route) | Railroad (at grade)  | Intersection |
| Divided Highway     | Underpass         | Railroad (underpass) |              |
| Secondary Segment   | Overpass          | Railroad (overpass)  |              |
| Corporation         |                   |                      |              |

Created on: 7/1/2025

transportation.ohio.gov

Prepared by  
The Ohio Department of Transportation  
Office of Technical Services  
Roadway Information

# SLAWSR00775\*\*C

State True Log

County True Log

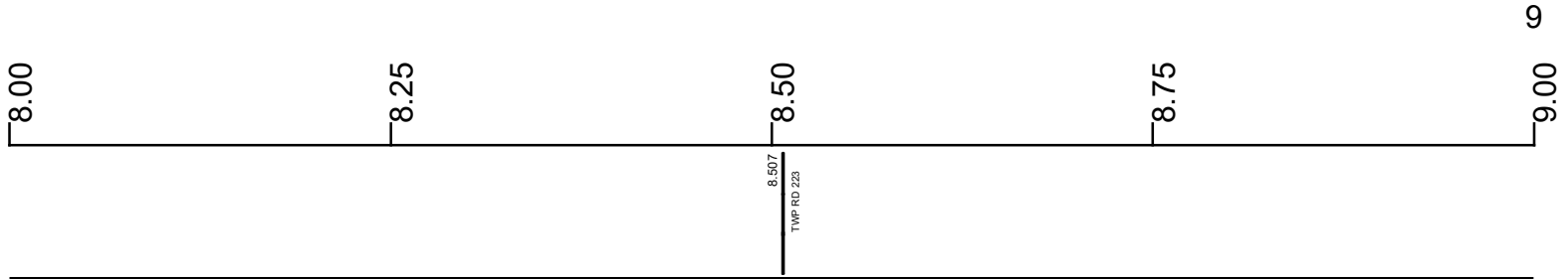

Surface Type & Width (Left / Right)

G 18'  
7.246 - 9.08

Base Type (Left / Right)

I  
7.246 - 9.261

Shoulder Type & Width (Left / Right)

5 (1/1')  
7.246 - 9.08

Resurface Year

2023  
1.209 - 9.25

Through Lanes

2  
1.209 - 9.261

Street Name

SR 775  
1.209 - 9.261

- Non-divided Highway
  Bridge (on route)
  Railroad (at grade)
  Intersection
- Divided Highway
  Underpass
  Railroad (underpass)
- Secondary Segment
  Overpass
  Railroad (overpass)
- Corporation**

Created on: 7/1/2025



transportation.ohio.gov

Prepared by  
The Ohio Department of Transportation  
Office of Technical Services  
Roadway Information

# SLAWSR00775\*\*C

State True Log

County True Log

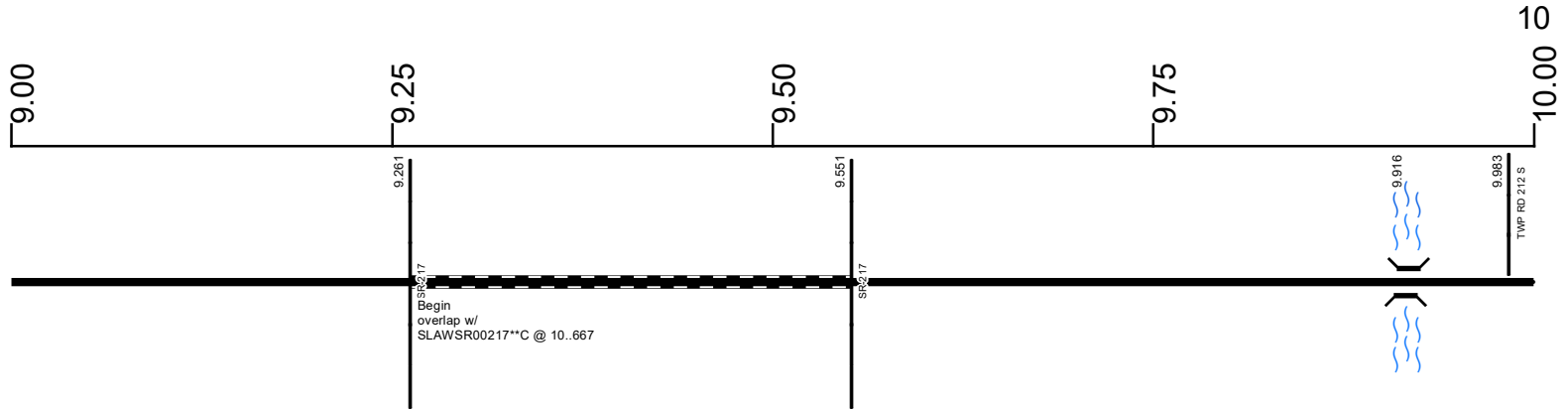

**Surface Type & Width (Left / Right)**

G 18'	G 20'
7.246 - 9.08	9.08 - 9.261

**Base Type (Left / Right)**

I
7.246 - 9.261

**Shoulder Type & Width (Left / Right)**

5 (1'1')	5 (3'3')
7.246 - 9.08	9.08 - 9.261

**Resurface Year**

2023
------

1.209 - 9.25

**Through Lanes**

2
1.209 - 9.261

SR 775
1.209 - 9.261

**Surface Type & Width (Left / Right)**

G 20'
9.551 - 16.683

**Base Type (Left / Right)**

I
9.551 - 23.959

**Shoulder Type & Width (Left / Right)**

2 (2'2')
9.551 - 16.683

**Resurface Year**

2022
------

9.551 - 18.5

**Through Lanes**

2
9.551 - 23.959

SR 775
9.551 - 23.959

- Non-divided Highway
- Divided Highway
- Secondary Segment
- Corporation
- Bridge (on route)
- Underpass
- Overpass
- Railroad (at grade)
- Railroad (underpass)
- Railroad (overpass)
- Intersection

Created on: 7/1/2025

transportation.ohio.gov

Prepared by  
The Ohio Department of Transportation  
Office of Technical Services  
Roadway Information

# SLAWSR00775\*\*C

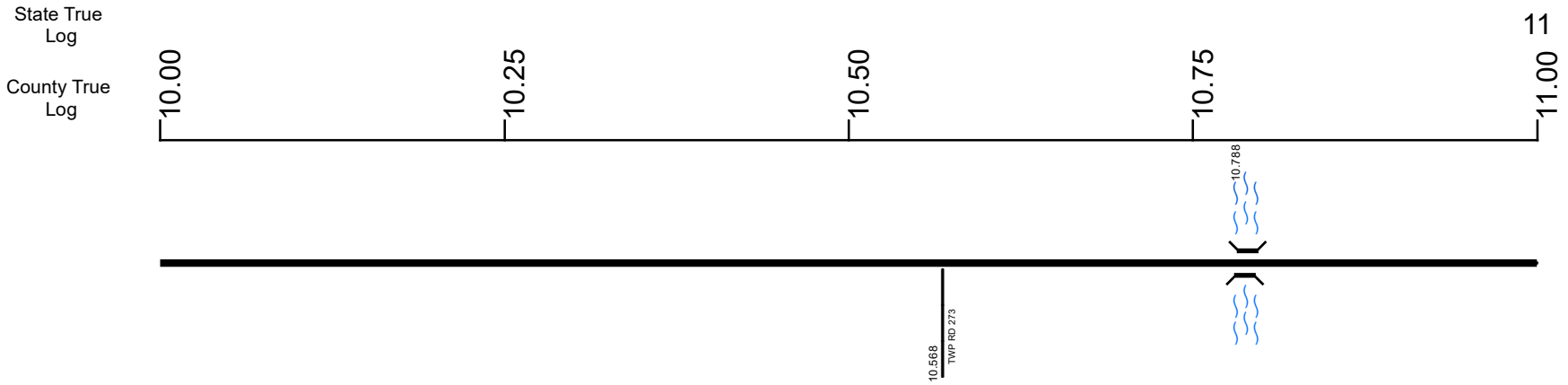

Surface Type & Width (Left / Right)	G 20'
	9.551 - 16.683
Base Type (Left / Right)	I
	9.551 - 23.959
Shoulder Type & Width (Left / Right)	2 (2'/2')
	9.551 - 16.683
Resurface Year	2022
	9.551 - 18.5
Through Lanes	2
	9.551 - 23.959
Street Name	SR 775
	9.551 - 23.959

- Non-divided Highway
- Divided Highway
- Secondary Segment
- Corporation
- Bridge (on route)
- Underpass
- Overpass
- Railroad (at grade)
- Railroad (underpass)
- Railroad (overpass)
- Intersection

Created on: 7/1/2025

transportation.ohio.gov  
Prepared by  
The Ohio Department of Transportation  
Office of Technical Services  
Roadway Information

# SLAWSR00775\*\*C

State True Log

County True Log

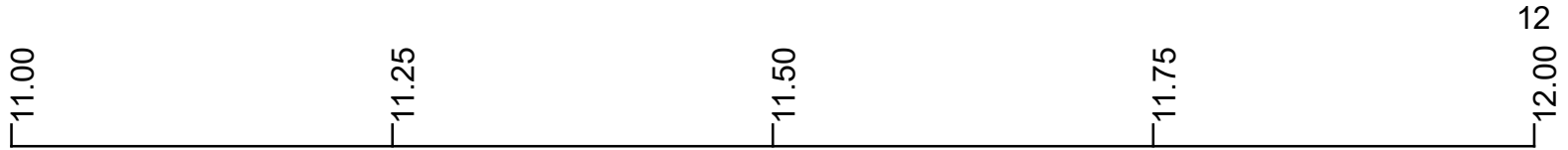

Surface Type & Width (Left / Right)

G 20'  
9.551 - 16.683

Base Type (Left / Right)

I  
9.551 - 23.959

Shoulder Type & Width (Left / Right)

2 (2'/2')  
9.551 - 16.683

Resurface Year

2022  
9.551 - 18.5

Through Lanes

2  
9.551 - 23.959

Street Name

SR 775  
9.551 - 23.959

- Non-divided Highway
  Bridge (on route)
  Railroad (at grade)
  Intersection
- Divided Highway
  Underpass
  Railroad (underpass)
- Secondary Segment
  Overpass
  Railroad (overpass)
- Corporation**

Created on: 7/1/2025

Prepared by  
 The Ohio Department of Transportation  
 Office of Technical Services  
 Roadway Information

# SLAWSR00775\*\*C

State True Log

County True Log

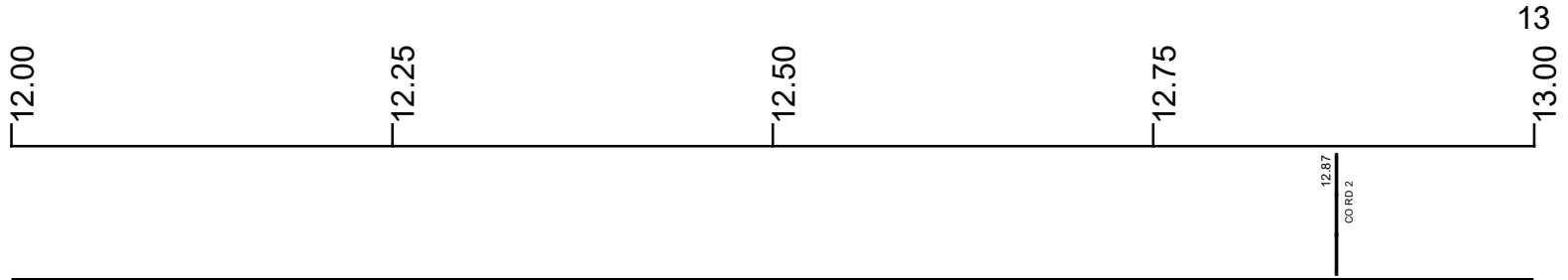

Surface Type & Width (Left / Right)

G 20'  
9.551 - 16.683

Base Type (Left / Right)

I  
9.551 - 23.959

Shoulder Type & Width (Left / Right)

2 (2'/2')  
9.551 - 16.683

Resurface Year

2022  
9.551 - 18.5

Through Lanes

2  
9.551 - 23.959

Street Name

SR 775  
9.551 - 23.959

- |                     |                   |                      |              |
|---------------------|-------------------|----------------------|--------------|
| Non-divided Highway | Bridge (on route) | Railroad (at grade)  | Intersection |
| Divided Highway     | Underpass         | Railroad (underpass) |              |
| Secondary Segment   | Overpass          | Railroad (overpass)  |              |
| Corporation         |                   |                      |              |

Created on: 7/1/2025



transportation.ohio.gov  
 Prepared by  
 The Ohio Department of Transportation  
 Office of Technical Services  
 Roadway Information

# SLAWSR00775\*\*C

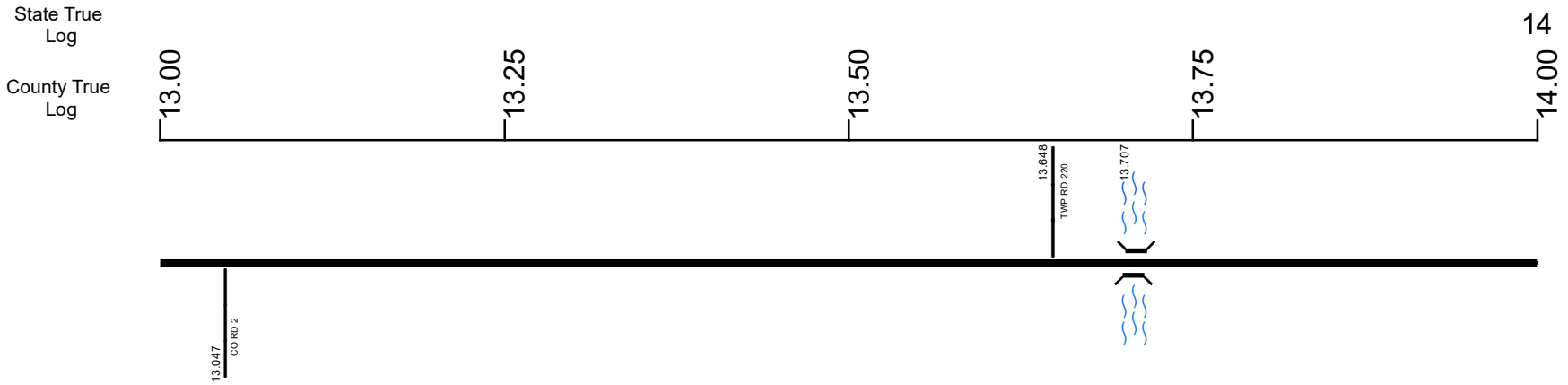

Surface Type & Width (Left / Right)	G 20'
	9.551 - 16.683
Base Type (Left / Right)	I
	9.551 - 23.959
Shoulder Type & Width (Left / Right)	2 (2'/2')
	9.551 - 16.683
Resurface Year	2022
	9.551 - 18.5
Through Lanes	2
	9.551 - 23.959
Street Name	SR 775
	9.551 - 23.959

	Non-divided Highway		Bridge (on route)		Railroad (at grade)		Intersection
	Divided Highway		Underpass		Railroad (underpass)		
	Secondary Segment		Overpass		Railroad (overpass)		
	Corporation						

Created on: 7/1/2025

transportation.ohio.gov

Prepared by  
The Ohio Department of Transportation  
Office of Technical Services  
Roadway Information

# SLAWSR00775\*\*C

State True Log  
County True Log

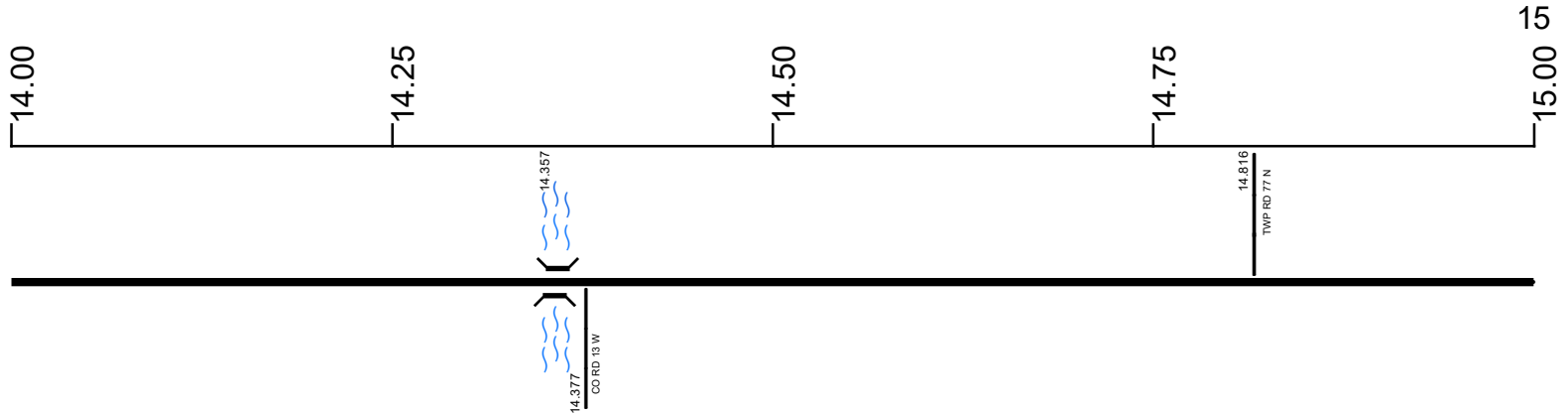

Surface Type & Width (Left / Right)	G 20'
	9.551 - 16.683
Base Type (Left / Right)	I
	9.551 - 23.959
Shoulder Type & Width (Left / Right)	2 (2'/2')
	9.551 - 16.683
Resurface Year	2022
	9.551 - 18.5
Through Lanes	2
	9.551 - 23.959
Street Name	SR 775
	9.551 - 23.959

- Non-divided Highway
- Divided Highway
- Secondary Segment
- Corporation
- Bridge (on route)
- Underpass
- Overpass
- Railroad (at grade)
- Railroad (underpass)
- Railroad (overpass)
- Intersection

Created on: 7/1/2025



transportation.ohio.gov  
 Prepared by  
 The Ohio Department of Transportation  
 Office of Technical Services  
 Roadway Information

# SLAWSR00775\*\*C

State True Log  
County True Log

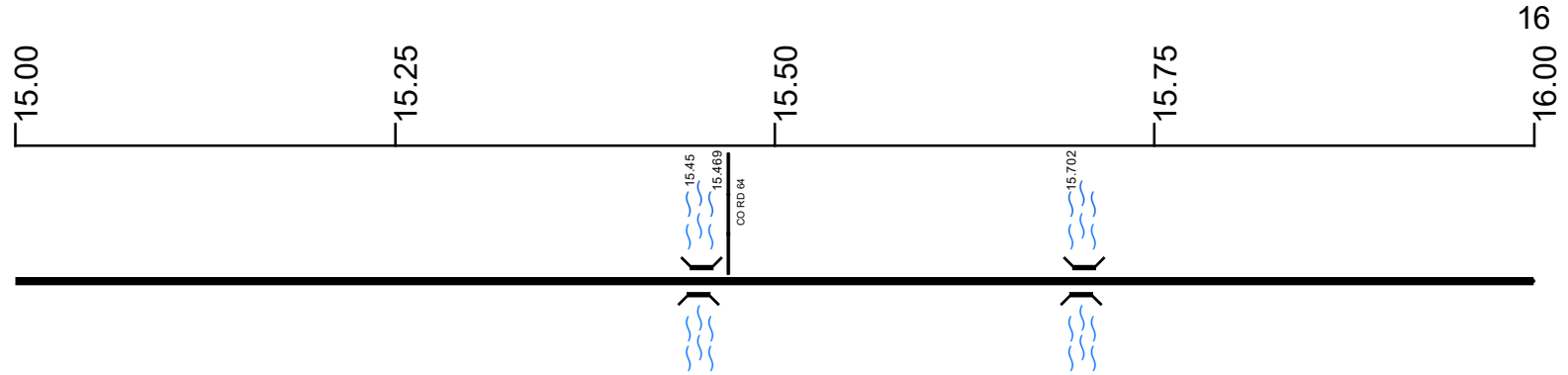

Surface Type & Width (Left / Right)	G 20'
	9.551 - 16.683
Base Type (Left / Right)	I
	9.551 - 23.959
Shoulder Type & Width (Left / Right)	2 (2 1/2')
	9.551 - 16.683
Resurface Year	2022
	9.551 - 18.5
Through Lanes	2
	9.551 - 23.959
Street Name	SR 775
	9.551 - 23.959

Non-divided Highway	Bridge (on route)	Railroad (at grade)	Intersection
Divided Highway	Underpass	Railroad (underpass)	
Secondary Segment	Overpass	Railroad (overpass)	
Corporation			

Created on: 7/1/2025

# SLAWSR00775\*\*C

State True Log  
County True Log

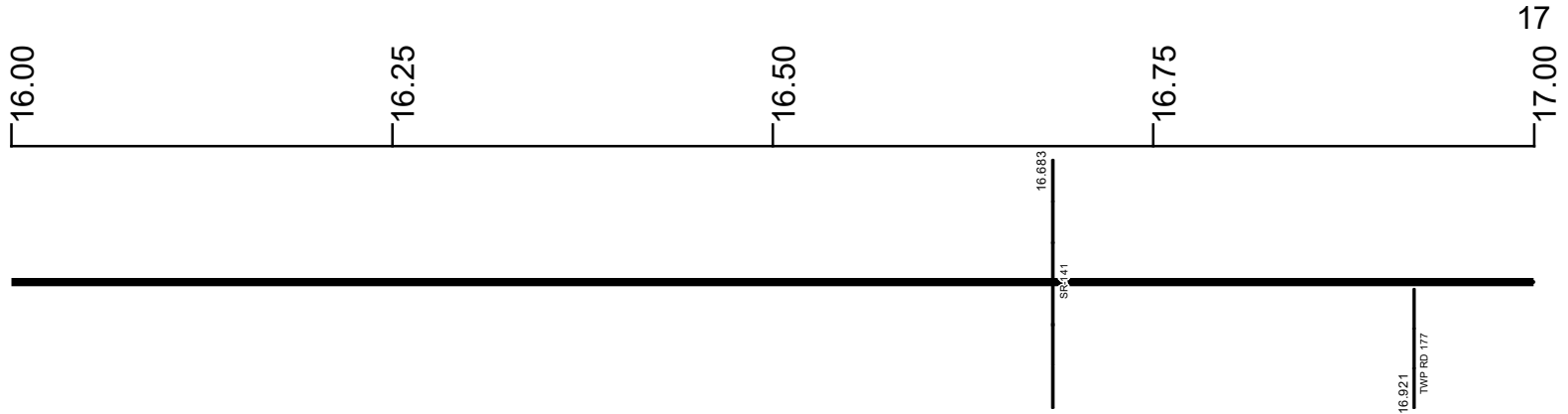

**Surface Type & Width (Left / Right)**

G 20'	G 18'
9.551 - 16.683	16.683 - 17.625

**Base Type (Left / Right)**

I	
9.551 - 23.959	

**Shoulder Type & Width (Left / Right)**

2 (2'1/2')	5 (1'1')
9.551 - 16.683	16.683 - 23.959

**Resurface Year**

2022	
9.551 - 18.5	

**Through Lanes**

2	
9.551 - 23.959	

**Street Name**

SR 775	
9.551 - 23.959	

- |  |   |   |   |
|--|---|---|---|
| <ul style="list-style-type: none"> <li> Non-divided Highway</li> <li> Divided Highway</li> <li> Secondary Segment</li> <li> Corporation</li> </ul> | <ul style="list-style-type: none"> <li> Bridge (on route)</li> <li> Underpass</li> <li> Overpass</li> </ul> | <ul style="list-style-type: none"> <li> Railroad (at grade)</li> <li> Railroad (underpass)</li> <li> Railroad (overpass)</li> </ul> | <ul style="list-style-type: none"> <li> Intersection</li> </ul> |
|--|---|---|---|

Created on: 7/1/2025

transportation.ohio.gov

Prepared by  
The Ohio Department of Transportation  
Office of Technical Services  
Roadway Information

# SLAWSR00775\*\*C

State True Log  
County True Log

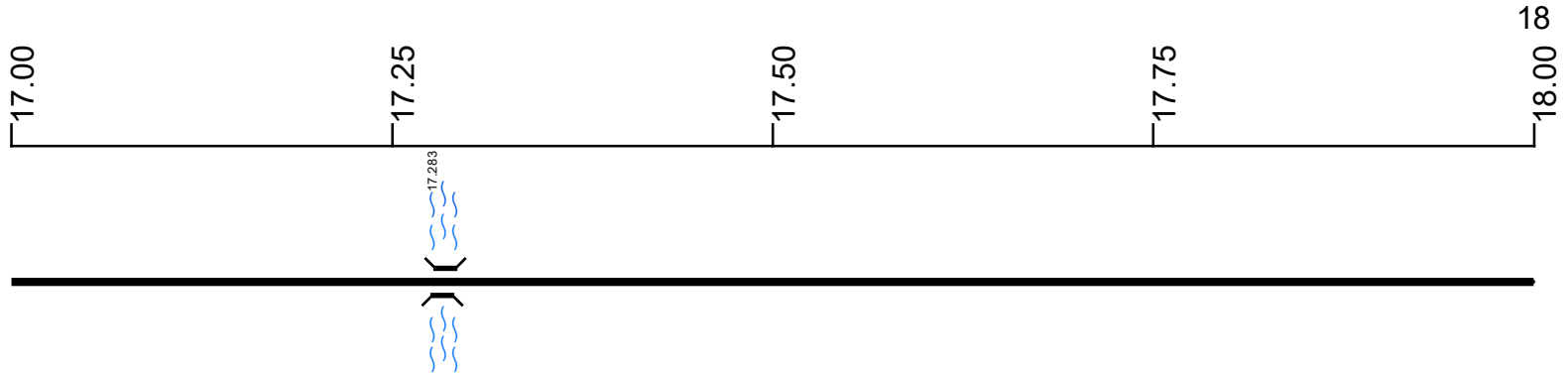

**Surface Type & Width (Left / Right)**

G 18'	G 20'
16.683 - 17.625	17.625 - 18.445

**Base Type (Left / Right)**

I	I
9.551 - 23.959	9.551 - 23.959

**Shoulder Type & Width (Left / Right)**

5 (1/1')	5 (1/1')
16.683 - 23.959	16.683 - 23.959

**Resurface Year**

2022	2022
------	------

**Through Lanes**

2	2
9.551 - 18.5	9.551 - 18.5

**Street Name**

SR 775	SR 775
9.551 - 23.959	9.551 - 23.959

- Non-divided Highway
- Divided Highway
- Secondary Segment
- Corporation
- Bridge (on route)
- Underpass
- Overpass
- Railroad (at grade)
- Railroad (underpass)
- Railroad (overpass)
- Intersection

Created on: 7/1/2025

transportation.ohio.gov  
Prepared by  
The Ohio Department of Transportation  
Office of Technical Services  
Roadway Information

# SLAWSR00775\*\*C

State True Log  
County True Log

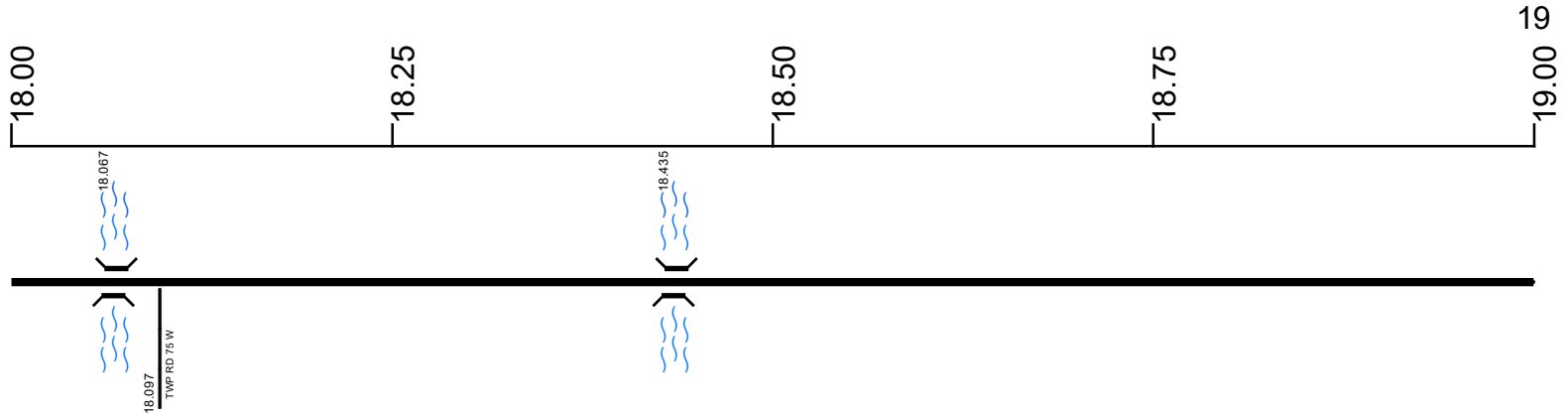

Surface Type & Width (Left / Right)	G 20' / G 18'
	17.625 - 18.445 / 18.445 - 19.478
Base Type (Left / Right)	I
	9.551 - 23.959
Shoulder Type & Width (Left / Right)	5 (1/1')
	16.683 - 23.959
Resurface Year	2022
	9.551 - 18.5
Through Lanes	2
	9.551 - 23.959
Street Name	SR 775
	9.551 - 23.959

- |                     |                   |                      |              |
|---------------------|-------------------|----------------------|--------------|
| Non-divided Highway | Bridge (on route) | Railroad (at grade)  | Intersection |
| Divided Highway     | Underpass         | Railroad (underpass) |              |
| Secondary Segment   | Overpass          | Railroad (overpass)  |              |
| Corporation         |                   |                      |              |

Created on: 7/1/2025

transportation.ohio.gov

Prepared by  
The Ohio Department of Transportation  
Office of Technical Services  
Roadway Information

# SLAWSR00775\*\*C

State True Log  
County True Log

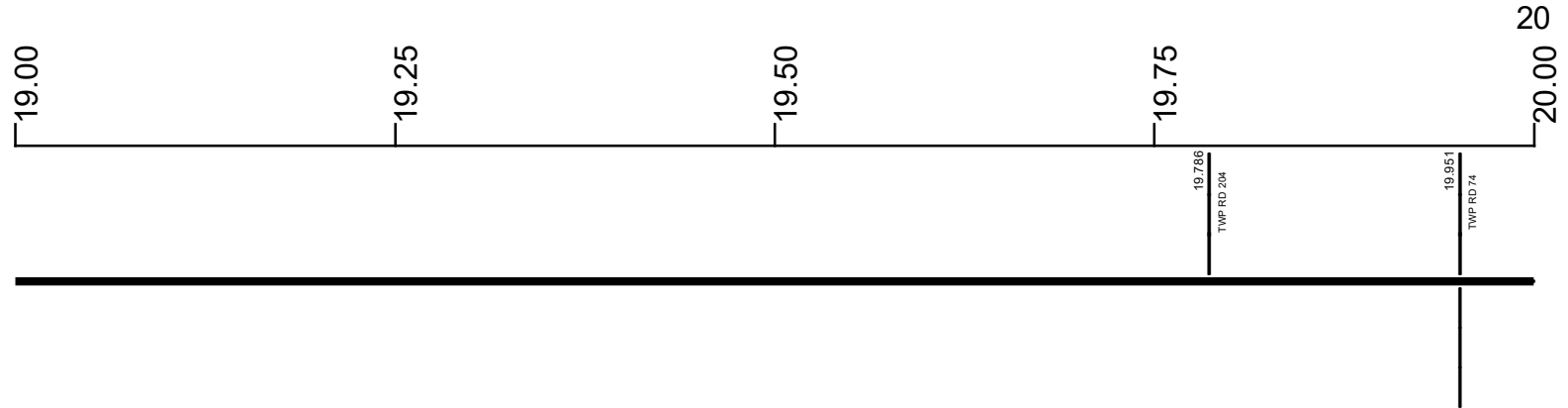

**Surface Type & Width (Left / Right)**

G 18'	G 20'	G 18'
18.445 - 19.478	19.478 - 19.716	19.716 - 23.959

**Base Type (Left / Right)**

I
9.551 - 23.959

**Shoulder Type & Width (Left / Right)**

5 (1/1')
16.683 - 23.959

**Through Lanes**

2
9.551 - 23.959

**Street Name**

SR 775
9.551 - 23.959

- Non-divided Highway
- Divided Highway
- Secondary Segment
- Corporation
- Bridge (on route)
- Underpass
- Overpass
- Railroad (at grade)
- Railroad (underpass)
- Railroad (overpass)
- Intersection

Created on: 7/1/2025

transportation.ohio.gov

Prepared by  
The Ohio Department of Transportation  
Office of Technical Services  
Roadway Information

# SLAWSR00775\*\*C

State True Log

21

County True Log



Surface Type & Width (Left / Right)

G 18'  
19.716 - 23.959

Base Type (Left / Right)

I  
9.551 - 23.959

Shoulder Type & Width (Left / Right)

5 (1/1')  
16.683 - 23.959

Through Lanes

2  
9.551 - 23.959

Street Name

SR 775  
9.551 - 23.959

- |                     |                   |                      |              |
|---------------------|-------------------|----------------------|--------------|
| Non-divided Highway | Bridge (on route) | Railroad (at grade)  | Intersection |
| Divided Highway     | Underpass         | Railroad (underpass) |              |
| Secondary Segment   | Overpass          | Railroad (overpass)  |              |
| <b>Corporation</b>  |                   |                      |              |

Created on: 7/1/2025

transportation.ohio.gov

Prepared by  
The Ohio Department of Transportation  
Office of Technical Services  
Roadway Information

# SLAWSR00775\*\*C

State True Log  
County True Log

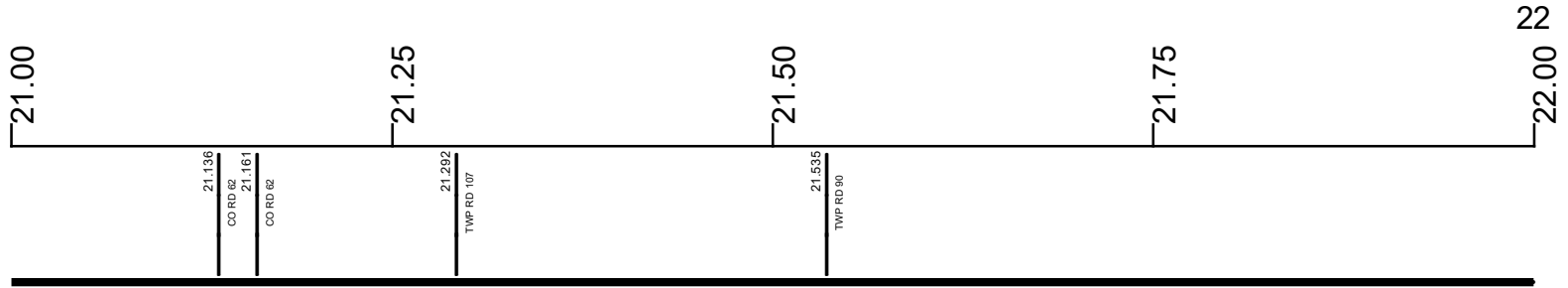

**Surface Type & Width (Left / Right)**

G 18'  
19.716 - 23.959

**Base Type (Left / Right)**

I  
9.551 - 23.959

**Shoulder Type & Width (Left / Right)**

5 (1/1')  
16.683 - 23.959

**Through Lanes**

2  
9.551 - 23.959

**Street Name**

SR 775  
9.551 - 23.959

- |                     |                   |                      |              |
|---------------------|-------------------|----------------------|--------------|
| Non-divided Highway | Bridge (on route) | Railroad (at grade)  | Intersection |
| Divided Highway     | Underpass         | Railroad (underpass) |              |
| Secondary Segment   | Overpass          | Railroad (overpass)  |              |
| Corporation         |                   |                      |              |

Created on: 7/1/2025



transportation.ohio.gov  
Prepared by  
The Ohio Department of Transportation  
Office of Technical Services  
Roadway Information

# SLAWSR00775\*\*C

State True Log

23

County True Log

22.00

22.25

22.50

22.75

23.00



Surface Type & Width (Left / Right)

G 18'  
19.716 - 23.959

Base Type (Left / Right)

I  
9.551 - 23.959

Shoulder Type & Width (Left / Right)

5 (1/1')  
16.683 - 23.959

Through Lanes

2  
9.551 - 23.959

Street Name

SR 775  
9.551 - 23.959

- Non-divided Highway
  Bridge (on route)
  Railroad (at grade)
  Intersection
- Divided Highway
  Underpass
  Railroad (underpass)
- Secondary Segment
  Overpass
  Railroad (overpass)
- Corporation**

Created on: 7/1/2025



transportation.ohio.gov

Prepared by  
The Ohio Department of Transportation  
Office of Technical Services  
Roadway Information

# SLAWSR00775\*\*C

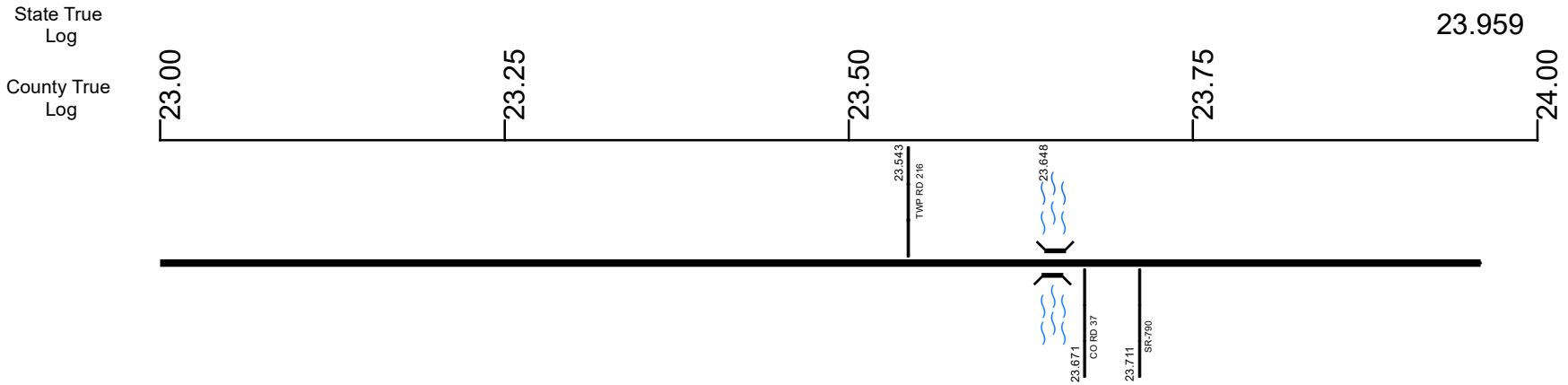

Surface Type & Width (Left / Right)	G 18'
	19.716 - 23.959
Base Type (Left / Right)	I
	9.551 - 23.959
Shoulder Type & Width (Left / Right)	5 (1/1')
	16.683 - 23.959
Through Lanes	2
	9.551 - 23.959
Street Name	SR 775
	9.551 - 23.959

	Non-divided Highway		Bridge (on route)		Railroad (at grade)		Intersection
	Divided Highway		Underpass		Railroad (underpass)		
	Secondary Segment		Overpass		Railroad (overpass)		
	<b>Corporation</b>						

Created on: 7/1/2025

transportation.ohio.gov

Prepared by  
The Ohio Department of Transportation  
Office of Technical Services  
Roadway Information

## Historical Project List for SLAWSR00775\*\*C

Begin Measure	End Measure	Project ID Number	Construction Completion Date	Treatment Category	Treatment Type
1.209	9.250	114524	12-2023	Minor Rehabilitation	50-AC Overlay w/o Rpr
1.229	9.251	83873	11-2011	Minor Rehabilitation	60-AC Overlay w/Rpr
9.551	18.514	109834	7-2022	Minor Rehabilitation	60-AC Overlay w/Rpr
16.683	23.959	19255	6-2009	Minor Rehabilitation	60-AC Overlay w/Rpr

# Roadway Codes

## Access Control Journalized

- F - Full Access Control
- L - Limited Access Control
- N - No Access Control

## Access Control Operational

- 1 - Full Access Control
- 2 - Partial Access Control
- 3 - No Access Control

## Base Type

- F - Crack and Seat
- H - Rubblize and Roll
- I - Aggregate Base 304 or Traffic Compacted
- K - Water Bound Macadam
- L - Bituminous Concrete Mix or Penetration Macadam
- N - Plain Concrete
- P - Reinforced Concrete
- R - Brick (Flexible)
- T - Brick (Rigid)

## Direction of Travel

- B - Both (Two-way)
- F - One-way Cardinal
- T - One-way Non-cardinal

## Facility Type

- 1 - One-way Roadway
- 2 - Two-way Roadway
- 4 - Ramp
- 5 - Non-mainline
- 6 - Non-inventory Direction
- 7 - Planned / Unbuilt

## Historical Federal Aid Indicator

- N - Not a FAP Route
- Y - FAP Route

## Functional Classification

- 01 - Interstate
- 02 - Principal Arterial (Freeways)
- 03 - Principal Arterial (Other)
- 04 - Minor Arterial
- 05 - Major Collector
- 06 - Minor Collector
- 07 - Local

## Leave / Reenter Indicator

- Y - Route leaves/reenters at this point
- N - Route does not leave/reenter at this point

## Median Type

- 1 - None
- 2 - Unprotected
- 3 - Curbed
- 4 - Positive Barrier (Unspecified)
- 5 - Positive Barrier (Flexible)
- 6 - Positive Barrier (Semi-rigid)
- 7 - Positive Barrier (Rigid)

## NHS

- N - National Highway System
- H - Congressional Corridor
- 2 - Major Airport
- 3 - Major Port Facility
- 4 - Major Amtrak Station
- 5 - Major Rail / Truck Terminal
- 6 - Major Intercity Bus Terminal
- 7 - Major Public Transit / Multi-modal Passenger Terminal
- 8 - Major Pipeline Terminal
- 9 - Major Ferry Terminal

## Priority System

- G - General
- P - Priority System
- U - Urban

## Scenic Byway Code

- A - All American Road
- N - National Scenic Byway
- S - State Scenic Byway

## Shoulder Type

- 1 - None
- 2 - Surfaced shoulder exists (bituminous concrete {AC})
- 3 - Surfaced shoulder exists (Portland Cement Concrete {PCC})
- 4 - Stabilized shoulder exists (gravel or other granular material)
- 5 - Combination shoulder exists (two or more surface types)
- 6 - Earth shoulder exists
- 7 - Barrier curb exists; no shoulder in front of curb

## Surface Type

- A - Combination
- B - Brick
- C - Continuous Reinforced Concrete
- D - Reinforced Concrete
- E - Plain Concrete
- G - Bituminous Concrete
- I - Chipseal on Granular
- K - Open Graded Bituminous
- L - Chipseal or Micro
- M - Gravel
- U - Unimproved
- X - Right of Way Only