

# SLUCSR00184\*\*C

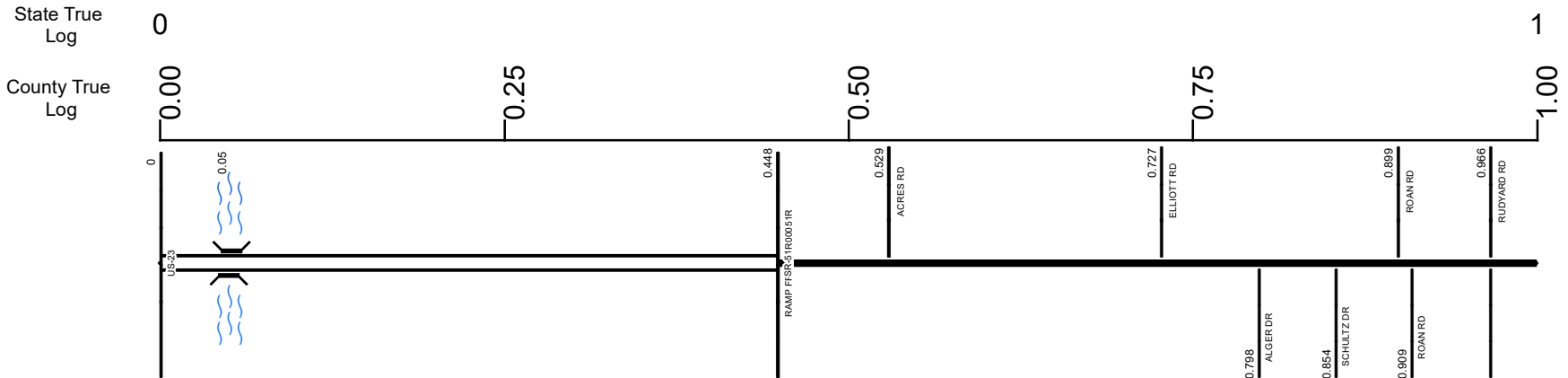

<b>Surface Type &amp; Width (Left / Right)</b>	
G 32'	G 54'
0 - 0.529	0.529 - 3.694
<b>Base Type (Left / Right)</b>	
P	N
0 - 0.529	0.529 - 3.694
<b>Shoulder Type &amp; Width (Left / Right)</b>	
1 (0'/0')	
0 - 10.114	
<b>Median Type and Width</b>	
2 ( 99' )	
0 - 0.448	
<b>Resurface Year</b>	<b>Resurface Year</b>
2021	2020
0 - 0.066	0.492 - 0.761
<b>Through Lanes</b>	
2	4
0 - 0.529	0.529 - 10.114
<b>Street Name</b>	
SR 184	W ALEXIS RD
0 - 0.448	0.448 - 0.529 0.529 - 7.663

- |  |   |   |   |
|--|---|---|---|
| <ul style="list-style-type: none"> <li> Non-divided Highway</li> <li> Divided Highway</li> <li> Secondary Segment</li> <li> Corporation</li> </ul> | <ul style="list-style-type: none"> <li> Bridge (on route)</li> <li> Underpass</li> <li> Overpass</li> </ul> | <ul style="list-style-type: none"> <li> Railroad (at grade)</li> <li> Railroad (underpass)</li> <li> Railroad (overpass)</li> </ul> | <ul style="list-style-type: none"> <li> Intersection</li> </ul> |
|--|---|---|---|

transportation.ohio.gov

Prepared by  
The Ohio Department of Transportation  
Office of Technical Services  
Roadway Information



INTERCHANGE  
USs 23 & 223,  
SRs 51 & 184  
LUCAS COUNTY  
INTERCHANGE ID NUMBER = 061900

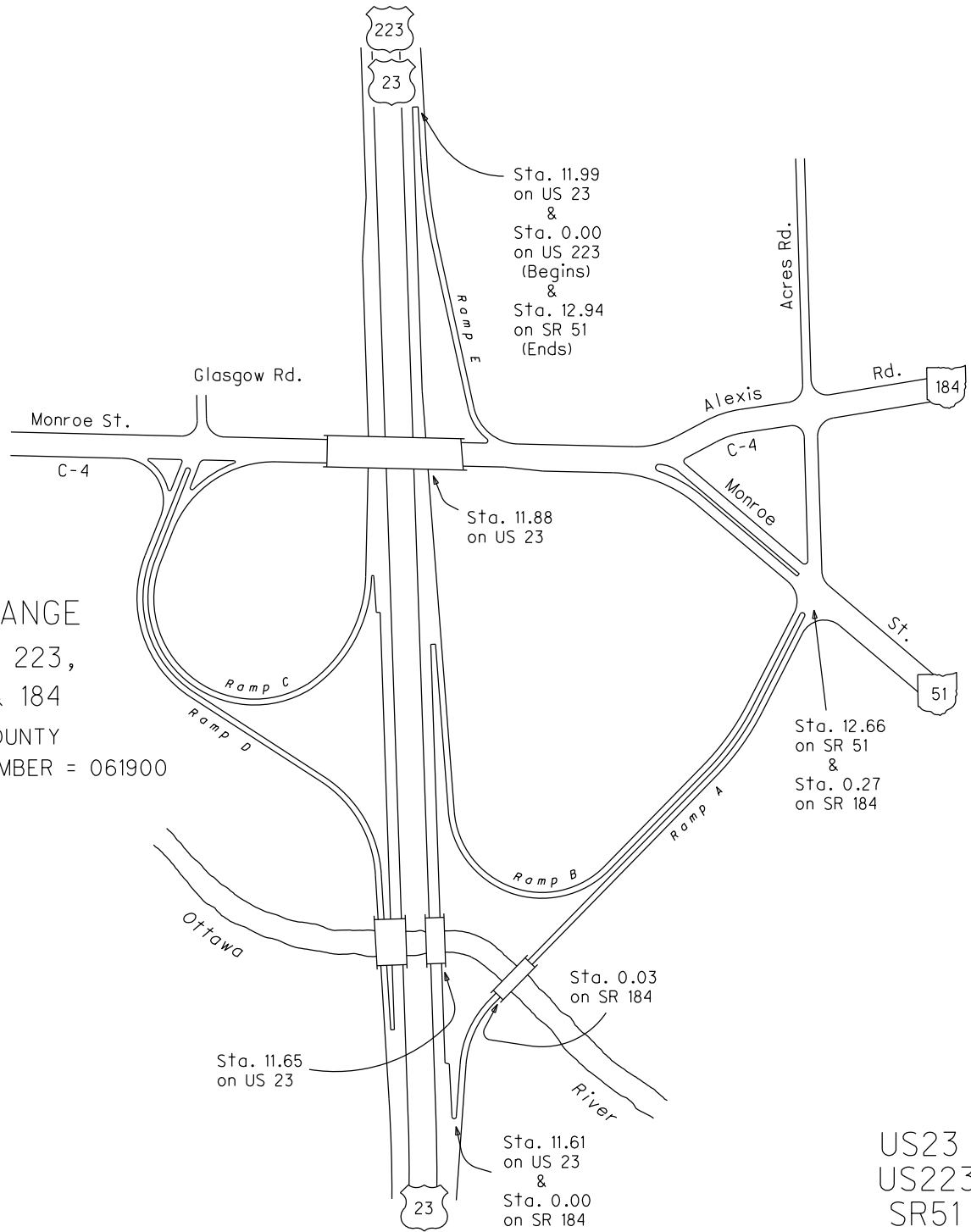

US23 SHEET 3 OF 3  
US223 SHEET 1 OF 1  
SR51 SHEET 3 OF 3  
SR184 SHEET 1 OF 3

REVISED Jan 2014

# SLUCSR00184\*\*C

State True Log

County True Log

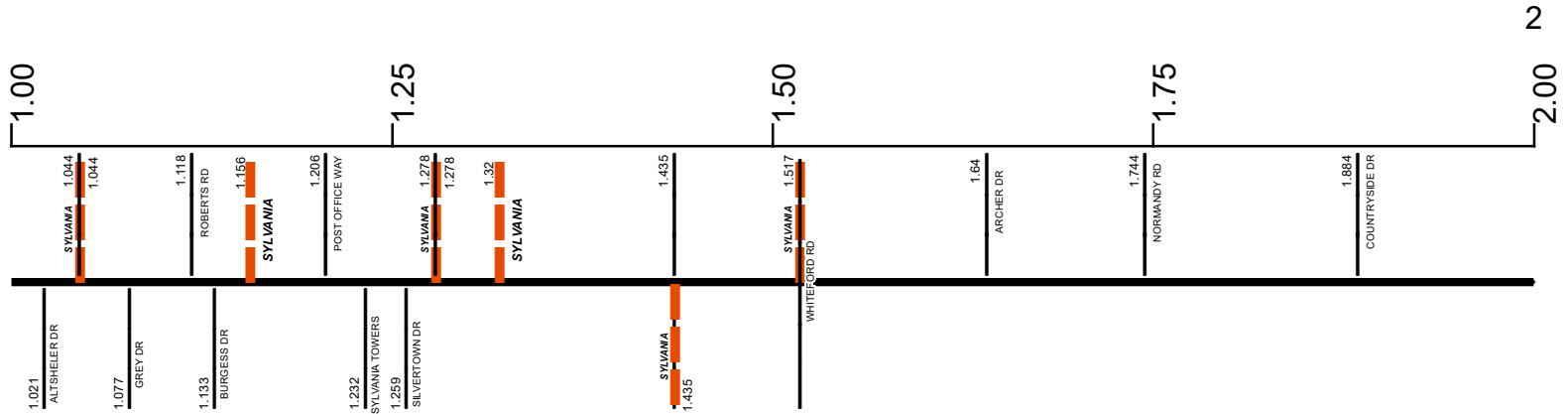

**Surface Type & Width (Left / Right)**

G 54'  
0.529 - 3.694

**Base Type (Left / Right)**

N  
0.529 - 3.694

**Shoulder Type & Width (Left / Right)**

1 (0'/0')  
0 - 10.114

**Through Lanes**

4  
0.529 - 10.114

**Street Name**

W ALEXIS RD  
0.529 - 7.663

- Non-divided Highway
- Divided Highway
- Secondary Segment
- Corporation
- Bridge (on route)
- Underpass
- Overpass
- Railroad (at grade)
- Railroad (underpass)
- Railroad (overpass)
- Intersection

Created on: 7/1/2025

transportation.ohio.gov

Prepared by  
The Ohio Department of Transportation  
Office of Technical Services  
Roadway Information

# SLUCSR00184\*\*C

State True Log  
County True Log

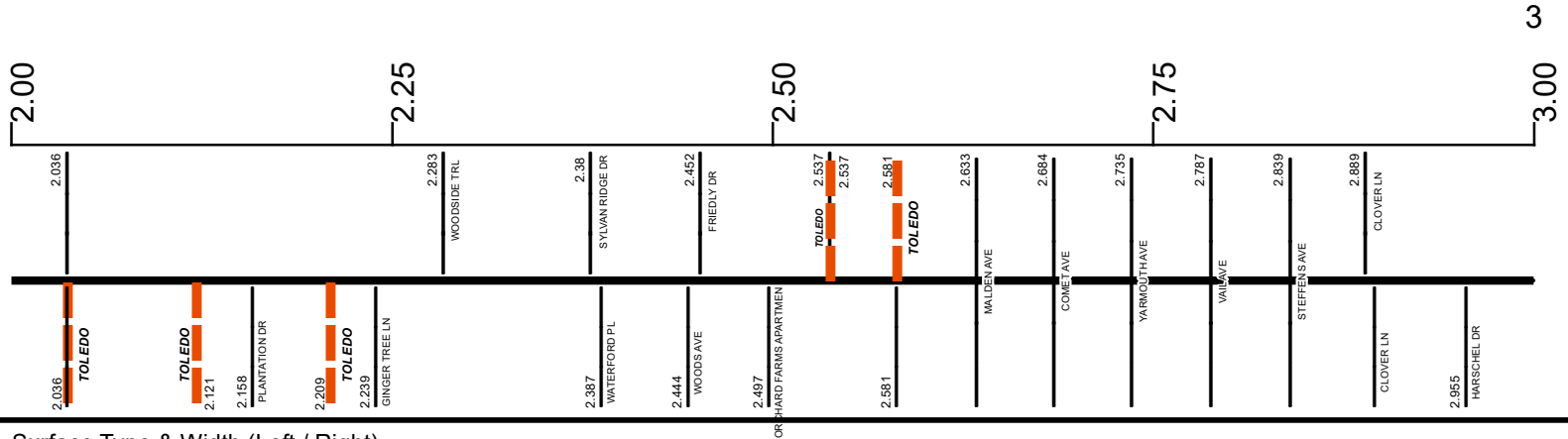

Surface Type & Width (Left / Right)	G 54' 0.529 - 3.694
Base Type (Left / Right)	N 0.529 - 3.694
Shoulder Type & Width (Left / Right)	1 (0'/0') 0 - 10.114
Resurface Year	2020 2.044 - 5.693
Through Lanes	4 0.529 - 10.114
Street Name	W ALEXIS RD 0.529 - 7.663

- Non-divided Highway
- Divided Highway
- Secondary Segment
- Corporation
- Bridge (on route)
- Underpass
- Overpass
- Railroad (at grade)
- Railroad (underpass)
- Railroad (overpass)
- Intersection

Created on: 7/1/2025



transportation.ohio.gov  
Prepared by  
The Ohio Department of Transportation  
Office of Technical Services  
Roadway Information

# SLUCSR00184\*\*C

State True Log

County True Log

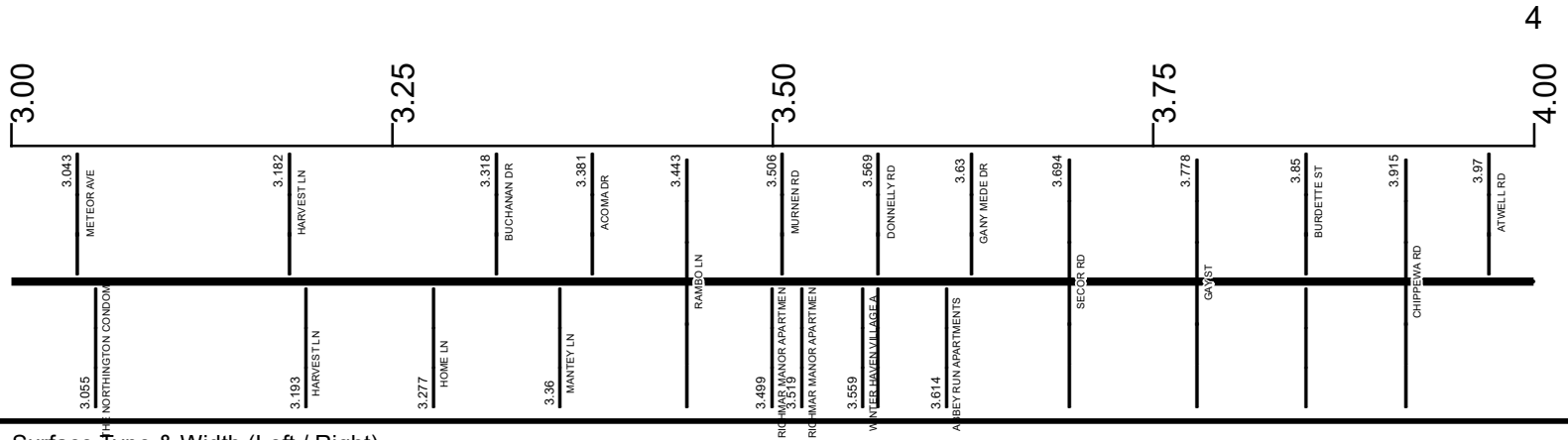

**Surface Type & Width (Left / Right)**

G 54'	G (18'/36')
0.529 - 3.694	3.694 - 6.133

**Base Type (Left / Right)**

N	N / P
0.529 - 3.694	3.694 - 7.663

**Shoulder Type & Width (Left / Right)**

1 (0'/0')	
0 - 10.114	

**Resurface Year**

2020	
2.044 - 5.693	

**Through Lanes**

4	
0.529 - 10.114	

**Street Name**

W ALEXIS RD	
0.529 - 7.663	

- Non-divided Highway
- Divided Highway
- Secondary Segment
- Corporation
- Bridge (on route)
- Underpass
- Overpass
- Railroad (at grade)
- Railroad (underpass)
- Railroad (overpass)
- Intersection

Created on: 7/1/2025

transportation.ohio.gov

Prepared by  
The Ohio Department of Transportation  
Office of Technical Services  
Roadway Information

# SLUCSR00184\*\*C

State True Log

County True Log

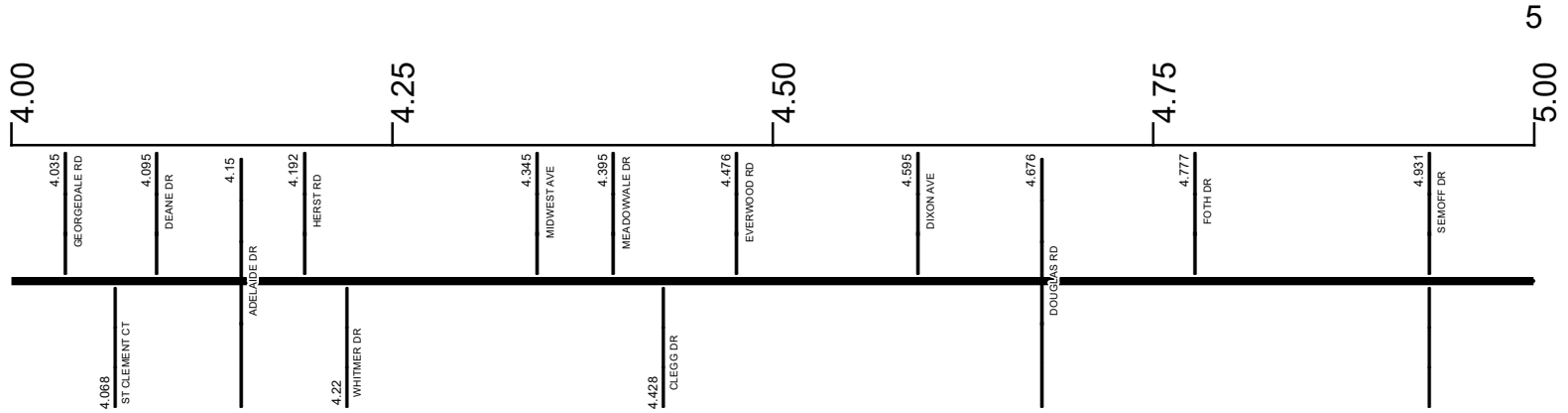

**Surface Type & Width (Left / Right)**

G (18'/36')  
3.694 - 6.133

**Base Type (Left / Right)**

N / P  
3.694 - 7.663

**Shoulder Type & Width (Left / Right)**

1 (0'/0')  
0 - 10.114

**Resurface Year**

2020

**Through Lanes**

4

**Street Name**

W ALEXIS RD  
0.529 - 7.663

- Non-divided Highway
  Bridge (on route)
  Railroad (at grade)
  Intersection
- Divided Highway
  Underpass
  Railroad (underpass)
- Secondary Segment
  Overpass
  Railroad (overpass)
- Corporation**

Created on: 7/1/2025



transportation.ohio.gov

Prepared by  
The Ohio Department of Transportation  
Office of Technical Services  
Roadway Information

# SLUCSR00184\*\*C

State True Log

County True Log

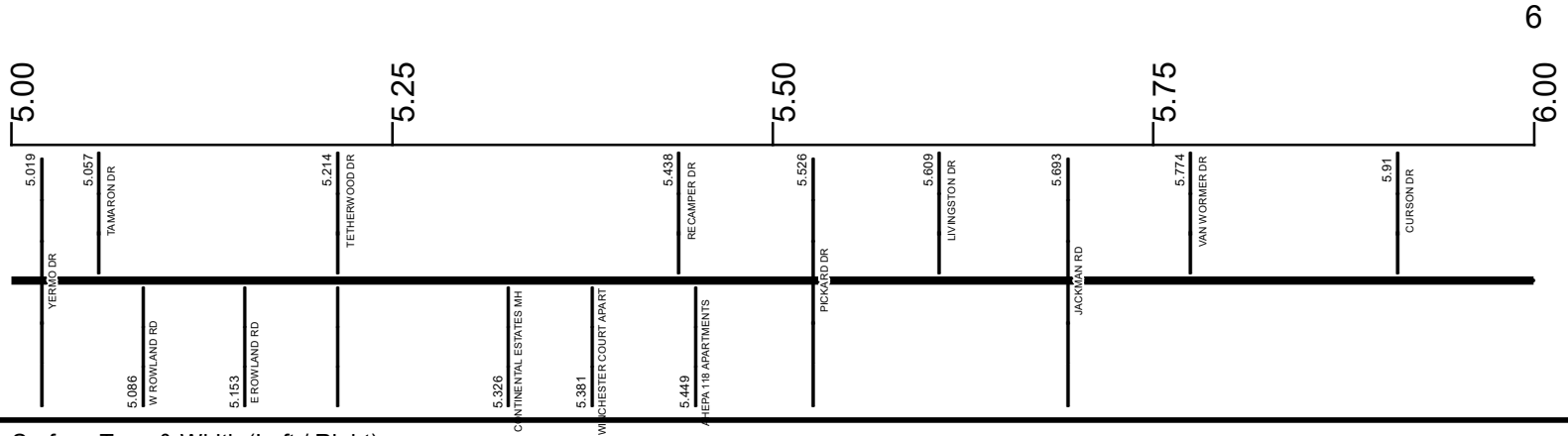

Surface Type & Width (Left / Right)	G (18'/36')
	3.694 - 6.133
Base Type (Left / Right)	N / P
	3.694 - 7.663
Shoulder Type & Width (Left / Right)	1 (0'/0')
	0 - 10.114
Resurface Year	2020
	2.044 - 5.693
Through Lanes	4
	0.529 - 10.114
Street Name	W ALEXIS RD
	0.529 - 7.663

- Non-divided Highway
- Divided Highway
- Secondary Segment
- Corporation
- Bridge (on route)
- Underpass
- Overpass
- Railroad (at grade)
- Railroad (underpass)
- Railroad (overpass)
- Intersection

Created on: 7/1/2025

transportation.ohio.gov

Prepared by  
The Ohio Department of Transportation  
Office of Technical Services  
Roadway Information

# SLUCSR00184\*\*C

State True Log

County True Log

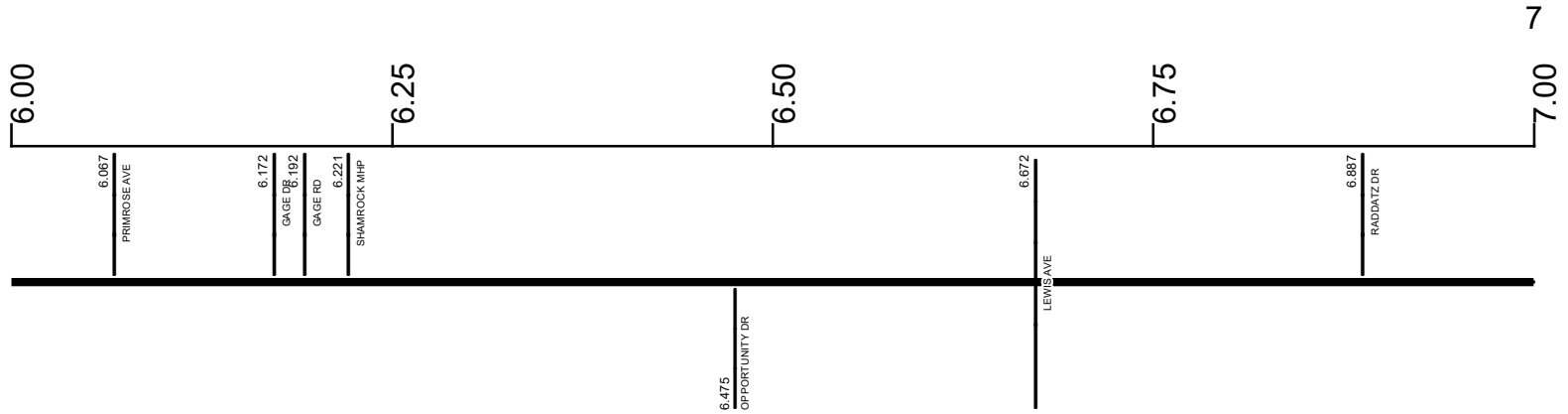

**Surface Type & Width (Left / Right)**

G (18'/36') 3.694 - 6.133	G (42'/36') 6.133 - 7.663
------------------------------	------------------------------

**Base Type (Left / Right)**

N / P 3.694 - 7.663	
------------------------	--

**Shoulder Type & Width (Left / Right)**

1 (0'/0') 0 - 10.114	
-------------------------	--

**Resurface Year**

2022 6.51 - 6.905
----------------------

**Through Lanes**

4 0.529 - 10.114	
---------------------	--

**Street Name**

W ALEXIS RD 0.529 - 7.663	
------------------------------	--

- Non-divided Highway
- Divided Highway
- Secondary Segment
- Corporation
- Bridge (on route)
- Underpass
- Overpass
- Railroad (at grade)
- Railroad (underpass)
- Railroad (overpass)
- Intersection

Created on: 7/1/2025

transportation.ohio.gov  
Prepared by  
The Ohio Department of Transportation  
Office of Technical Services  
Roadway Information

# SLUCSR00184\*\*C

State True Log

County True Log

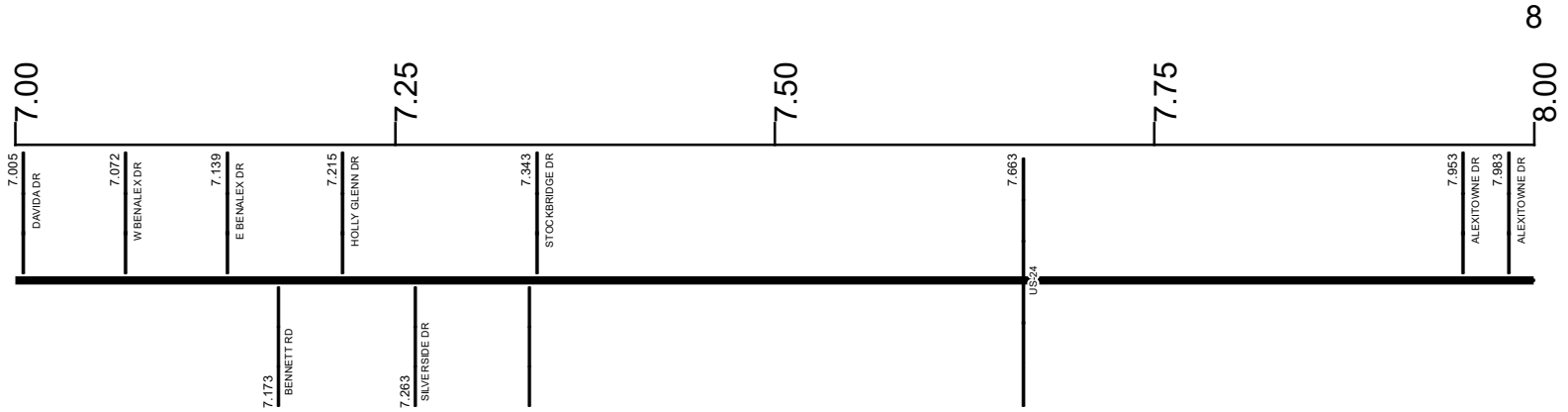

**Surface Type & Width (Left / Right)**

G (42'/36')	G 70'
6.133 - 7.663	7.663 - 8.243

**Base Type (Left / Right)**

N / P	N
3.694 - 7.663	7.663 - 8.243

**Shoulder Type & Width (Left / Right)**

	1 (0'/0')
	0 - 10.114

**Through Lanes**

	4
	0.529 - 10.114

**Street Name**

W ALEXIS RD	E ALEXIS RD
0.529 - 7.663	7.663 - 10.114

- Non-divided Highway
- Divided Highway
- Secondary Segment
- Corporation
- Bridge (on route)
- Underpass
- Overpass
- Railroad (at grade)
- Railroad (underpass)
- Railroad (overpass)
- Intersection

Created on: 7/1/2025

transportation.ohio.gov

Prepared by  
The Ohio Department of Transportation  
Office of Technical Services  
Roadway Information

# SLUCSR00184\*\*C

State True Log  
County True Log

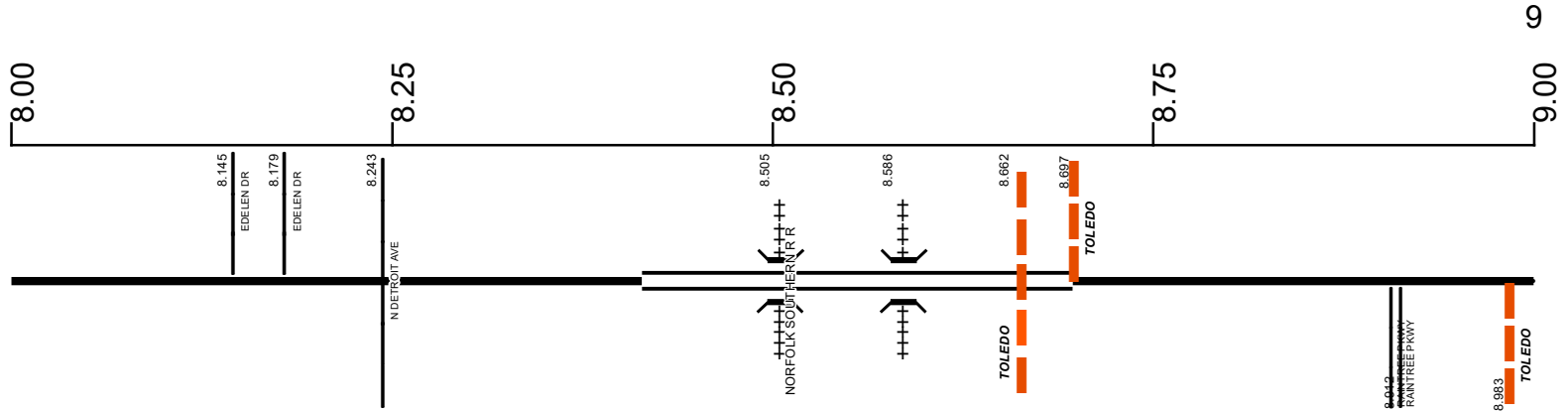

Surface Type & Width (Left / Right)	
G 70' 7.663 - 8.243	G 52' 8.243 - 8.717
G 54'      G 66' 8.717 - 8.898      8.898 - 9.2	
Base Type (Left / Right)	
N 7.663 - 8.243	L 8.243 - 10.447
Shoulder Type & Width (Left / Right)	
1 (0'/0') 0 - 10.114	
Median Type and Width	
3 (2') 8.414 - 8.697	
Through Lanes	
4 0.529 - 10.114	
Street Name	
E ALEXIS RD 7.663 - 10.114	

Non-divided Highway	Bridge (on route)	Railroad (at grade)	Intersection
Divided Highway	Underpass	Railroad (underpass)	
Secondary Segment	Overpass	Railroad (overpass)	
Corporation			

Created on: 7/1/2025

transportation.ohio.gov

Prepared by  
The Ohio Department of Transportation  
Office of Technical Services  
Roadway Information

# SLUCSR00184\*\*C

State True  
Log

County True  
Log

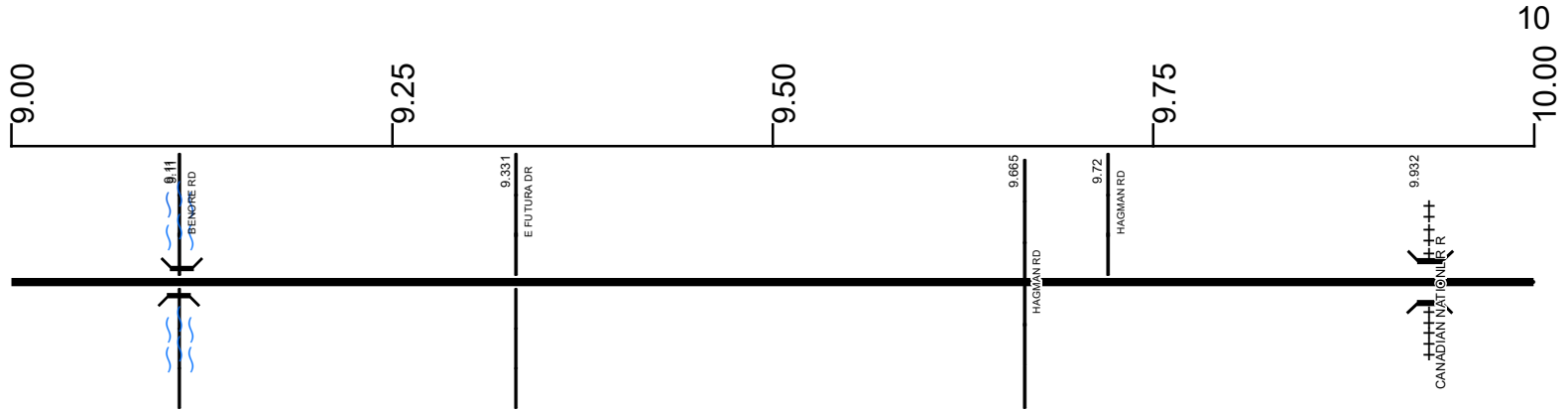

**Surface Type & Width (Left / Right)**

G 66'	G 60'
8.898 - 9.2	9.2 - 10.114

**Base Type (Left / Right)**

L	
8.243 - 10.447	

**Shoulder Type & Width (Left / Right)**

1 (0/0')	
0 - 10.114	

**Through Lanes**

4	
0.529 - 10.114	

**Street Name**

E ALEXIS RD	
7.663 - 10.114	

- Non-divided Highway
- Divided Highway
- Secondary Segment
- Corporation
- Bridge (on route)
- Underpass
- Overpass
- Railroad (at grade)
- Railroad (underpass)
- Railroad (overpass)
- Intersection

Created on: 7/1/2025

transportation.ohio.gov

Prepared by  
The Ohio Department of Transportation  
Office of Technical Services  
Roadway Information

# SLUCSR00184\*\*C

10.447

State True Log

County True Log

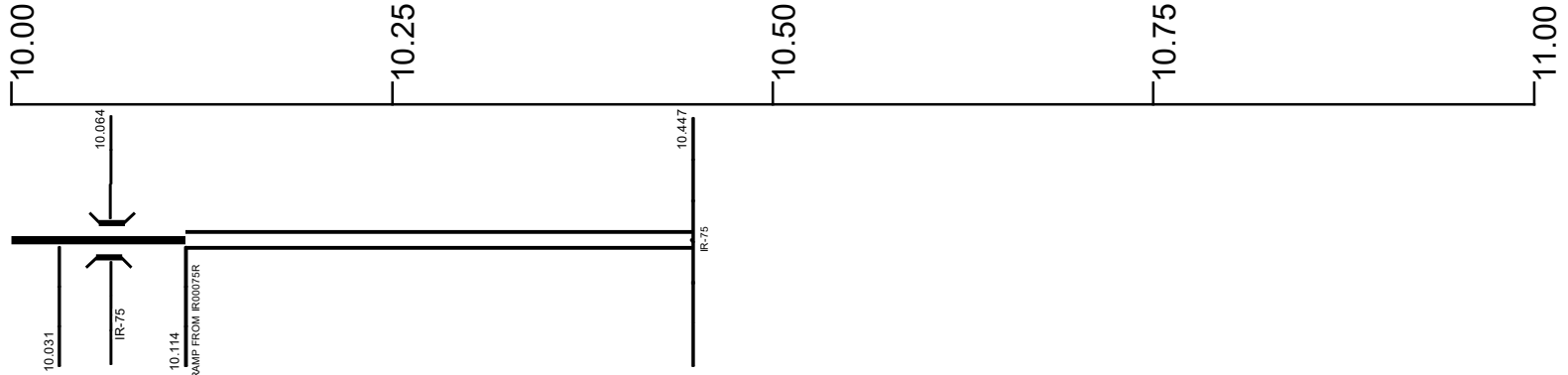

### Surface Type & Width (Left / Right)

G 60'	G 32'
9.2 - 10.114	10.114 - 10.447

### Base Type (Left / Right)

L
8.243 - 10.447

### Shoulder Type & Width (Left / Right)

1 (0'/0')	2 (0'/0')
0 - 10.114	10.114 - 10.447

### Median Type and Width

2 (99')
10.114 - 10.447

### Through Lanes

4	2
0.529 - 10.114	10.114 - 10.447

### Street Name

E ALEXIS RD	ALEXIS RD TO I 75 N
7.663 - 10.114	10.114 - 10.447

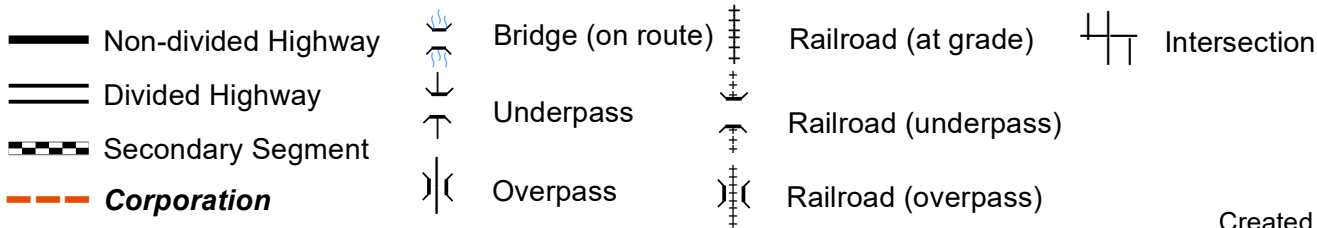

Created on: 7/1/2025



transportation.ohio.gov

Prepared by

The Ohio Department of Transportation  
Office of Technical Services  
Roadway Information

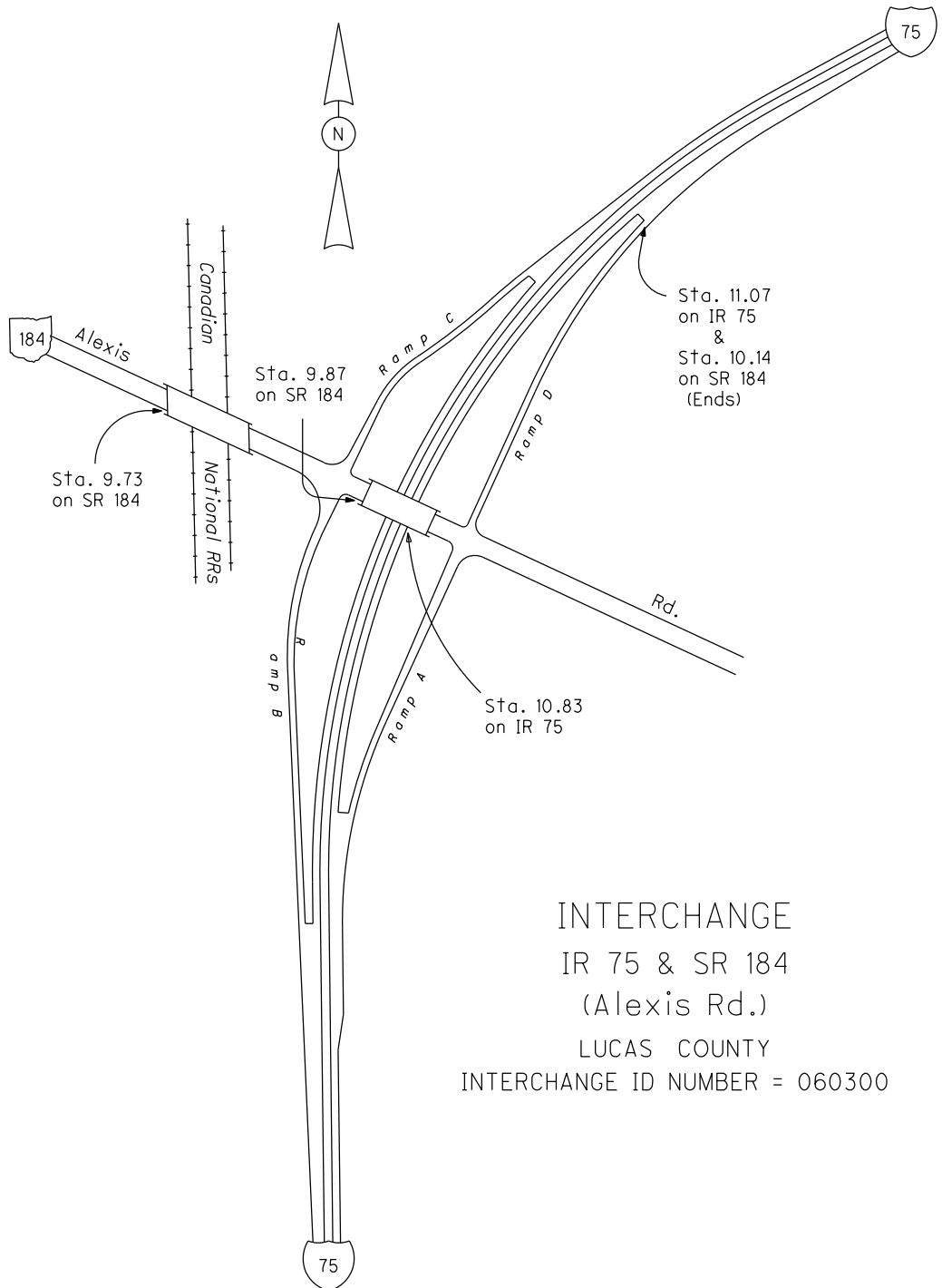

INTERCHANGE  
 IR 75 & SR 184  
 (Alexis Rd.)  
 LUCAS COUNTY  
 INTERCHANGE ID NUMBER = 060300

## Historical Project List for SLUCSR00184\*\*C

Begin Measure	End Measure	Project ID Number	Construction Completion Date	Treatment Category	Treatment Type
0.164	0.206	113685	10-2022	Preventive Maintenance	30-Microsurfacing
0.458	2.036	85285	5-2011	Minor Rehabilitation	60-AC Overlay w/Rpr
0.539	2.026	99662	9-2019	Minor Rehabilitation	60-AC Overlay w/Rpr
2.026	5.673	100196	10-2020	Minor Rehabilitation	60-AC Overlay w/Rpr
6.672	7.663	93915	7-2014	Minor Rehabilitation	60-AC Overlay w/Rpr
9.952	10.073	22252	7-2007	Minor Rehabilitation	60-AC Overlay w/Rpr

# Roadway Codes

## Access Control Journalized

- F - Full Access Control
- L - Limited Access Control
- N - No Access Control

## Access Control Operational

- 1 - Full Access Control
- 2 - Partial Access Control
- 3 - No Access Control

## Base Type

- F - Crack and Seat
- H - Rubblize and Roll
- I - Aggregate Base 304 or Traffic Compacted
- K - Water Bound Macadam
- L - Bituminous Concrete Mix or Penetration Macadam
- N - Plain Concrete
- P - Reinforced Concrete
- R - Brick (Flexible)
- T - Brick (Rigid)

## Direction of Travel

- B - Both (Two-way)
- F - One-way Cardinal
- T - One-way Non-cardinal

## Facility Type

- 1 - One-way Roadway
- 2 - Two-way Roadway
- 4 - Ramp
- 5 - Non-mainline
- 6 - Non-inventory Direction
- 7 - Planned / Unbuilt

## Historical Federal Aid Indicator

- N - Not a FAP Route
- Y - FAP Route

## Functional Classification

- 01 - Interstate
- 02 - Principal Arterial (Freeways)
- 03 - Principal Arterial (Other)
- 04 - Minor Arterial
- 05 - Major Collector
- 06 - Minor Collector
- 07 - Local

## Leave / Reenter Indicator

- Y - Route leaves/reenters at this point
- N - Route does not leave/reenter at this point

## Median Type

- 1 - None
- 2 - Unprotected
- 3 - Curbed
- 4 - Positive Barrier (Unspecified)
- 5 - Positive Barrier (Flexible)
- 6 - Positive Barrier (Semi-rigid)
- 7 - Positive Barrier (Rigid)

## NHS

- N - National Highway System
- H - Congressional Corridor
- 2 - Major Airport
- 3 - Major Port Facility
- 4 - Major Amtrak Station
- 5 - Major Rail / Truck Terminal
- 6 - Major Intercity Bus Terminal
- 7 - Major Public Transit / Multi-modal Passenger Terminal
- 8 - Major Pipeline Terminal
- 9 - Major Ferry Terminal

## Priority System

- G - General
- P - Priority System
- U - Urban

## Scenic Byway Code

- A - All American Road
- N - National Scenic Byway
- S - State Scenic Byway

## Shoulder Type

- 1 - None
- 2 - Surfaced shoulder exists (bituminous concrete {AC})
- 3 - Surfaced shoulder exists (Portland Cement Concrete {PCC})
- 4 - Stabilized shoulder exists (gravel or other granular material)
- 5 - Combination shoulder exists (two or more surface types)
- 6 - Earth shoulder exists
- 7 - Barrier curb exists; no shoulder in front of curb

## Surface Type

- A - Combination
- B - Brick
- C - Continuous Reinforced Concrete
- D - Reinforced Concrete
- E - Plain Concrete
- G - Bituminous Concrete
- I - Chipseal on Granular
- K - Open Graded Bituminous
- L - Chipseal or Micro
- M - Gravel
- U - Unimproved
- X - Right of Way Only